

Electronics World

NOVEMBER, 1966
60 CENTS

Directory of Most Popular, Low-Priced VIDEO TAPE RECORDERS

THE MAGNETIC TAPE CARTRIDGE
BREAKS INTO THE HOME & CAR MARKETS

HOW TO SELECT AND SPECIFY POWER CHOKES & COILS

**NEW LINEAR IC's for
CONSUMER
PRODUCTS**

- TRANSISTORS
- DIODES
- DIODE CAPACITORS
- RESISTORS
- METALIZING

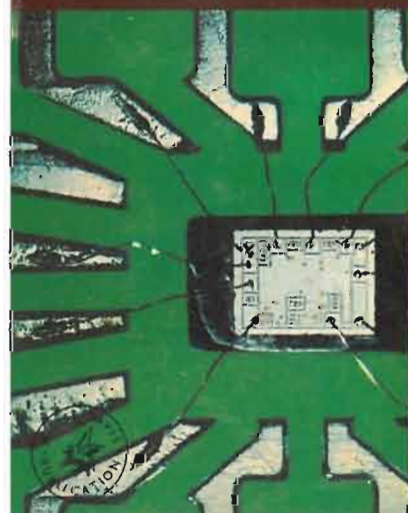
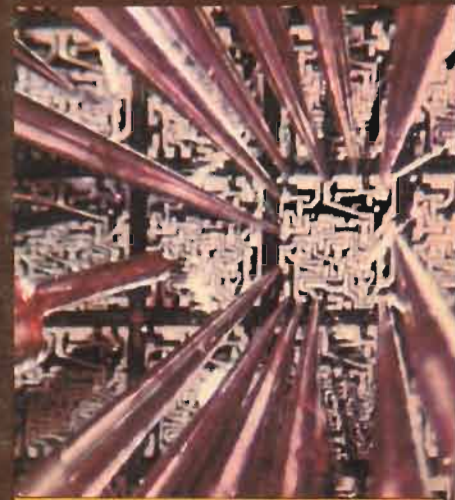
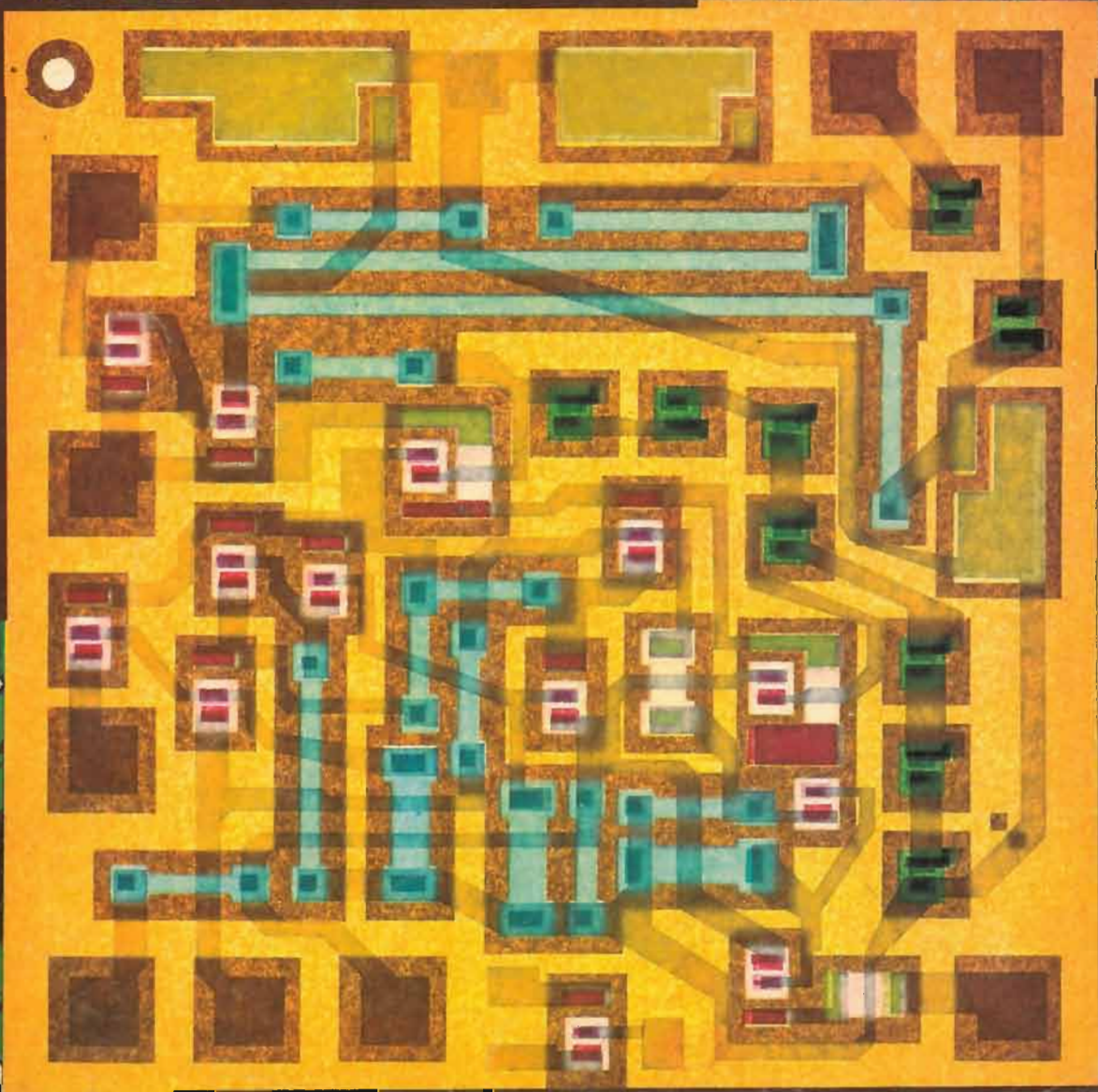



The microphone
with backbone...

MODEL 674

now has a
staunch new
companion!

MODEL 676

ⓔ In just a few short months the Electro-Voice Model 676 has gained quite a reputation as a problem solver—no matter what the odds. Now the 676 has a teammate. The Model 674 has the same unique backbone that rejects unwanted sound...an exclusive with Continuously Variable-D (CV-D)TM microphones from Electro-Voice. And the improvement in performance is dramatic.

Troubled with feedback or interfering noise pickup? Most cardioid microphones cancel best at only one frequency—but CV-D* insures a useful cardioid pattern over the entire response range. And its small size means the pickup is symmetrical on any axis.

Bothered by rumble, reverberation, or loss of presence? A recessed switch lets you attenuate bass (by 5 or 10 db at 100 Hz) to stop problems at their source. And there's no unwanted bass

boost when performers work ultra-close. CV-D eliminates this "proximity effect" so common to other cardioids.

Wind and shock noise are almost completely shut out by the CV-D design. Efficient screening protects against damaging dust and magnetic particles, and guards against annoying "pops".

As for overall sound quality, only expensive professional models compare with the 676 and 674. The exclusive Acoustalloy[®] diaphragm gets the credit. It's indestructible—yet low in mass to give you smooth, peak-free, wide-range response with high output.

The Model 676 slips easily into its 1" stand clamp for quick, positive mounting. The fine balance and shorter length of the 676, and absence of an on-off switch makes it ideal for hand-held or suspended applications.

The Model 674 offers identical performance but is provided with a stand-

ard mounting stud and on-off switch. Either high- or balanced low-impedance output can be selected at the cable of both microphones.

Choose the 676 or 674 in satin chrome or non-reflecting gray finish for just \$100.00. Gold finish can be ordered for \$10.00 more (list prices less normal trade discounts). There is no better way to stand up to your toughest sound pickup problems. Proof is waiting at your nearby E-V sound specialist's. Or write for free catalog of Electro-Voice microphones today.

An important footnote: There is no time limit to our warranty! If an E-V microphone should fail, just send it to us. If there's even a hint that our workmanship or materials weren't up to par, the repair is no charge—even decades from now! Fair enough?

*Patent No. 3,115,207

ELECTRO-VOICE, INC., Dept. 1162N, 629 Cecil Street, Buchanan, Michigan 49107.

Electro-Voice
SETTING NEW STANDARDS IN SOUND

Crime does pay!



Every 40 seconds a burglary takes place in the United States.

TECHNICAL INFORMATION

The RADAR SENTRY ALARM is a complete U.H.F. Doppler Radar System which saturates the entire protected area with invisible r.f. microwaves. It provides complete wall to wall—floor to ceiling protection for an area of up to 5,000 square feet. Without human movement in the protected area, the microwave signal remains stable. Any human movement (operation is unaffected by rodents and small animals) in the area causes the doppler signal to change frequency approximately 2 to 4 cps. An ultra-stable low frequency detector senses this small frequency change, amplifies it and triggers the police type siren—which is heard up to a half mile away.

In addition, the RADAR SENTRY ALARM's protection can be extended to other areas with the use of the following optional accessories:

- remote detectors for extending coverage to over 10,000 sq. ft.
- rate of rise fire detector U.L. approved for 2,500 sq. ft. of coverage each (no limit on the number of remote detectors that can be used)
- hold-up alarm
- central station or police station transmitter and receiver (used with a leased telephone line)
- relay unit for activating house lights
- battery operated horn or bell which sounds in the event of: powerline failure; equipment malfunction or tampering

At that rate, it's a multi-million dollar a year business...for burglars.

And an even better business opportunity for you.

Why? Because burglary can be stopped...with an effective alarm system.

In fact, police and insurance officials have proved that an alarm system reduces, and in many cases, eliminates losses—even helps police apprehend the criminal.

Here's where you come in.

Only a small percentage of the more than 100 million buildings—stores, offices, factories, schools, churches and homes are protected by an effective alarm system.

That means virtually every home, every business is a prospect. You can sell them!

And you don't have to be a super-salesman to sell the best protection available—a Radar Sentry Alarm unit. All you have to do is demonstrate it...it sells itself.

A glance at the technical information shows why.

It's the most unique and effective alarm system ever invented.

And here's the proof.

In the past six years, thousands of RADAR SENTRY ALARM units have been sold in the Detroit, Michigan area alone—sold by men like yourself on a part-time and full-time basis.

Here are just a few customers who are protected by RADAR SENTRY ALARMS:

U.S. Government
U.S. Air Force
Detroit Board of Education
Hundreds of Churches,
Banks, Businesses and
Homes.

Everyone is a prospect.

So take advantage of your profession! Put your technical knowledge and experience to work for you in a totally new area—an area that will make money for you!

Don't wait!

Let us prove that crime does pay.

Become a distributor.

Write now for free details.

RADAR SENTRY ALARM



Mail to: RADAR DEVICES MANUFACTURING CORP.
22033 Harper Ave., St. Clair Shores, Michigan 48080



Please tell me how I can have a business of my own distributing Radar Sentry Alarm Systems. I understand there is no obligation.

Name _____

Address _____

City _____

State & Code _____

EW-11

CIRCLE NO. 92 ON READER SERVICE CARD



ANNOUNCING A MAJOR ANTENNA
ADVANCE FROM JERROLD

PARALOG *Plus*™

Plus GAIN ■ Plus FLATNESS ■ Plus MATCH

Why is color harder to receive than black & white? Because color detecting circuits cannot tolerate phase shifts caused by multipath reception, tilted response, or mismatch.

The new Jerrold Paralog-Plus improves color reception three ways:

1. **Plus Gain**—to provide sharper directivity to eliminate multipath reception.
2. **Plus Flatness**—to eliminate tilts which cause incorrect colors on the TV screen. Industry experts say that color antennas must be flat within ± 2 db. Paralog-Plus antennas are flat within ± 1 db per channel.
3. **Plus Match**—to prevent color-distorting phase shifts.

How does Paralog-Plus give you these exclusive color features? A unique Bi Modal Director system actually works on high and low band channels simultaneously, making each element serve double duty. Also, you get choice of 75 and 300 ohm coaxial outputs, plus excellent gain over the entire FM band. For life-like color in your home, try the Paralog-Plus.

DISTRIBUTOR SALES DIVISION
401 Walnut St., Philadelphia, Pa. 19105

JERROLD

CIRCLE NO. 109 ON READER SERVICE CARD

ELECTRONICS WORLD

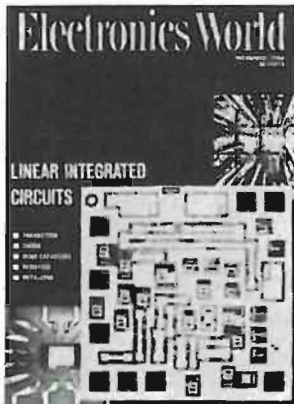

THIS MONTH'S COVER shows an artist's rendering (made from the 6 original diffusion masks) of the RCA linear integrated circuit being used as the intercarrier audio system in current RCA TV sets. The tiny circuit, 50 mils on each side, incorporates 12 transistors, 15 resistors, 9 diodes, and 3 diode capacitors. Over-all operation of this device was covered in our June, 1966 issue. Before the chips are separated from the master slice, each chip is automatically tested (as shown in the upper-right photo) by a test set having 12 fine-pointed test probes that contact certain terminals to measure basic circuit parameters. The IC at the lower left is a G-E linear IC showing typical mounting and lead configuration as used in the company's new low-cost plastic flat pack. . . Photos courtesy of RCA and General Electric Company.



Publisher
PHILLIP T. HEFFERNAN

Editor
WM. A. STOCKLIN

Technical Editor
MILTON S. SNITZER

Associate Editors
LESLIE SOLOMON
P. B. HOEFER

Assistant Editor
MARSHA JACOBS

Contributing Editors
WALTER H. BUCHSBAUM
Prof. ARTHUR H. SEIDMAN

Art Editor
RICHARD KELLY

Art and Drafting Dept.
J. A. GOLANEK

Advertising Sales Manager
LAWRENCE SPORN

Advertising Service Manager
ARDYS C. MORAN

November, 1966

Electronics World

NOVEMBER 1966

VOL. 76, No. 5

CONTENTS

- 23 Linear Integrated Circuits** *B. V. Vonderschmitt & R. L. Sanquini*
Here are some practical ground rules to follow for the circuit engineer who is now designing consumer products. A whole new way of thinking about circuits is required.
- 27 Line-Operated Transistor TV Sets: Magnavox** *Walter H. Buchsbaum*
- 28 Recent Developments in Electronics**
- 30 The Tape Cartridge Comes of Age** *Leonard Coplen & Robert Johns*
An up-to-the-minute report on the new magnetic tape cartridges which may be the most important innovation in musical entertainment for the car and the home since the LP.
- 33 Power Inductors** *Robert E. Coy*
A guide to the selection of the proper iron-core choke coil for power-supply filtering, as a charging choke for pulse networks, and for interference reduction.
- 36 Directory of Most Popular, Low-Priced Video Tape Recorders**
- 38 Linear Integrated Circuits: What's Available?** *Donald E. Lancaster*
- 43 High-Quality Square-Wave Generator** *C. J. Ulrick*
- 44 World's First Single-Chip Integrated-Circuit Radio** *J.A. Cacciola & E.Q. Carr*
Here are the latest, complete technical details on the first mass-produced AM radio to use a single IC to replace all the active components in the circuit. All 125 dB of r.f. and a.f. gain required is packed into a tiny 35- by 40-mil silicon chip.
- 47 Designing Silicon-Transistor Hi-Fi Amplifiers** *R. D. Gold & J. C. Sondermeyer*
Part 3. Performance of Practical Circuits
- 56 Diode Meter Protectors** *A. A. Mangieri*
- 85 Japanese IC's**
- 88 Selecting a Sweep Frequency Generator** *Samuel C. Allen*
- 105 Scope D.C. Shift** *Donald Ludwig*
-
- 14 EW Lab Tested**
Kenwood TK-60 Stereo Receiver
Marantz Model 7T Preamplifier
- 58 The 1966 G.I. Bill** *John Frye*
- 68 Test Equipment Product Report**
Triplet Model 630-APLK V.O.M.
Eico Model 888 Engine Analyzer
Acopian Model K55 Regulated Power Supply
-
- ### MONTHLY FEATURES
- 4 Coming Next Month** **77 Electronic Crosswords**
- 6 Letters from Our Readers** **86 Book Reviews**
- 66 Radio & TV News** **100 New Products & Literature**

Electronics World: Published monthly by Ziff-Davis Publishing Company at 307 North Michigan Ave., Chicago, Illinois 60601. One year subscription \$6.00. Second Class Postage paid at Chicago, Illinois and at additional mailing offices. Subscription service: Portland Place, Boulder, Colorado 80302.
Copyright © 1966 by Ziff-Davis Publishing Company. All rights reserved.

NEW  DLCT 7.5 WATTS	NEW  DLC 7.5 WATTS
NEW  8M2CT 15 WATTS	NEW  8M2C 15 WATTS
NEW  CORBREFLEX 30/30T 30 WATTS	NEW  SH-30/30T 30 WATTS

**NEW FROM
UNIVERSITY
SOUND
6
additions
to the world's
greatest
selection of
paging-talkback
speakers!**

What's your pleasure? Communications to fit the whisper of a medium-sized office . . . or the roar of Grand Central Station? University has 'em! Some with full frequency response for background music. All with the crisp, natural voice quality so unique to University. Write for our new '66/'67 PA Catalog today.

U LISTEN—UNIVERSITY SOUNDS BETTER
UNIVERSITY SOUND
A DIVISION OF LTV LING ALTEC, INC.
Dept. L-65, P.O. Box 1056, Oklahoma City, Okla.
CIRCLE NO. 80 ON READER SERVICE CARD

COMING NEXT MONTH

SPECIAL FEATURE ARTICLES ON: COLOR TV



Color-TV Broadcasting—NBC provides a behind-the-scenes look at color broadcasting from an electronics viewpoint. The article covers engineering problems, studio techniques, camera and lighting problems, video tape recordings, outside pickups.
The Modern Shadow-Mask Color-TV Picture Tube—R. K. Gessford of Sylvania's Tube Div. brings us up-to-date on today's new high-efficiency color tubes.
Color-TV Signal Generators—Here is a rundown on virtually all of the available color generators—with pertinent electrical and mechanical specs for each model. This is presented in tabular form for easy comparison and reference.

PLUS....

Electronic Metal Locators—An in-depth survey covering models available to the sportsman and treasure hunter. Comparative characteristics and performance data are provided on beat-frequency, induction-balance, and transmitter-receiver types along with a directory of metal locator manufacturers.

CRYSTAL-SAVING FREQUENCY SYNTHESIZER

A novel method for generating many crystal-controlled frequencies at a great saving of crystals is described by F. P. Smith of Narco. Applications include FM receivers and CB transceivers as well as aircraft communications equipment.

CRYOGENIC LIQUID LEVEL CONTROLS

The increasingly widespread application of

All these and many more interesting and informative articles will be yours in the December issue of **ELECTRONICS WORLD** . . . on sale November 17th.

cryogens in industry has spawned a whole new family of controls for maintaining the level of cryogenic liquids in their reservoirs. W. W. Schopp of the Lawrence Radiation Lab describes some of them.

FIELD-EFFECT TRANSISTOR CIRCUITS

Six practical circuits are diagrammed and described in this article prepared especially for those interested in learning about FET's by working with them.

ZIFF-DAVIS PUBLISHING COMPANY

William B. Ziff
Chairman of the Board (1946-1953)

William Ziff
President

W. Bradford Briggs
Executive Vice President

Hershel B. Sarbin
Vice President and General Manager

Philip Sine
Financial Vice President

Walter S. Mills, Jr.
Vice President, Circulation

Stanley R. Greenfield
Vice President, Marketing

Phillip T. Heffernan
Vice President, Electronics Division

Frank Pomerantz
Vice President, Creative Services

Arthur W. Butzow
Vice President, Production

Edward D. Muhlfeld
Vice President, Aviation Division

Editorial and Executive Offices
One Park Avenue
New York, New York 10016 212 679-7200

NEW YORK OFFICE 212 679-7200
James J. Sullivan
Joseph E. Halloran

MIDWESTERN OFFICE
307 North Michigan Avenue
Chicago, Illinois 60601 312 726-0892
Midwestern Advertising Manager, Royce Richard

WESTERN OFFICE
9025 Wilshire Boulevard
Beverly Hills, California 90211
213 CRestview 4-0265; BRadshaw 2-1161
Western Advertising Manager, Bud Dean

JAPAN
James Yagi
c/o Fukushima
19-14 Minami 3-chrome
Koenji, Suginomi-ku
Tokyo, Japan

CIRCULATION OFFICE
Portland Place, Boulder, Colorado 80302



Member
Audit Bureau of
Circulations

Radio & TV News • Radio News • Radio-Electronic Engineering Trademarks Reg. U.S. Pat. Off.
SUBSCRIPTION SERVICE: All subscription correspondence should be addressed to Electronics World, Circulation Department, Portland Place, Boulder, Colorado 80302. Please allow at least six weeks for change of address. Include your old address, as well as new—enclosing if possible an address label from a recent issue.

EDITORIAL CONTRIBUTIONS must be accompanied by return postage and will be handled with reasonable care; however publisher assumes no responsibility for return or safety of art work, photographs, or manuscripts.

ELECTRONICS WORLD (November, 1966, Vol. 76, No. 5). Published monthly by Ziff-Davis Publishing Company at 307 North Michigan Avenue, Chicago, Illinois 60601. (Ziff-Davis also publishes Skiing, Flying, Business & Commercial Aviation, Boating, Car and Driver, Cycle, Popular Photography, HiFi/Stereo Review, Popular Electronics, Modern Bride, Skiing Trade News and Skiing Area News.) One year subscription rate for U.S., U.S. Possessions, and Canada, \$6.00; all other countries, \$7.00. Second Class postage paid at Chicago, Illinois and at additional mailing offices. Authorized as second class mail by the Post Office Department, Ottawa, Canada and for payment of postage in cash.

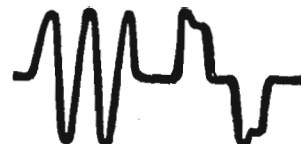

Tips on replacing electrolytic capacitors

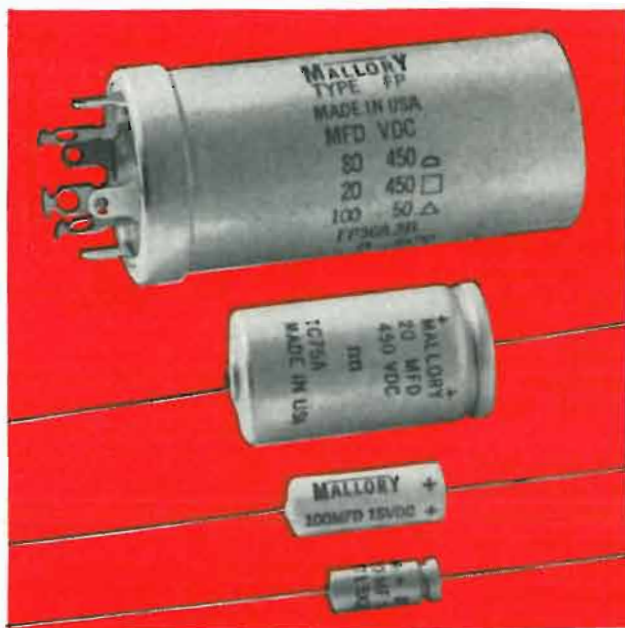

Finding the right electrolytic capacitor for a replacement job often becomes a matter of juggling three factors: what the circuit originally called for, what you can get quickly from a distributor, and what you have on hand in your shop. Here are a few hints that may help to make your life easier.

The important parameters about an electrolytic are voltage rating, capacitance, temperature rating and size. You have a certain amount of leeway on all four of these . . . and knowing how far you can stretch safely may save you a lot of shoe leather looking for the exact replacement.

Let's take voltage first. You can *always* substitute a capacitor with *higher* voltage rating than that originally required, with absolutely no harmful effects (except maybe on your pocket-book, because you may pay for extra capability that you don't need). But you should *never* replace with a voltage rating *lower* than the original.

How about capacitance? Our advice—don't go too far from -10% +50% of the original value. You've probably heard that standard industry specs allow tolerances of 10% low and up to 150% high. Actual manufacturing practice at Mallory, is to make capacitors to considerably tighter tolerances . . . because most radio and TV manufacturers won't tolerate the wider variations. Too small capacitance is apt to raise hum levels. Too high capacitance may lead to surge damage to silicon rectifiers.

On the temperature score, you don't have to worry if you use a Mallory FP-WP, TC, TT, or MTA type, because they're all rated for 85°C (except for three odd-ball TC's), and that's plenty for home instruments or industrial electronics. Our wax-filled cardboard tubulars are rated 65°C. The few cents extra that you might spend for a Mallory capacitor, compared to the cheapest ones you could buy, will assure you of *several* times longer service life.

How about size? Don't be surprised when you find that in many instances the Mallory replacement is *smaller* than the original capacitor (naturally, it will still fit chassis cutouts). That's because of our new techniques for deep-etching aluminum to increase the effective area of the anode. So we can get about nine times more microfarad-volt rating inside a given container than with plain foil.

One final tip. Our new Capacitor Replacement Guide makes it a cinch to find the exact part number to specify, to replace just about any electrolytic you may encounter. Ask your Mallory Distributor for a copy, or write Mallory Distributor Products Company, a division of P. R. Mallory & Co. Inc., P. O. Box 1558, Indianapolis, Indiana 46206.

How much aluminum foil makes 2 mfd at 150 WVDC?

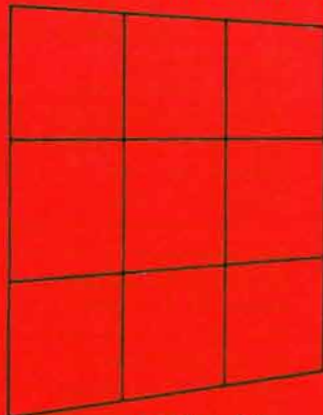

In plain foil, it takes 9 sq. in.

In Mallory deep-etched foil, only 1 sq. in.

**Buy the BEST!
Buy in KIT form!**



MARK® TEN

CAPACITIVE DISCHARGE
IGNITION SYSTEM

ONLY \$29.95 PPD.!

Why settle for less in motor vehicle ignition systems when you can buy the very BEST from Delta, the originators, the leaders in capacitive discharge (SCR) systems. Delta pioneered this electronic marvel. Thousands have installed this remarkable electronic system. Now YOU can purchase at low, LOW cost, and in easy-to-build kit form, the king of them all, the DELTAKIT. Low price due simply to high production levels at no sacrifice in peerless Delta quality.

**Operate Any Motor
Vehicle More Efficiently**

Compare these proven benefits:

- ▲ Up to 20% Increase in Gasoline Mileage
- ▲ Installs in Only 10 Minutes on any Car or Boat
- ▲ Spark Plugs Last 3 to 10 Times Longer
- ▲ Instant Starts in all Weather
- ▲ Dramatic Increase in Acceleration and General Performance
- ▲ Promotes More Complete Combustion

Literature and complete technical information sent by return mail.

BETTER YET — ORDER TODAY!



DELTA PRODUCTS, INC.

P.O. Box 1147EW, Grand Junction, Colo. 81501
Enclosed is \$_____. Ship prepaid.
 Ship C.O.D.

Please send:

- Mark Tens (Assembled) @ \$44.95
- Mark Tens (Delta Kit) @ \$29.95

SPECIFY — Positive Ground Negative Ground 6 or 12 Volt

Car Year _____ Make _____

Name _____

Address _____

City/State _____ Zip _____

DP 6-2

CIRCLE NO. 121 ON READER SERVICE CARD

LETTERS FROM OUR READERS

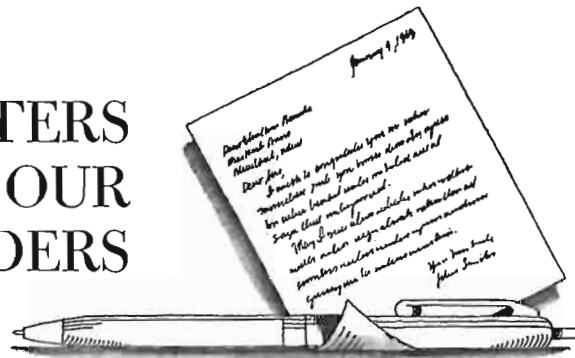

INSULATED-GATE TRANSISTOR

To the Editors:

As the author of some articles and papers on insulated-gate field-effect transistors, I was quite interested to read Donald Lancaster's piece in your July, 1966 issue on the same subject. In general, I felt the topic was well handled. However, there are two items which Don and his readers might find interesting.

The first item is that the IEEE Symbols Coordinating Committee now has an IGFET symbol which gives positive identification of the source terminal by putting the gate connection at the source end of the gate. In addition, this new symbol shows whether an IGFET has a *p*-channel or an *n*-channel and also differentiates between enhancement-type and depletion-type IGFET's.

Incidentally, Don's article may have left his readers with the impression that all IGFET's are the enhancement type. As you probably know, there are several depletion-type IGFET's available also. (Depletion types are characterized as "normally on" in contrast with the enhancement types which are "off" in the absence of gate voltage.)

Another point is that I think Don has confused "bipolar" with "bilateral." All FET's, whether insulated-gate (IGFET) or junction-gate (JUGFET), are unipolar devices because all source-to-drain conduction is carried out by charge carriers of one polarity. On the other hand, all FET's are *bilateral* because their source and drain can be interchanged. (It should be noted that differences in the size or relative position of source and drain in some devices lead to the designation of a "preferred" source which gives best performance in certain applications.)

IGFET's should open a whole new range of applications, so I'm looking forward to reading future articles.

DAVID M. GRISWOLD
New Providence, N. J.

* * *

AUTO BURGLAR ALARM

To the Editors:

After reading the article by Edwin R. DeLoach on an SCR auto burglar alarm (August issue), I thought some readers might be interested in the alarm I de-

signed. It operates on the same principle but can be built for under \$6.

With S1 in the "On" position, RL2 will be energized if the hood, trunk, or dome light switch is operated. With the

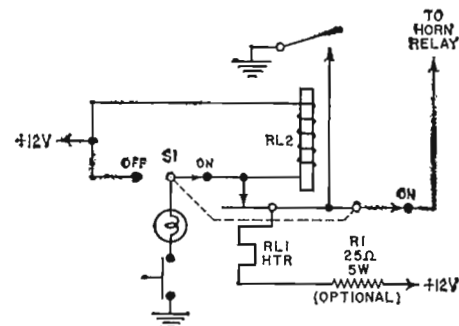

contacts of RL2 closed, the horn will blow and RL2 will remain energized. The horn will continue to blow until the heater of RL1 opens the contact of this circuit, causing RL2 to drop out.

RL1 is used to limit the heater current of RL1, if required. Almost any 12-volt relay will operate with the standard 15-candlepower dome light. Most cars have smaller bulbs in the trunk and under the hood, and these bulbs will have to be changed to 15 candlepower or greater.

DARYL R. STYBLO
Waltham, Mass.

* * *

SAW-TOOTH TESTING

To the Editors:

The article "Saw-Tooth Testing of Audio Amplifiers" in your July issue presents some interesting and useful information, but the authors seem to have drawn some incorrect conclusions.

The symmetrical square wave and the saw-tooth wave each consist of a fundamental frequency and an infinite series of harmonics, the amplitude of the *n*th harmonic being 1/*n* times that of the fundamental. As pointed out in the article, the square wave consists only of odd-order harmonics, while the saw-tooth has both even and odd harmonics. Now, for the same degree of resolution of each waveform, the same number of harmonics is required, and since only odd-order harmonics are present in the square wave, it follows that the bandwidth for the square wave is twice that for the saw-tooth instead

(Continued on page 12)

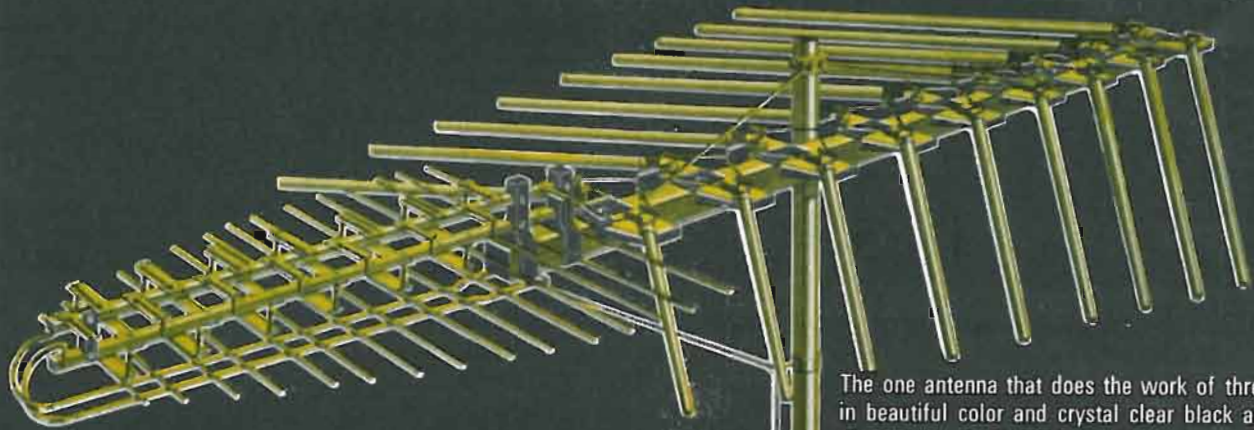

FINCO ALL-BAND UHF-VHF-FM ANTENNA
75 OHM Model CX-UVF-24 \$72.10 List

FINCO ALL-BAND UHF-VHF-FM ANTENNA
300 OHM Model UVF-24 \$59.95 List

The one antenna that does the work of three! Pulls in beautiful color and crystal clear black and white pictures on both UHF and VHF channels...plus the finest stereophonic and monophonic FM sound reproduction.

300-ohm models for normal reception areas from \$18.50 to \$59.95

75-ohm models for poor reception areas from \$42.65 to \$72.10

FINCO

introduces / 75-ohm COLOR VE-LOG ANTENNAS
FOR UHF-VHF-FM RECEPTION

Finco's Swept-Element Antenna challenges all competition. Its unique design assures the finest color and black and white TV reception—plus superb FM and FM Stereo tone quality.

300-ohm models for normal reception areas from \$16.95 to \$54.50

75-ohm models for poor reception areas from \$18.55 to \$62.80

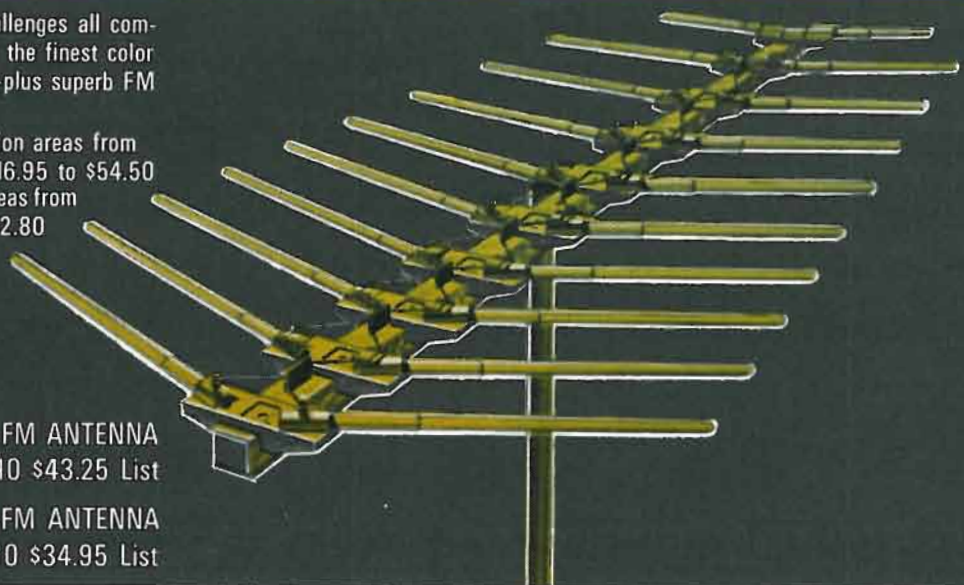

FINCO SWEPT-ELEMENT VHF-FM ANTENNA
75 OHM Model CXVL-10 \$43.25 List

FINCO SWEPT-ELEMENT VHF-FM ANTENNA
300 OHM Model VL-10 \$34.95 List

FREE! ALL FINCO CX-VL, CX-UVF AND UVF ANTENNAS COME WITH A FREE INDOOR SET-MOUNTED TRANSFORMER, VHF-UHF TRANSFORMER SPLITTER OR VHF-UHF SPLITTER.



THE FINNEY COMPANY

34 WEST INTERSTATE STREET, DEPT. 410, BEDFORD, OHIO

Electronics comes alive with NRI Training Kits



DISCOVER THE EASE AND EXCITEMENT OF TRAINING AT HOME THE NRI WAY

New Achievement Kit—Custom Training Kits—"Bite Size" Texts

Only NRI offers you this pioneering method of simplified "3 Dimensional" home-study training in Electronics, TV/Radio and Broadcasting/Communications. It's a remarkable teaching idea unlike anything you have ever encountered, the result of more than half a century of simplifying, organizing and dramatizing learning-at-home techniques. If you are an ambitious man—regardless of your education—you can effectively learn the Electronics field of your choice the NRI way.

NRI has *simplified* Electronics by producing "bite size" lesson texts averaging only 40 pages each. Dozens of illustrations open wide a picture window through which you'll see and understand practical uses of Electronics. You start out with NRI's exclusive Achievement Kit, containing everything you need to get started fast. (Illustrated at right.)

NRI has *organized* Electronics training to take you step-by-step from the first stages into more intriguing areas. Once you know the fundamentals thoroughly, it's easy to grasp more advanced theory and techniques. You move with confidence and enthusiasm into a new adventure filled with the excitement of discovery.

NRI has *dramatized* Electronics through the careful development of special training equipment that is *programmed* into your training systematically . . . beginning with your first group of lessons. Things you read about come alive in your hands as you build, experiment, purposely cause "problems" in circuits—and solve them. You learn to use test equipment, to build radios and TV sets, transmitter, or computer circuits. It's the priceless "third dimension" in NRI training . . . practical experience.



YOU GET MORE FOR YOUR MONEY FROM NRI

Mail postage-free card now for your free NRI catalog. Then, compare. You'll find—as have thousands of others—NRI training can't be beat. Read about the new Achievement Kit sent the day you enroll; about "bite-size," texts and custom designed training equipment. See why NRI gives you more value. Whatever your reason for wanting more knowledge of Electronics, NRI has an instruction plan for you. Choose from major programs in TV/Radio Servicing, Industrial Electronics and Complete Communications. Or select from special courses to meet specific needs. Check the course of interest to you on postage-free card and mail today for free NRI catalog. No salesman will call. NATIONAL RADIO INSTITUTE, Electronics Div., Washington, D.C. 20016.

Available Under NEW GI BILL

If you served since January 31, 1955, or are in service, check GI line in postage-free card.

More than 50 years of leadership
in Electronics Training



Career? Part-Time Earnings? Hobby? Choose From 10 Training Plans

1. TELEVISION-RADIO SERVICING

Complete training from basic fundamentals of electricity to home entertainment equipment. You learn how to fix radios, hi-fi and stereo sets, black-and-white and color TV, PA systems, etc. A profitable field full or part-time.

2. COMPLETE COMMUNICATIONS*

Designed to teach and provide you with actual practice in operation, service and maintenance of AM, FM and TV broadcasting stations. Also covers marine, aviation, mobile radio, facsimile, microwave, radar.

3. INDUSTRIAL-MILITARY ELECTRONICS

From basic principles to computers. A comprehensive training plan that teaches you the fundamentals, then takes you into such modern-day miracles as servos, telemetry, multiplexing, pulse circuitry, data processing, other career-building subjects.

4. FCC LICENSE*

Specifically designed short course to prepare you for your First Class FCC Radio-telephone License examinations. You begin

with a thorough background in fundamental Electronic principles, advance to required subjects covering equipment and procedures.

5. BASIC ELECTRONICS

A concise course to teach modern Electronics terminology and components. A wealth of practical, useful information to help you better understand the field, to give you some technical knowledge. For anyone who wants a basic understanding of Radio-TV Electronics.

6. MATH FOR ELECTRONICS

A brief course for engineers and technicians who need a quick review of the essential mathematics used in industry, in communications, in government jobs. Basic arithmetic review, short-cut formulas, modern digital numbers systems, much, much more.

7. ELECTRONICS FOR AUTOMATION

This course not for beginners. Offered for men with some fundamental knowledge of Electronics who want a better understanding of Automation in current use. Covers process control, ultrasonics, telemetering and remote control, electromechanical measurements, other key subjects.

8. AVIATION COMMUNICATIONS*

This course prepares you to install, maintain, service aircraft communications equipment. Covers direction finders, ranges, markers, Loran, Shoran, radar, landing systems. Earn your First Class FCC License with Radar Endorsement.

9. MOBILE COMMUNICATIONS*

Learn to install and maintain mobile equipment and associated base stations. Covers transmitters and receivers used by police and fire departments, public utilities, construction projects, taxis, etc. Prepares you for a First Class FCC License.

10. MARINE COMMUNICATIONS*

Covers transmitters, direction finders, depth indicators, radar, Sonar, other equipment used on commercial ships and thousands of pleasure boats. Prepares you for your First Class FCC License with Radar Endorsement.

*You must pass your FCC License exam (any Communications course) or NRI refunds in full the tuition you have paid.

With all the field offices we have

you can build a great future just about anywhere.



You don't need a degree to get in on this fine career opportunity in computer technology. You do need a grasp of electronics and electro-mechanical fundamentals which might have been gained through such military training as: weapons control systems, radar, sonar, radio maintenance—and a strong ambition to build a real future.

Here's how we do it at UNIVAC.

For one thing, we'll teach you all about computers. How they work, and why. How to install and maintain them. By the time you're finished with our training program you're a top notch, all round expert, fully equipped to handle any problems you'll encounter. And all the time you're learning you're on the payroll.

Now, when you're ready to show what you can do, we'll assign you to one of our field offices. With the kind of growth you'd expect from UNIVAC, you'll find them everywhere in the nation, and overseas. Covering a full range of assignments. Of course, you come in under our comprehensive benefits program. And with the way we reward technical ability and initiative, a good man can really go far.

Interested candidates are invited to write Manager of Field Administration, UNIVAC, P. O. Box 8100, Philadelphia, Pa.

UNIVAC
DIVISION OF SPERRY RAND CORPORATION

An Equal Opportunity Employer

(Continued from page 6)
of "not as wide" as claimed by the authors.

The discussion of the "obvious utility" of the saw-tooth is erroneous. Since a 1-kHz saw-tooth contains a 1-kHz fundamental and harmonics at 2, 3, 4 . . . n times the fundamental frequency, it cannot be used to check the response at 100 Hz as claimed.

LLOYD CLAYTON
Gulf Breeze, Fla.

The authors of the original article still believe in the usefulness of the saw-tooth wave for amplifier testing. They point out that since this waveform has no gaps in its frequency spectrum (that is, it covers all harmonics) while the square wave has such gaps (since it includes only odd harmonics), one is more likely to detect a deficiency in frequency response using the saw-tooth. This is especially true for amplifiers with quite sharp roll-offs.

On the matter of using a 1-kHz saw-tooth to check frequency down to 100 Hz, this can certainly be done. If an amplifier, for example, cuts off just below 1000 Hz, it is found to have some phase distortion at this and at lower frequencies. The amplifier must be flat to a substantially lower frequency in order to perform properly at the fundamental frequency of the saw-tooth. We have seen cases where a 100-kHz saw-tooth was put into an amplifier whose response was -6 dB at 100 Hz, and the result was definite curvature of the linear portion of the waveform.—Editors

* * *

TIME DOMAIN REFLECTOMETRY

To the Editors:

I would like to obtain two reprints of John Lenk's article "Time Domain Reflectometry" (September, 1966 issue). This is an excellent presentation of a valuable technique that is not treated adequately in our curriculum. I would like to have these copies for a display case in our department.

JOHN B. PEATMAN
Asst. Prof. of Elec. Eng.
Georgia Institute of Technology
Atlanta, Ga.

* * *

BOONTON CAPACITANCE METER

To the Editors:

In your September, 1966 issue you published an excellent description in your "Test Equipment Product Report" of our Model 71A capacitance/inductance meter. Unfortunately, a typographical error crept in which could be misleading to some of your readers. The capacitance range of the Model 71A extends from 0 to 1000 pF, not 1000 μ F as indicated in your article.

NEIL UPTEGROVE
Boonton Electronics Corp.
Parsippany, N.J. ▲



Three reasons why NOW is the time to buy a JOHNSON MESSENGER

Johnson MESSENGER 100

Now with 6 channels, built-in PA and provision for Tone Alert selective calling.

- Full 5-watt input
- Highly sensitive receiver—0.5 μ v
- 6 KHz bandwidth for excellent selectivity
- Dependable all solid-state construction
- Optional AC and portable power supplies



ONLY
\$129⁹⁵*

*Price includes crystals for one channel, push-to-talk microphone and universal mobile mounting bracket.

FCC Type Accepted

Johnson MESSENGER III

Now with 12 channels and a new low price

- Sensitive double conversion receiver
- All solid-state—18 transistors
- Powerful 3-watt audio system
- Multi-stage noise limiter
- Use it base, mobile or portable



ONLY
\$159⁹⁵*

*Price includes crystals for one channel, push-to-talk microphone and universal mobile mounting bracket.

FCC Type Accepted

Johnson MESSENGER 300

Messenger III with a crystal filter added and at no increase in price

- Crystal filter reduces adjacent channel interference
- 12 crystal controlled channels
- Solid state construction
- Built-in 3-watt PA and provision for Tone Alert
- May be used with accessory AC and portable power supplies



ONLY
\$189⁹⁵*

*Price includes crystals for one channel, push-to-talk microphone and universal mobile mounting bracket.

FCC Type Accepted

*Go with the leader...
go with JOHNSON*



E. F. JOHNSON COMPANY

1179 Tenth Ave., S.W., Waseca, Minn. 56093

Please rush details on the famous Johnson line of CB products.

NAME _____

ADDRESS _____

CITY & STATE _____ ZIP _____

CIRCLE NO. 107 ON READER SERVICE CARD

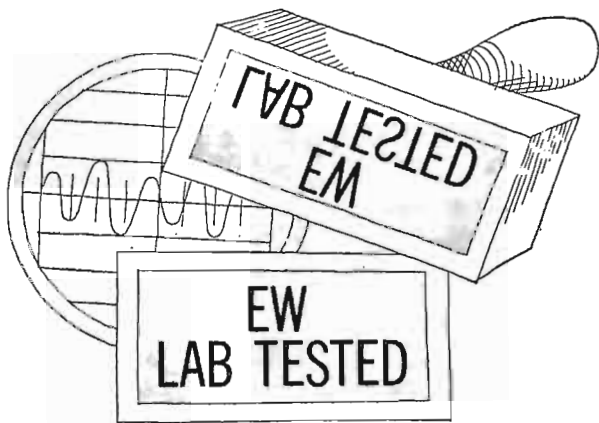

HI-FI PRODUCT REPORT

TESTED BY HIRSCH-HOUCK LABS

Kenwood TK-60 Stereo Receiver
Marantz Model 7T Preamp

Kenwood TK-60 Stereo Receiver

For copy of manufacturer's brochure, circle No. 27 on Reader Service Card.



THE Kenwood TK-60 is a solid-state stereo receiver with a number of unusual features for a unit in its price class. It is relatively large in size, measuring 17 $\frac{3}{4}$ " x 5 $\frac{1}{16}$ " x 14" and weighing some 24 pounds. Virtually all of its circuits are constructed on several printed boards, with the output transistors mounted on large, finned heat-sinks.

The front-end of the TK-60 has a double-tuned r.f. stage for good image rejection; a.f.c. is provided, with a switch to defeat it; and the i.f. section has five stages, followed by a wide-band ratio detector. Unlike most moderately priced receivers, this receiver includes an AM tuner. This is rather simple in its design, with a self-oscillating mixer, two i.f. stages, and a diode detector. A ferrite-rod antenna is built

into the receiver, with provision for an external antenna.

The multiplex demodulator uses a 38-kHz oscillator, synchronized by the 19-kHz pilot carrier. A four-diode balanced demodulator separates the two channels, which are then amplified in individual feedback-type amplifiers. The stereo/mono switching system is quite complex, using six transistors, five diodes, two lamps, and many other components for the logic and switching functions. This is much more elaborate than the switching methods used in most receivers, even those costing considerably more than the TK-60. The complexity is justified by the results, since this is one of the best performing automatic stereo selection systems we have seen.

In the absence of a transmitted pilot

carrier, a red light on the dial face glows, and the multiplex circuits are disabled. When a pilot carrier is received, the red lamp goes out and a blue lamp is turned on, indicating a stereo broadcast. The 38-kHz oscillator is simultaneously gated on and the receiver is in the stereo mode. The outstanding characteristic of this circuit is its freedom from accidental tripping by modulation peaks or interstation noise. Most such circuits give a flickering indication when tuning between stations. The Kenwood will not respond, even momentarily, to anything except a *bona fide* stereo transmission. The switchover is completely silent and undistinguishable except for the different spatial characteristics of stereo.

The audio section of the receiver is rated at 50 watts total music power, with 8-ohm loads. Speakers from 4 to 16 ohms impedance may be driven successfully. There are no transformers in the audio section. The only transformer in the receiver (other than i.f. coils) is the power transformer. The preamplifiers have equalization for RIAA phono and NAB tape head. A mixed (mono) output signal is available in the rear for driving a center-channel speaker through an external power amplifier.

We measured an IHF usable sensitivity of 3.1 μ V on the FM tuner por-

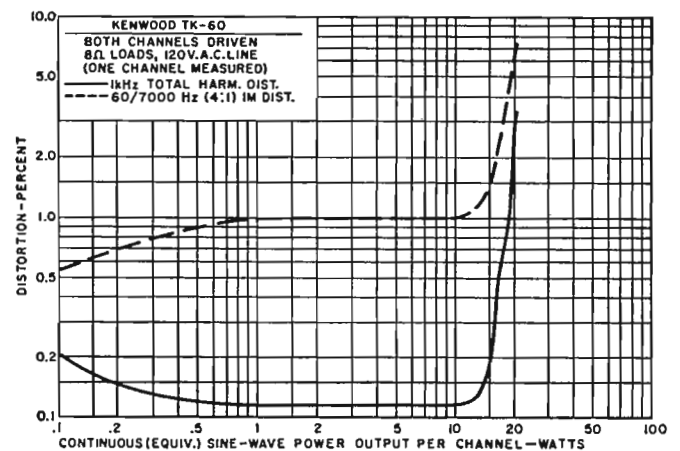
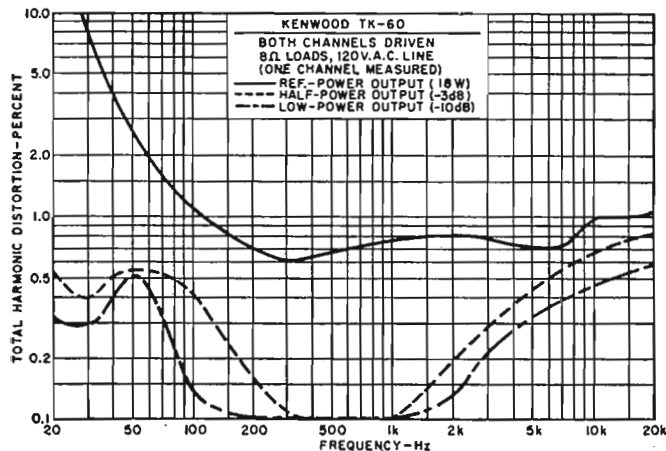

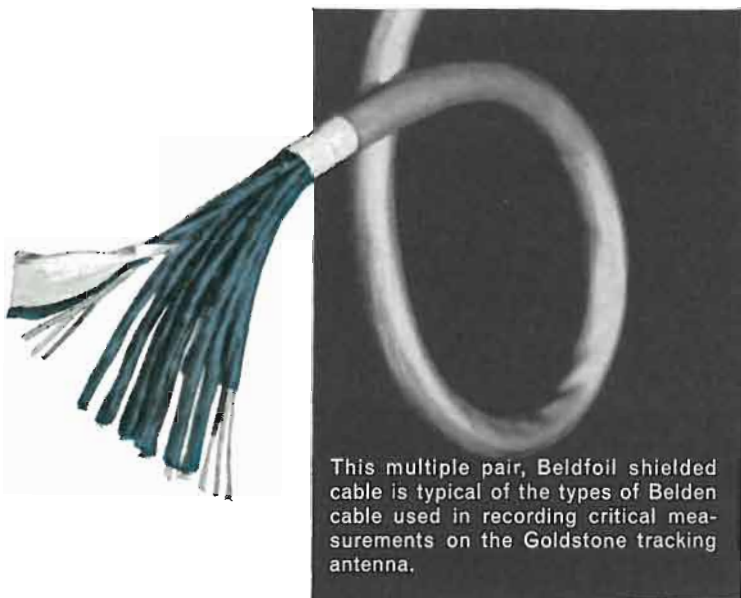

This multiple pair, Beldfoil shielded cable is typical of the types of Belden cable used in recording critical measurements on the Goldstone tracking antenna.

BELDFOIL* SHIELDED CABLE

SOLVED

CRITICAL NASA INSTRUMENTATION PROBLEM!

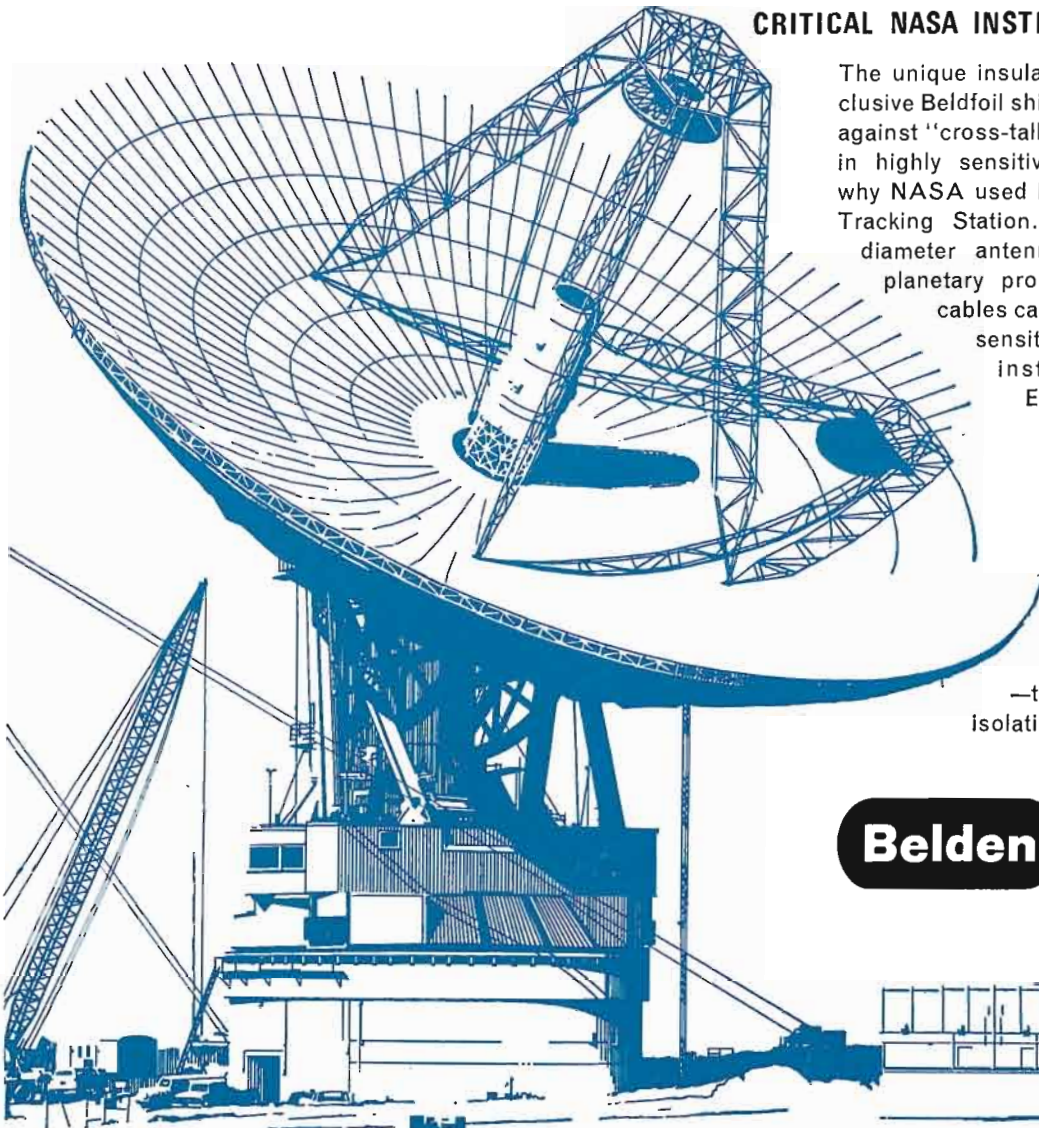

The unique insulating properties of Belden's exclusive Beldfoil shielding provides 100% protection against "cross-talk" and spurious signal impulses in highly sensitive circuit applications. That's why NASA used Beldfoil cable for its Goldstone Tracking Station. ■ In this massive 210 foot diameter antenna, built to track lunar and planetary probes, Belden Beldfoil shielded cables carry instrumentation signals from sensitive structural detectors to an instrumentation facility nearby. Every measurement of critical structure deflection, angular position, structure temperatures, and bearing pressures are recorded and analyzed prior to tracking operations. ■ Get the same precision analyzation in your critical instrumentation. Specify Belden Beldfoil shielded cable —the only cable providing 100% isolation.

*Belden Trademark Reg. U.S. Pat. Off.



FOR COMPLETE INFORMATION
CONTACT YOUR BELDEN
DISTRIBUTOR.

BELDEN MANUFACTURING COMPANY • P.O. Box 5070A • Chicago, Illinois 60680
CIRCLE NO. 200 ON READER SERVICE CARD

Thinking of college
and a
space age career in
electronics?

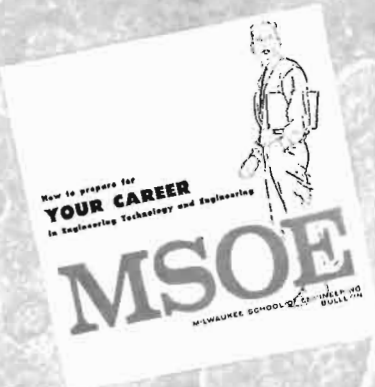

Send for this booklet on
**ENGINEERING TECHNOLOGY
AND ENGINEERING**

Learn how you can prepare for a dynamic career as an electrical or mechanical engineering technician or engineer in such exciting, growing fields as avionics, missiles, reliability control, fluid mechanics, data processing, metallurgy, microelectronics, and advanced aerospace research.

MSOE offers residence study programs leading to these degrees in engineering technology and engineering:

2 years—Associate in Applied Science
4 years—Bachelor of Science

Also get facts about scholarships and financial aids, job placement and other student services, plus photographs of MSOE technical laboratories and student activities. For your copy, just mail the coupon -- no obligation.

Programs approved for veteran training.

MSOE

Milwaukee School of Engineering
Dept. EW-1166, 1025 N. Milwaukee St.,
Milwaukee, Wisconsin 53201

Please send the "Your Career" booklet.
I'm interested in
 Electrical fields Mechanical fields

Name.....Age.....

Address.....

City.....State.....ZIP.....

CIRCLE NO. 102 ON READER SERVICE CARD
16

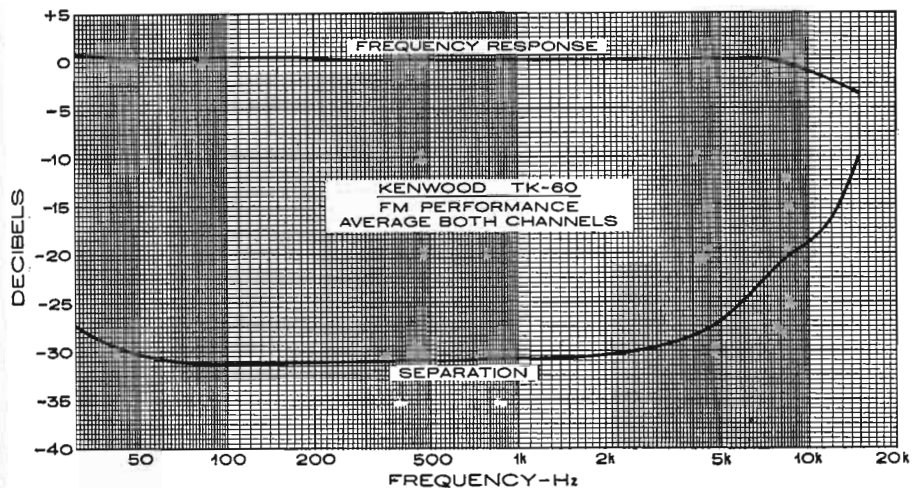

tion. This is very good performance for a moderately priced receiver. The FM frequency response was almost perfectly flat from 30 to 7000 Hz, sloping off slightly to -3.5 dB at 15,000 Hz. The stereo separation was also good, about 30 dB from 30 to 4000 Hz, dropping to 10 dB at 15,000 Hz. The sub-carrier filter, which reduced noise in reception of weak stereo stations, greatly reduced channel separation, yet retained a noticeable stereo effect.

We found the TK-60 easy to tune, and the unambiguous stereo indication system worked perfectly. Even when scanning rapidly across the FM band, the blue stereo light operated for every stereo station, no matter how weak. The a.f.c., although effective, is not needed since we found no drift.

The audio frequency response was within ± 1 dB from 100 to 18,000 Hz, and down 5 dB at 20 Hz. Both the RIAA and NAB equalization were within ± 1.5 dB from below 100 Hz to 15,000 Hz, with the RIAA response following the slight low-frequency roll-off in the audio amplifiers.

With the rated 18 watts per channel (continuous) delivered from both channels simultaneously, the harmonic distortion was less than 1% from 120 to 20,000 Hz, increasing at lower frequencies. At half power (9 watts per channel) or less, the distortion was well under 1% from 20 to 20,000 Hz. At middle frequencies it was under 0.1% at normal listening levels.

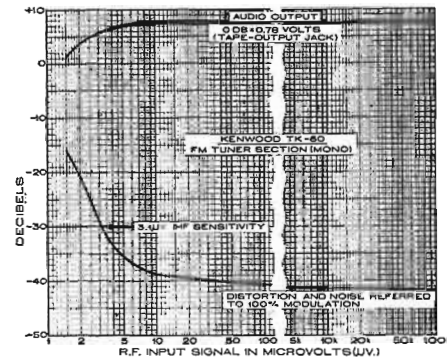

The 1000-Hz harmonic distortion was under 0.2% from 0.1 watt to 15 watts output, increasing to 2% at 19 watts. IM distortion was about 1% up to 10 watts, and was 2% at 16 watts. These measurements were made with both channels driven, 8-ohm loads, and a 120-volt line.

In use tests, the receiver proved to be thoroughly satisfactory. It was sensitive, non-critical to tune, had excellent audio quality, and no flaws appeared in its performance. In this day of very compact components, the large size of the TK-60 seems a trifle strange, but, perhaps because of this, it runs very cool and can be installed in a very limited space without provision for special ventilation.

The Kenwood TK-60 is priced at \$239.95. It offers a combination of style and performance which would be hard to match elsewhere at anything like its price. ▲

Marantz Model 7T Preamplifier

For copy of the manufacturer's brochure, circle No. 28 on Reader Service Card.

THE Marantz Model 7T transistor stereo preamplifier is difficult to criticize since it apparently has no faults. We have encountered other units which incorporate many of the features, but we have never found a unit which embodied *all* of the performance characteristics of the Model 7T. This sort of near-perfection does, of course, have its price.

Most of its frequency response curves can be drawn with a straightedge. The only distortions we were able to measure at any reasonable signal level were those inherent in our test equipment. Using the preamp in a music system for a prolonged test did not reveal a single flaw or basis for criticism.

(Continued on page 95)

A New Electronics Slide Rule with Self-Training Course

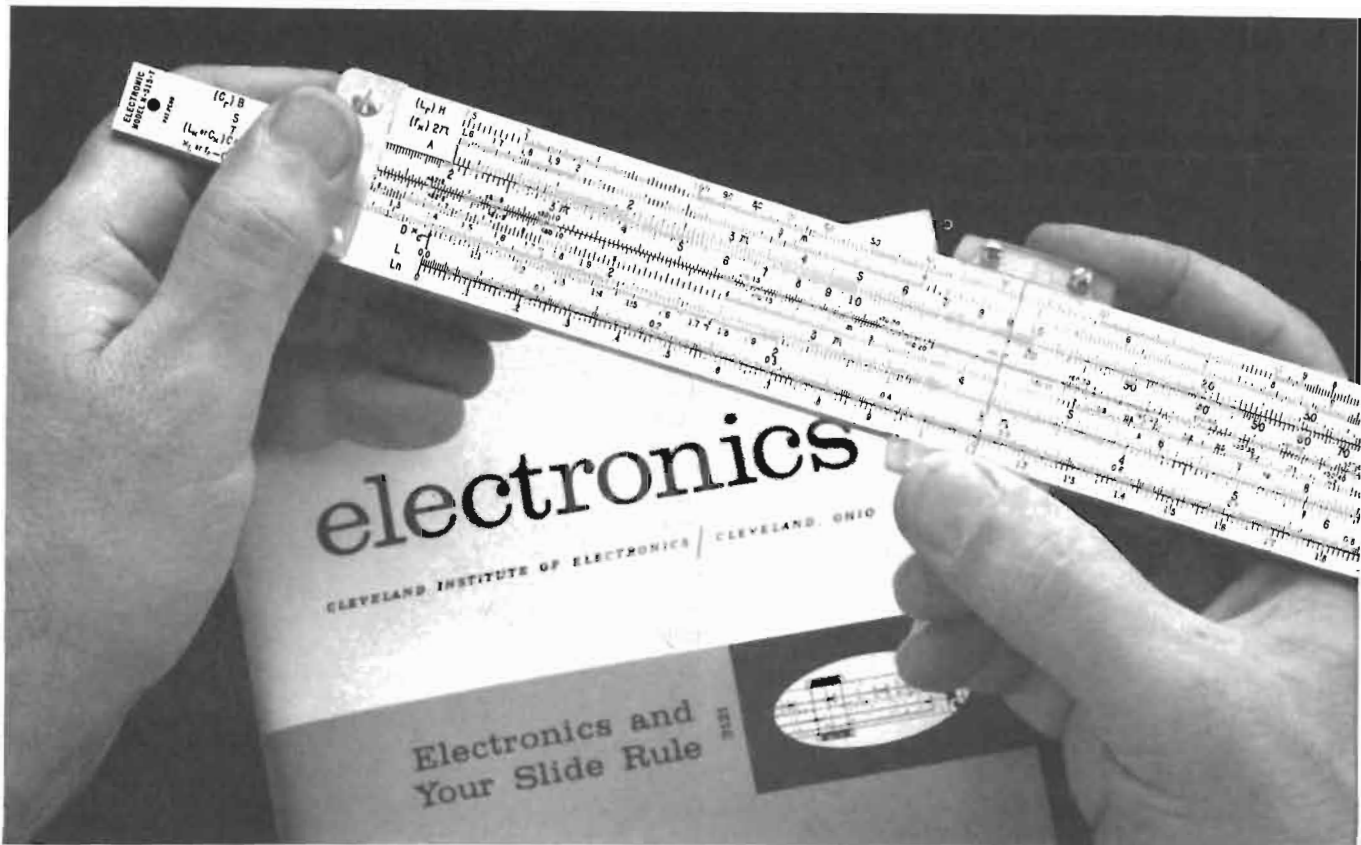

Why didn't someone think of this before?

Here's a great *new* way to solve electronic problems accurately . . . easily. The Cleveland Institute Electronics Slide Rule* is the only rule designed specifically for the exacting requirements of electronics computation. It comes complete with an illustrated Instruction Course consisting of four AUTO-PROGRAMMED* lessons . . . each with a short quiz you can send in for grading and consultation by CIE's expert instructors. With this personal guidance, you'll soon be solving complex electronics problems in seconds while others still struggle along with pad and pencil.

Here's what Mr. Joseph J. DeFrance, Head of the Electrical Technology Dept., New York City Community College, has to say about it:

"I was very intrigued by the 'quickie' electronics problem solutions. It is an ingenious technique. The special scales should be of decided value to any technician, engineer, or student. The CIE slide rule is a natural."

See for yourself. Learn how to whip through all kinds of reactance, resonance, inductance, AC and DC circuitry problems in seconds . . . become a whiz at conventional computations too!

This all-metal 10" rule is made to our tough specs by Pickett, Inc. . . . comes complete with top grain leather carrying case and Instruction Course. A \$50 value for less than \$25. Send coupon for FREE illustrated booklet *and* FREE Pocket Electronics Data Guide. Cleveland Institute of Electronics, 1776 E. 17th St., Dept. EW-130, Cleveland, Ohio 44114.

*TRADEMARK

GET BOTH FREE!

ELECTRONICS SLIDE RULE

Send coupon today →

Cleveland Institute of Electronics

1776 E. 17th St., Dept. EW-130 • Cleveland, Ohio 44114

Please send FREE Electronics Slide Rule Booklet.
SPECIAL BONUS: Mail coupon promptly . . . get FREE Pocket Electronics Data Guide too!

Name _____ (Please Print)
Address _____ County _____
City _____ State _____ Zip _____

A leader in Electronics Training . . . since 1934

CIRCLE NO. 123 ON READER SERVICE CARD

**“Get more
education
or
*get out of
electronics***

...that's my advice.”

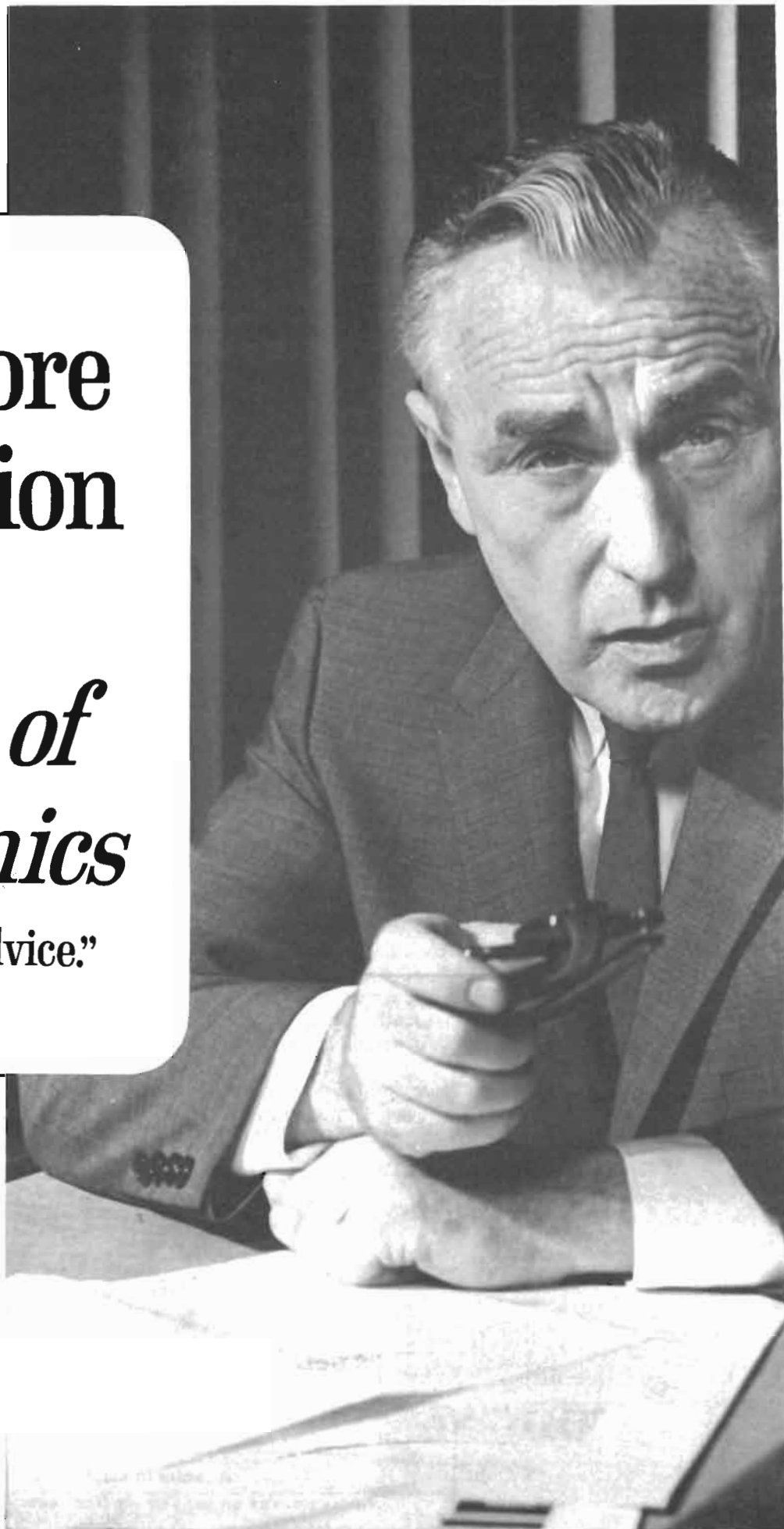



NOW! 2 NEW PROGRAMS!
 ● Industrial Electronics for Automation
 ● Computer Systems Technology

Ask any man who really knows the electronics industry. Opportunities are few for men without advanced technical education. If you stay on that level, you'll never make much money. And you'll be among the first to go in a layoff.

But, if you supplement your experience with more education in electronics, you can become a specialist. You'll enjoy good income and excellent security. You won't have to worry about automation or advances in technology putting you out of a job.

How can you get the additional education you must have to protect your future—and the future of those who depend on you? Going back to school isn't easy for a man with a job and family obligations.

CREI Home Study Programs offer you a practical way to get more education without going back to school. You study at home, at your own pace, on your own schedule. And you study with the assurance that what you learn can be applied on the job immediately to make you worth more money to your employer.

You're eligible for a CREI Program if you work in electronics and have a high school education. Our FREE book gives complete information. Airmail postpaid card for your copy. If card is detached, use coupon below or write: CREI, Dept. 1121-D, 3224 Sixteenth Street, N.W., Washington, D.C. 20010.



The Capitol Radio Engineering Institute
 Dept. 1121-D, 3224 Sixteenth Street, N.W., Washington, D.C. 20010

Please send me FREE book describing CREI Programs. I am employed in electronics and have a high school education.

NAME _____ AGE _____

ADDRESS _____

CITY _____ STATE _____ ZIP CODE _____

EMPLOYED BY _____

TYPE OF PRESENT WORK _____ GI BILL

I am interested in Electronic Engineering Technology,
 Space Electronics Nuclear Engineering Technology
 NEW! Industrial Electronics for Automation
 NEW! Computer Systems Technology

Get this \$65 RCA color TV course FREE



when
you buy
this



WR-64B RCA Color
Bar/DoV/Crosshatch Generator

or this



WR-69A RCA TV-FM
Sweep Generator

or this



WR-99A RCA Marker Generator

or this



WO-91B RCA 5" Scope

That's right! RCA Institutes famous Home Study Color TV Servicing Course FREE, when you buy ANY ONE of the instruments shown here. Buy all four...get four courses. Enroll all your technicians while you equip your shop with the instruments you'll need for color TV servicing anyway.

Here's how it works: Simply buy one, or all, of the four instruments shown, the WR-64B, WR-69A, WR-99A, or WO-91B—ALL essential color TV test instruments—from your Authorized RCA Test Equipment Distributor between now and November 15, 1966. Fill out your warranty registration card and attach the white identification label on the carton. Send them to RCA, Test Equipment Headquarters, Bldg. 17-2, Harrison, New Jersey. We will send you the enrollment form and a binder

containing the first two lessons. When you complete the lessons and forward them to RCA Institutes for grading, the next lessons will be supplied to you directly from RCA Institutes, all without charge to you.

But do it now. This offer is good only for equipment purchased between September 1, and November 15, 1966. To allow for postal delay, we will honor cards received up until December 1, 1966. Here's your chance to equip your shop for color servicing while we train your people for FREE!



Electronic Components and Devices, Harrison, N.J.

The Most Trusted Name in Electronics

Linear Integrated Circuits

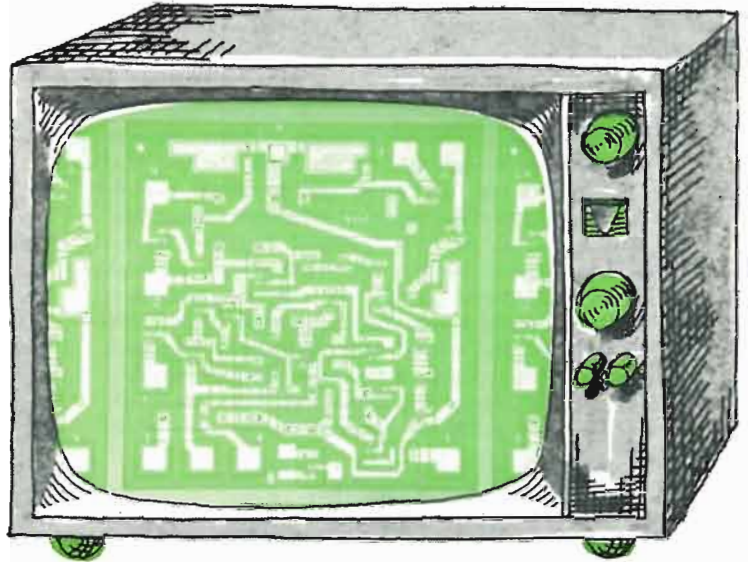

By B.V. VONDERSCHMITT and R.L. SANQUINI

RCA Electronic Components & Devices

The circuit engineer who is designing consumer products must now change his way of thinking in order to include the use of integrated circuits. Here are some practical ground rules to follow in the design of such equipment.

DURING the initial stages of integrated-circuit development, most of the effort was directed toward the design of digital circuits. Within the past three years, however, both equipment-design engineers and integrated-circuit applications engineers have been working diligently to design circuits for linear applications. One of the major difficulties has been the development of linear circuits which are economical in equipment use yet sufficiently flexible in application to permit their employment in many different types of equipment in which the actual functions may differ greatly. Because the development cost of a circuit from inception to successful production is substantial (primarily in engineering manpower), a sufficient production quantity to amortize development cost is required.

A rather wide variety of linear circuits are currently available as "off-the-shelf" items. Although many of these circuits were designed and developed for specific applications, there is also an impressive list of linear circuits with a broad base of application. (For further details, refer to the article "Linear Integrated Circuits: What's Available?" in this issue.—Editors)

The use of linear integrated circuits in equipment has lagged digital use by approximately three years. Fig. 1 shows a projection of linear-circuit applications from 1965 through 1970. To a large extent, the rate of growth will be a sharp function of the acceptance of linear integrated circuits in the consumer market because the design time from inception to full production is at least twice as long for militarized as for consumer equipment.

There has been much speculation about the future of the circuit or equipment-design engineer and his role in integrated-circuit evolution. In the digital field, there is little doubt that the circuit engineer's role will be changed rather dramatically over the next decade. He will almost certainly be working with "off-the-shelf" gates (flip-flops) which already exist as standard items in combinations of low power and low switching speed to higher power and ultra-high switching speeds. The low cost of these standard items will tend to force equipment manufacturers to use existing types rather than design their own and incur the expense of developing and "debugging" new circuits for which they cannot demand sufficient volume to provide low cost. Large-scale integrated arrays will further change the role of the digital-circuit engineer.

In the linear field, however, the future is not so clear. Because communications equipment (commercial or military) demands a wide variety of circuits, there tends to be a conflict between the most economical design, *i.e.*, more functions within one package intended for a specific application, and the simpler single-function design which can be used in a large number of different applications.

To fulfill his new role in the integrated-circuit field, the circuit engineer must become familiar with the "ground rules" that are used to design circuits suitable for integration. Many of the ground rules are dictated by cost considerations. To design circuits, however, the engineer must be familiar with the list of basic components, their characteristics and the variation of these characteristics within the nor-

mal production processes, and the trade-offs of closer tolerances on characteristics and the reduction in yield that these tolerances will cause.

For the design of completely monolithic circuits with present processing capability, there are four components available to the linear-circuit designer: transistors, diodes, resistors, and capacitors. Figs. 2 through 6 show the equivalent circuits of these four components in monolithic form and their characteristics. The wide range in basic parameters and in parasitic components results from the fact that transistor geometries can be varied and processes can be changed to effect large differences in transistor characteristics in the same circuit. In an operational amplifier, for example, the input transistors may be required to have high *beta* at collector currents as low as 100 microamperes, while the output transistor may be required to deliver 100 milliamperes. When the circuit and equipment engineers understand the characteristics of the basic devices, application of integrated circuits in equipment functions effectively reduces to the same problems encountered in the use of discrete components.

Cost and Reliability

The factors that contribute to the cost of electronic equipment can be categorized as follows:

1. Original component cost.
2. Inspection of components at the equipment manufacturer's plant to guarantee conformance with the purchase specifications.
3. Labor associated with assembly of components into final equipment.
4. Troubleshooting of equipment at the manufacturer's plant as a result of defects in the original component or defects caused by the equipment manufacturing process.
5. Maintenance of the equipment over its useful life.

The relative importance of these five factors is largely a function of the type of end equipment—military, industrial, or consumer. For the military market, item 1 can be more significant than the other four. For consumer applications, items 1, 2, and 3 are the most significant, with item 1 most important of all.

There are other significant factors in the use of integrated circuits in consumer-type equipment which are difficult to

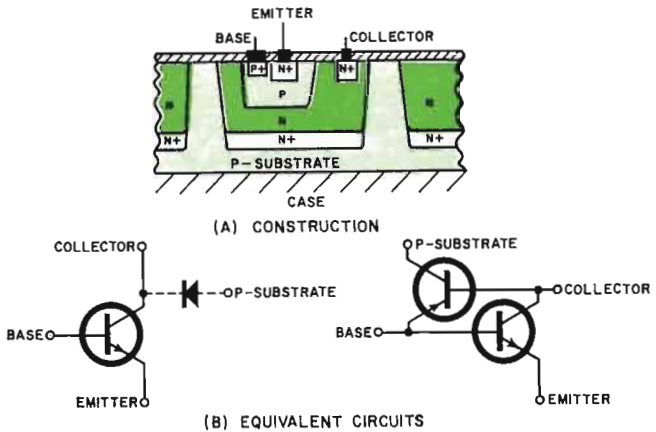

CHARACTERISTICS

$V_{C10} = 30-75 \text{ V}$	$I_{C10} = 1 \text{ pA}-100 \text{ }\mu\text{A}$	$\beta = 20-200$
$V_{CE0} = 15-35 \text{ V}$	$I_{CE0} = 1 \text{ pA}-100 \text{ }\mu\text{A}$	$f_T = 300-1000 \text{ MHz}$
$V_{CB0} = 30-75 \text{ V}$	$I_{CB0} = 1 \text{ pA}-100 \text{ }\mu\text{A}$	$V_{CE(sat)} = 0.15-0.5 \text{ V}$
		@ 10/1 mA
$V_{EB0} = 3-6 \text{ V}$	$I_{EB0} = 1 \text{ pA}-100 \text{ }\mu\text{A}$	
$C_{C1} = 1-4 \text{ pF}$	$I_Q = 100 \text{ }\mu\text{A}-200 \text{ mA}$	$V_{BE} = 0.75 \text{ V @ } 10/1 \text{ mA}$
$C_C = 0.5-1.5 \text{ pF}$		

Fig. 2. Silicon monolithic integrated-circuit transistors.

cost-analyze, *e.g.*, the availability of replacement parts in case of an integrated-circuit failure. Unless some standardization can be achieved by a manufacturer on successive models, availability of replacement parts may be an added factor in servicing problems.

Experience to date indicates that integrated circuits improve equipment reliability by a factor which is almost directly related to the number and complexity of components within one package. Failures tend to occur as a result of servicing of other parts of the equipment, rather than through any fundamental failure of the integrated circuit itself. Various integrated-circuit manufacturers have demonstrated failure rates from 0.03% to 0.001% per 1000 hours with acceleration factors normalized to 55°C operation. If an MTBF (mean time between failures) of ten million hours is considered as typical, a complexity of 100 circuits results in a theoretical equipment MTBF of more than ten years. This value is already nearly at the limit of equipment obsolescence.

Manufacturers of consumer equipment will not use integrated circuits unless the initial cost is no more than that of an equivalent complement of discrete components. A small percentage of the initial cost may be added because of the elimination of the additional handling required for discrete-component circuits. Reliability improvement, although very real, is of significance primarily to military-equipment manufacturers. There are exceptions in the industrial field, however; users of test equipment (counters, oscilloscopes, digital voltmeters, and the like) are sensitive to the cost of maintenance and the cost of down-time of test equipment both in engineering and production use.

Another important factor is that special circuits designed for a specific application may be used only when a sufficient volume is needed to justify the engineering costs required to design, develop, and "debug" the circuit, to introduce it into production, and to refine it in production until the circuit can be manufactured with an acceptable yield. The cost of such development (which is primarily engineering manpower cost rather than the cost of the masks associated with the circuit) is between \$10,000 and \$50,000, depending upon the complexity of the unit. It becomes obvious, therefore, that selection of standard "off-the-shelf" units is preferred wherever possible.

The most important factor affecting the cost of integrated circuits as compared with that of discrete components is inherent in the manufacturing process. This basic consideration is that every discrete component must have an individual package and must receive individual handling

Fig. 1. Projected use of linear IC's from 1965 through 1970.

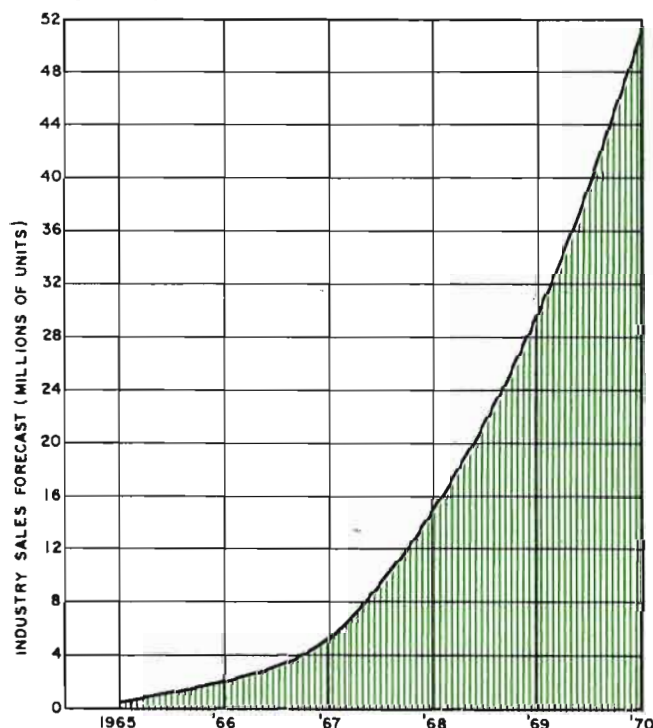

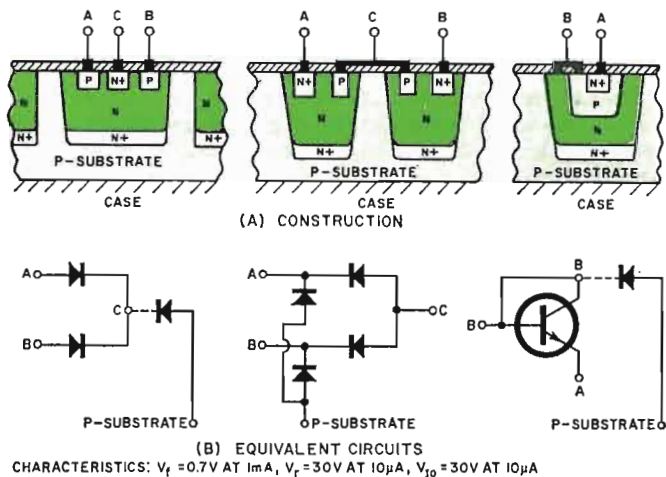

Fig. 3. Silicon monolithic integrated-circuit diodes.

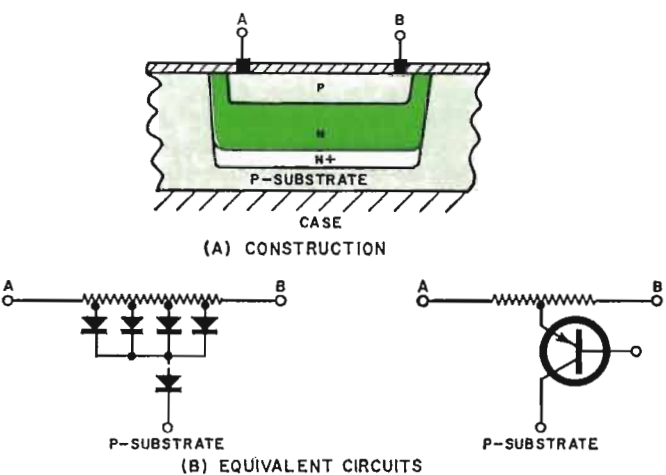

Fig. 4. Construction and equivalent circuit of IC resistor

after dicing (breaking into individual pellets) through the final test. Practical methods of handling the pellet dictate a minimum pellet dimension of 0.015 to 0.020 inch. However, only a very small percentage of this silicon area is utilized. Improved methods of attaching the pellet to the package (e.g., the flip-chip method which eliminates mounting and bonding) plus the use of either epoxy or silicone encapsulation for the package all tend to reduce the cost per die to a uniform figure. As a result, the increased number of functions per package possible with monolithic integrated circuits and the utilization of a higher percentage of the silicon are fundamental considerations which assure that integrated circuits offer distinct cost advantages. This advantage will become sharper as processing technology (line resolution) improves to permit further reduction of the silicon area.

Packages

The following items must be considered in the selection of the package to be used for integrated circuits: (1) cost, (2) difficulty of assembly on printed-circuit boards, (3) ability to isolate between input and output in a high-gain circuit, and (4) shielding to prevent radiation, particularly in high-frequency applications.

The lowest cost package available at the present time is the TO-5, 8-lead package shown in Fig. 7. This package has the advantages of low cost, shielding, assured hermeticity, and sufficient spacing between leads to permit assembly on printed boards by means of wave-soldering techniques.

When an integrated circuit requires more than eight leads, 10- or 12-lead TO-5 packages can be used. The leads of these packages can be reformed to provide wider spacing.

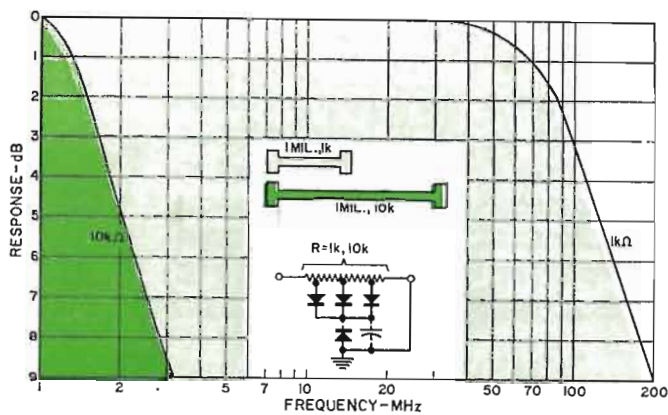

Fig. 5. Frequency characteristics of pair of IC resistors.

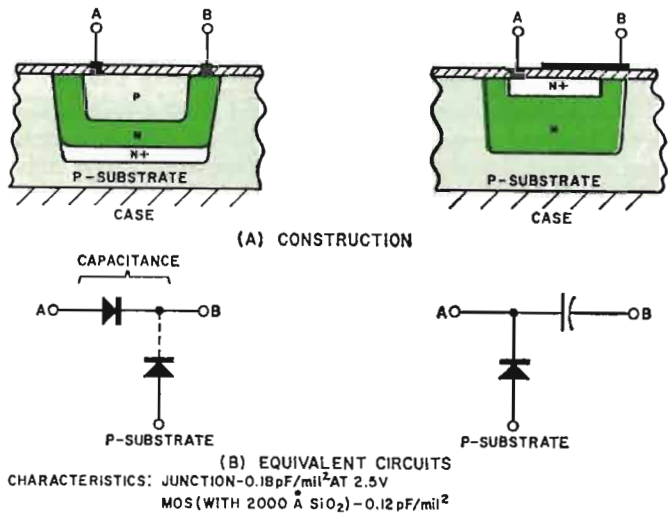

Fig. 6. Equivalent circuits, characteristics of IC capacitors.

Fig. 8 shows a 14-lead flat package that offers the advantages of greater compactness and improved flexibility in circuit connections. The disadvantages of this type of package are that it is in most cases more expensive than the TO-5 case and in all instances requires lead reforming if soldering techniques are to be used.

Several manufacturers are introducing dual in-line packages which permit large separation between the input and output leads. Fig. 9 shows a typical dual in-line package. Some of these packages are hermetically sealed and some are surface-passivated and mechanically protected by means of transfer molding with either an epoxy or silicone. These packages, particularly those of the transfer-molded types, promise to be quite low in cost.

Monolithic Circuits vs Other Types

Development work on microcircuits has covered not only the monolithic circuits which now appear to be receiving universal acceptance but also thin-film, thick-film, and "hybrid" or "chip" circuits. The following definitions may be used to differentiate among these various types of microcircuits.

Fig. 7. The type TO-5, 8-lead package and its dimensions.

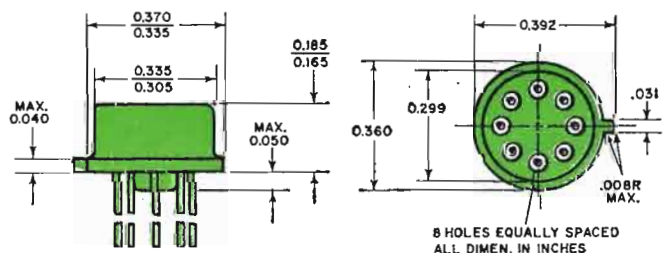

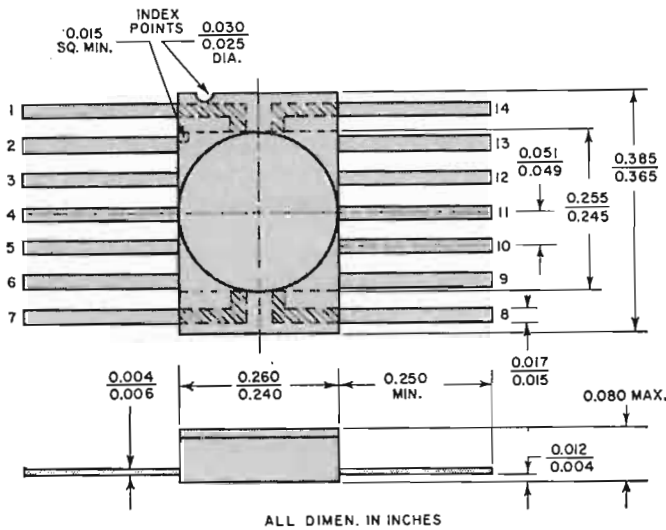

Fig. 8. The 14-lead flat package, along with its dimensions.

In *monolithic* circuits, the active and passive components are fabricated simultaneously by selective diffusion. Isolation between circuit elements is obtained by a single diffusion step which forms back-to-back diodes, conductively isolating these elements.

In *thin-film* circuits, the passive elements are generated by masking and successive evaporation of various materials to permit optimization of the characteristics of these materials. The objective of all thin-film processes is to fabricate active as well as passive devices by evaporation. To date, the evaporation of well-performing active devices has seriously delayed acceptance of this approach. In *thick-film* circuits, passive components are deposited in the form of thicker films through a masking technique.

"*Hybrid*" circuits cover the use of thin-film passive devices, thick-film passive devices and interconnections, monolithic chips, and single special-characteristic active devices which are electrically isolated by a low-dielectric-constant material and which are interconnected by internal bonding techniques, either thermal-compression or ultrasonic.

The advantages and disadvantages of the three types of circuits are summarized in Table 1. From the standpoint of an equipment manufacturer, the most significant considerations for selection of a microcircuit are the availability of multiple sources and low cost. Improvements in processing, stemming primarily from the decrease in size of the various components in monolithic circuits, have reduced and

Fig. 9. A 1/4-in by 3/4-in dual in-line package for IC use.

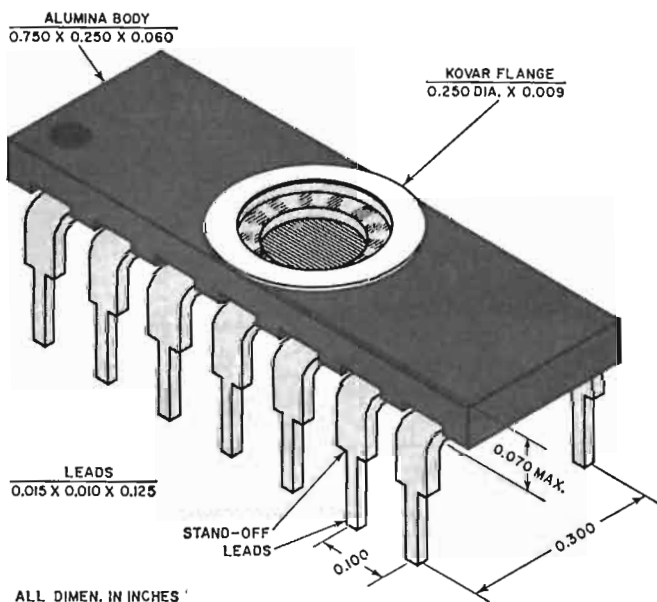

will continue to reduce parasitic elements to the extent that they can be considered relatively insignificant in the design of circuits through the v.h.f. range.

Monolithic linear circuits designed to date have been mainly bipolar circuits, and this type will continue to represent a major portion of the circuits available in the near future. The same advantages (less cross-modulation, high input impedance for audio and operational-amplifier operations, and lower noise at low frequency) that result from the use of MOS and junction-type field-effect transistors in discrete circuits can be expected in integrated circuits. For the near future, however, MOS integrated circuits will be primarily large-scale digital arrays. After reliability is established with these arrays and processes are refined, more linear MOS circuits will be introduced.

Criteria for Selection

In designing with integrated circuits, an equipment-design engineer should, if possible, select standard circuits and use outboarded components for his specific applications. The partial list of available standard circuits will grow substantially over the next three years so that most signal-processing functions can be accomplished by the use of standard circuits plus a limited number of discrete components. Because of the advantages of multiple sources, such standard circuits will be selected in most instances.

For minimum cost, which can normally be provided by multi-function circuits, it may prove economical to design special circuits if the manufacturer's volume is sufficient to justify the expense. The following steps are necessary to develop new designs:

1. Define the input, output, and transfer characteristics of the circuit to be developed.

2. Estimate the cost of the discrete components that the new circuit will replace. After the circuit is designed, the production cost can be estimated rather accurately from a determination of the silicon area required, provided the specifications and design are consistent with normal processing variations.

3. In development of the circuit, keep in mind the following fundamental ground rules:

- (a) Select the components based on minimum wafer area; cost and yield are related to the pellet size.

- (b) Design the circuit to tolerate a large variation in absolute resistor values. Variations in absolute values of $\pm 25\%$ provide lowest cost. Yields for absolute values of $\pm 10\%$ would be low, and hence cost would be high. Ratios between two resistors can be held to $\pm 2\%$. Permissible variations designed to allow larger tolerances are desirable.

- (c) Minimize the use of large capacitor values. Values in excess of 50 picofarads are considered undesirable.

- (d) Design circuits to tolerate a large range of transistor β .

- (e) Take advantage of the matching of transistors for β and V_{BE} ; these matching characteristics are fundamental in the production of integrated circuits as a result of the close proximity of components and the simultaneous fabrication of these components.

- (f) Wherever possible, (Continued on page 79)

Table 1. Advantages and disadvantages of various types of IC's.

	Advantages	Disadvantages
Monolithic	Low cost, improved reliability, multi-sources.	Passive components characteristics cannot be optimized. Limited to small capacitors (50 pF), no inductive components.
Thin Film	Passive components can be optimized.	High cost, active devices must be attached separately. Multi-source manufacturers difficult to obtain.
Hybrid	Both active and passive devices can be optimized.	High cost, poor reliability.

Line-Operated Transistor TV Sets: Magnavox

By WALTER H. BUCHSBAUM

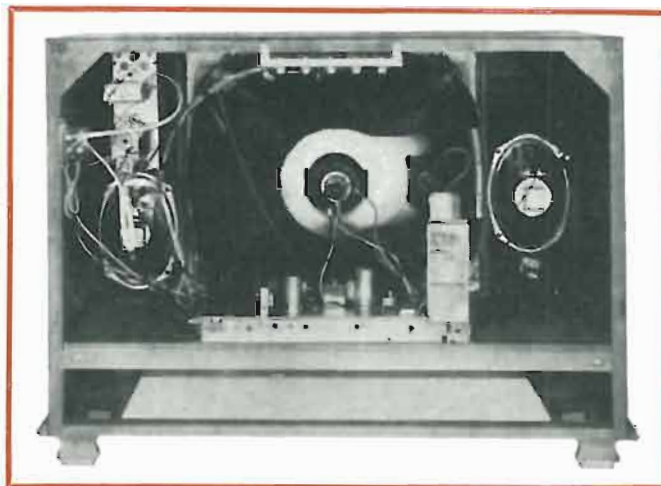

Fig. 1. The Magnavox T908 chassis can drive a 24-inch CRT.

A light-dependent resistor that compensates for ambient room lighting, a novel horizontal oscillator circuit, and capability of driving up to 27-inch CRT's are featured in these receivers.

THE Magnavox Co. is the first TV manufacturer to offer a completely transistorized (except for the CRT and high-voltage rectifier) 27-inch TV receiver. The same basic chassis is used in the Magnavox "Astrosonic" line, which includes 19-inch portables and 23- to 27-inch console models. Shown in Fig. 1 is the 24-inch model with the rear cover removed. It is startling, at first, to see a large picture tube and two substantial speakers mounted in a console with a relatively small chassis and no visible vacuum tubes. The main advantages such a receiver has over its vacuum-tube cousin are the use of considerably less power and less heat, and greater reliability.

These transistor sets operate from the 120-volt line. The high-voltage winding of the power transformer and its rectifiers provide +68 to +140 volts, while the low-voltage section provides +14 volts unregulated and +12 volts regulated by a single zener diode.

The receiver uses a total of 22 transistors, four of which are used in the v.h.f. and u.h.f. tuner, and 23 diodes. The single vacuum tube, in addition to the picture tube, is a 1K3

high-voltage rectifier for powering the CRT ultor anode.

Generally speaking, the transistor circuits are very much like those described for previous transistor TV receivers. Both v.h.f. and u.h.f. tuners, the three-stage i.f. section, and the two-stage video amplifier are relatively conventional. The first video amplifier is an emitter-follower which drives the output stage. To get sufficient video-signal amplitude, this stage is connected to the +140-volt supply. Like most transistor receivers, a two-stage a.g.c. section controls the gain of the v.h.f. tuner r.f. stage separately. The i.f. gain is controlled by applying the a.g.c. voltage to the base of the second i.f. stage, and from the emitter of this transistor to the base of the first i.f. amplifier. This is the generally accepted forward-a.g.c. method.

The intercarrier audio circuit uses a single sound i.f. stage, a dual-diode ratio detector, and two direct-coupled stages of audio amplification. The audio output stage receives its collector voltage from +110 volts. Since some of the console models include transistorized hi-fi equipment, the audio output circuits will vary (*Continued on page 98*)

Fig. 2. A light-dependent resistor senses the ambient room lighting and makes corrections in both contrast and brightness.

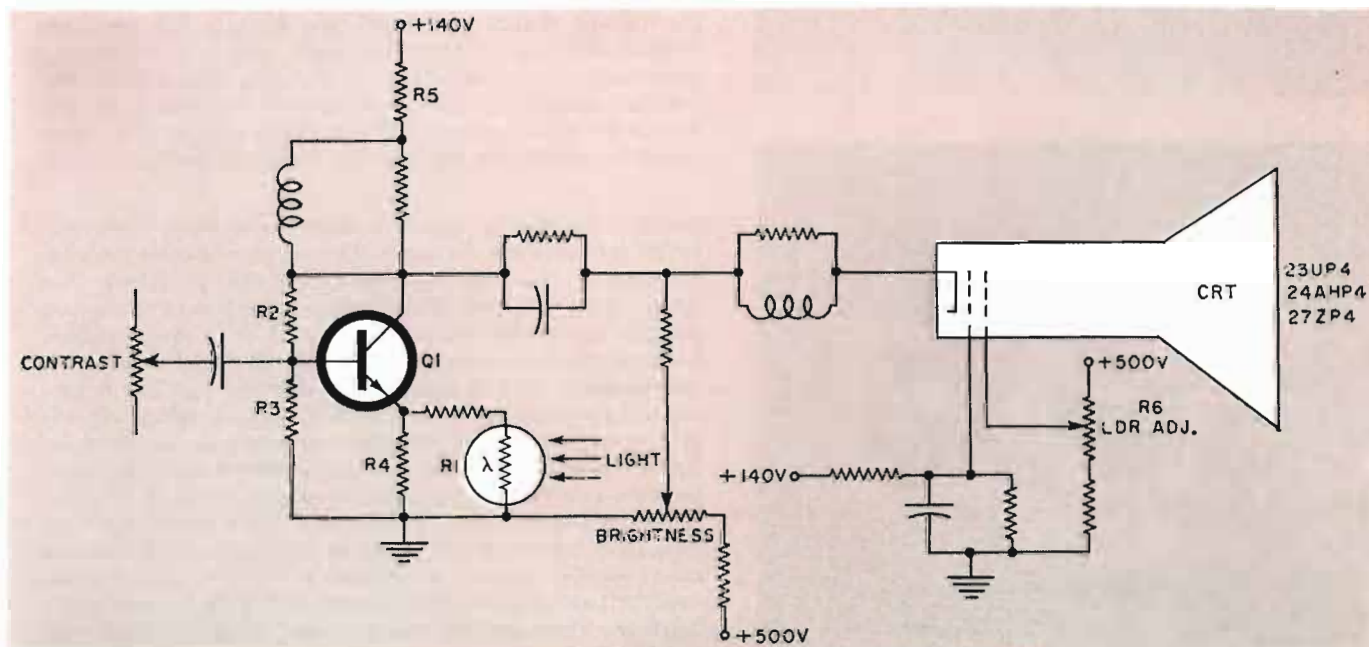



RECENT DEVELOPMENTS IN ELECTRONICS

First Inorganic Liquid Laser. (Top left) A high-energy liquid laser, the first to use an inorganic fluid, has been developed. An experimental model, operated at room temperature, has produced an infrared beam of energy comparable to that of solid-state lasers of similar size. Making the laser is an uncomplicated ten-minute procedure. A bluish powder of the rare earth neodymium oxide is dissolved in a solution of selenium oxychloride, an inorganic substance. The liquid is then transferred to a glass tube, such as the one held by a GT&E lab technician shown. This liquid is the active medium which serves the same purpose as the ruby rod in a solid-state laser. The new inorganic liquid laser emits light at a wavelength of 1.06 microns (slightly more than one-thousandth of a millimeter), which is in the infrared region of the electromagnetic spectrum.



Hospital Closed-Circuit Television. (Center) Mothers of babies delivered at Sacred Heart General Hospital in Eugene, Oregon may learn to bathe and feed their infants by watching CCTV programs transmitted from the hospital nursery. The infant-care programs may be seen on 227 television receivers installed in patients' rooms throughout the hospital. The sets also receive entertainment and news from the regular commercial channels as well. CCTV equipment has also been installed in two operating rooms, outside the emergency entrance, and in the hospital chapel, auditorium, and kitchen. The hospital's medical staff uses the system to watch surgery from the auditorium and lounges throughout the building. Also religious services are transmitted from the chapel and the patients can see their meals being prepared in the hospital's kitchen. The closed-circuit TV system was designed and manufactured by Sylvania.

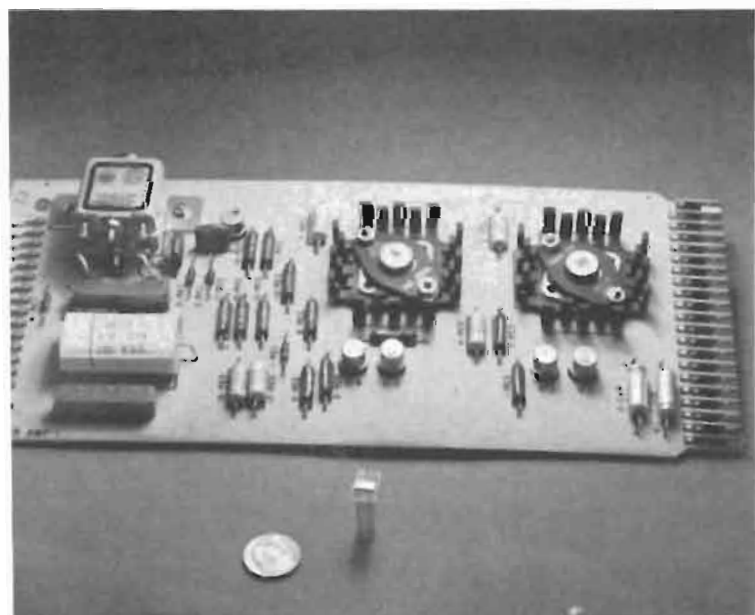

Machine-Tool Control Uses IC's. (Bottom left) Many integrated-circuit elements like the one in the foreground beside the dime are used in a new numerical contouring control system. This single, tiny, integrated circuit is the equivalent of the circuit board in the background which was used in an earlier system. In numerical contouring, material such as metal or wood, is automatically cut and shaped by a machine tool that is programmed by means of a punched tape. Output signals from the tape go into the control unit which subsequently positions the cutter on the tool which can take any position that is determined by three axes of motion. The new system, used by The Cincinnati Milling Machine Co., weighs so little and occupies so little space that an entire three-axis system could be mounted on a machine column or operator's platform, reducing the need for cumbersome cable links between control, console, and machine. The entire control is housed in an air-conditioned cabinet not much larger than previous operator's console.

Electronic Medical System. (Right) A complete system for simultaneously measuring and displaying functional changes that can occur in a patient was demonstrated recently. The system, made by Honeywell, is a combination of several instruments for recording, storing, and displaying medical information. A graphic display of a patient's heart, pulse, or breathing activities is traced on a multi-channel oscilloscope that shows simultaneously up to eight kinds of physiological data on a long-persistence, 17-inch CRT screen. A direct-recording oscillograph can also be used for a permanent display. In addition, an FM magnetic tape recorder is used to record up to eight channels of data, plus voice channel, on half-inch magnetic tape.



Integrated-Circuit Radar Calculator. (Center) Mounted directly above the radar indicator scope is a new radar intercept system, which will enable a radar operator to determine optimum time and course, and to direct interceptors against as many as five targets simultaneously. The small size of the device—it occupies only $\frac{3}{4}$ cu ft—is due to the use of integrated circuits. The Motorola-built unit is designed as an accessory to any general-purpose radar indicator. It determines target position and course automatically and computes speed and projected target position. This is done directly from the radar video data and antenna azimuth information, thus providing a speed and accuracy beyond the capabilities of an operator alone.

Lunar Orbiter Memory. (Below left) This tiny memory, not much larger than five packs of cigarettes, carries all the information needed to shift the Lunar Orbiter into its orbits around the moon, position it for photography, and start the cameras taking photographs of the lunar surface. The unit, built by Electronic Memories, also acts as a speedometer during acceleration of the spacecraft, and provides continuous information on its attitude during rotation. It also issues commands to deploy the spacecraft's four solar panels and two antennas. Drive-current selection and routing are performed by magnetic techniques rather than by the usual semiconductors. Use of the latter would require more components and would be less reliable.



Portable Battlefield Radar. (Below right) A new second-generation man-portable radar for battlefield use is shown here. The unit provides aural surveillance that distinguishes between a walking man and a small moving vehicle out to about 3 miles. A remote indicator is also provided that can be operated from a concealed position as much as 50 feet away from the antenna. This indicator has two ranges (from 0 to about 3 miles and from 3 to about 6 miles) and it provides the usual B-scan and PPI-scan along with a moving-target indication out to the maximum range. The rechargeable battery used will power the radar for 9 hours. The portable battlefield radars will be built for the Dept. of the Army by Airborne Instruments Lab.

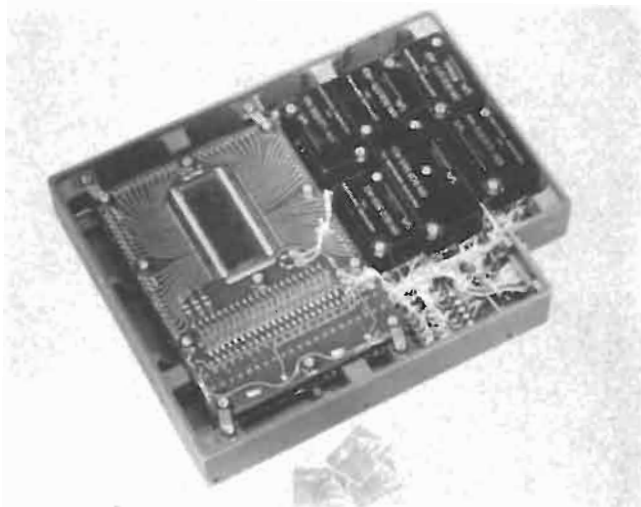

The Tape Cartridge Comes of Age

By LEONARD COPLEN & ROBERT JOHNS

The emergence of the magnetic tape cartridge may be the most important innovation in musical entertainment for the car and the home since the LP record. Dozens of equipment makers are now offering their wares, and many record companies are duplicating their libraries in cartridge form.

TRADITIONALLY, entertainment media like the phonograph, radio, and television, have started in the home and then spread to other locations. Radio, for example, first became popular as home entertainment and then moved out to the family car. The tape cartridge, on the other hand, although introduced in home machines a few years ago, was given real impetus by the availability of cartridge players for the car.

The heart of the system is the cartridge itself, a plastic case that holds a single reel of $\frac{1}{4}$ " tape joined in a continuous loop or two reels of $\frac{1}{2}$ " tape in a conventional reel-to-reel arrangement. The cartridge and the machine designed to play it make up a cartridge system.

There are two leading systems on the market. Both use $\frac{1}{4}$ " tape, operating at $3\frac{3}{4}$ ips, recorded in conventional two-track stereo. In order to put more music into a cartridge, however, both systems record more than one set of tracks per cartridge. One system, usually identified as the *Fidelipac* system, uses four tracks while the other (known as the *Lear* system) employs eight tracks. In other words, the *Fidelipac* 4-track cartridge contains two sets of tracks,

Editor's Note: As we go to press, it appears that the Lear cartridge system described below has a good chance of becoming number 1 in the auto tape-cartridge market. And with the fast-increasing library of 8-track cartridges for this system, home use would seem to be assured. At least this was the feeling of many observers at a recent all-industry tape-cartridge conference held in Chicago. Some of the reasons given are that Ford has decided to stick with the Lear system, and Chevrolet and Plymouth are expected to announce it for next year. Also, the major recording companies are all expected to join the 8-track fold. Don't count out the Philips (Norelco) system, however, which is expected to make a strong bid for this market. If they can't make it in the auto field, they should do well in the portable and home markets.

while the *Lear* carries four. The average music content in both 4- and 8-track systems has been running about 40 to 50 minutes, or the equivalent of a record album (although the *Lear* cartridge is capable of holding 80 minutes of music). In addition, there is a mono 4-track library which contains four bands of music per cartridge.

(Incidentally, the use of *Lear* and *Fidelipac* as descriptive terms is more a matter of convenience than accuracy. For example *TelePro*, the company that owns *Fidelipac*, also manufactures 8-track cartridges and players.)

The question arises as to whether one system will supplant the others, whether all will continue to coexist, whether another system will replace them. In order to understand the situation more clearly, it might be well worth the time to describe the background of the various systems, their strengths, and their weaknesses.

Early Developments

The emergence of the tape cartridge for musical entertainment was preceded by a long period of preparation in radio broadcasting. In the early 1960's, radio stations began using cartridges to program their growing load of

Fig. 1. The *Fidelipac* (TelePro) cartridge consists of a single reel of specially lubricated tape arranged as a continuous loop. The tape comes off the center of the reel and moves around the tape guide and past the two pressure pads and tape head. It then goes between pinch roller and capstan which are on the tape deck and engage the tape through openings in cartridge. The tape then returns to the outside of the tape reel, completing the loop.

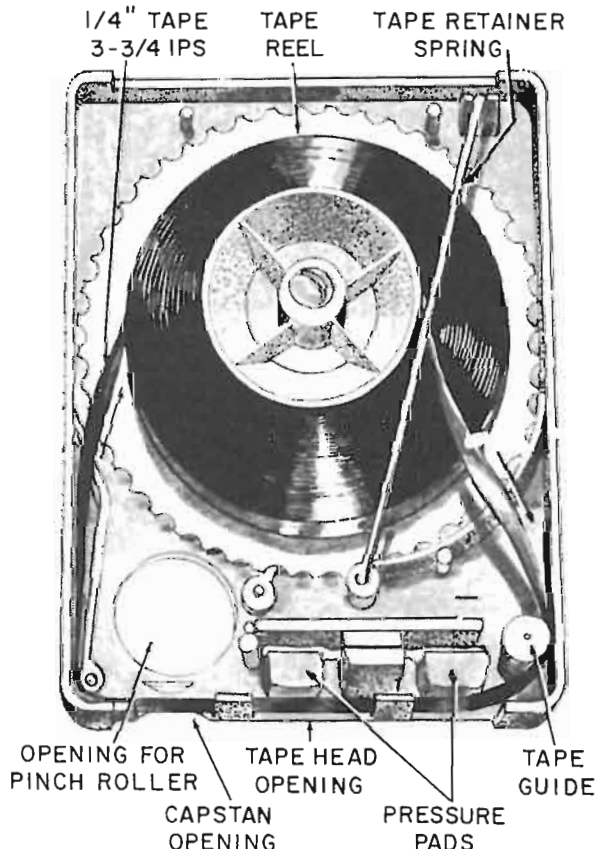

A pair of *Fidelipac* 300-ft cartridges are shown here prior to being loaded with 4-track tape and before label is applied.

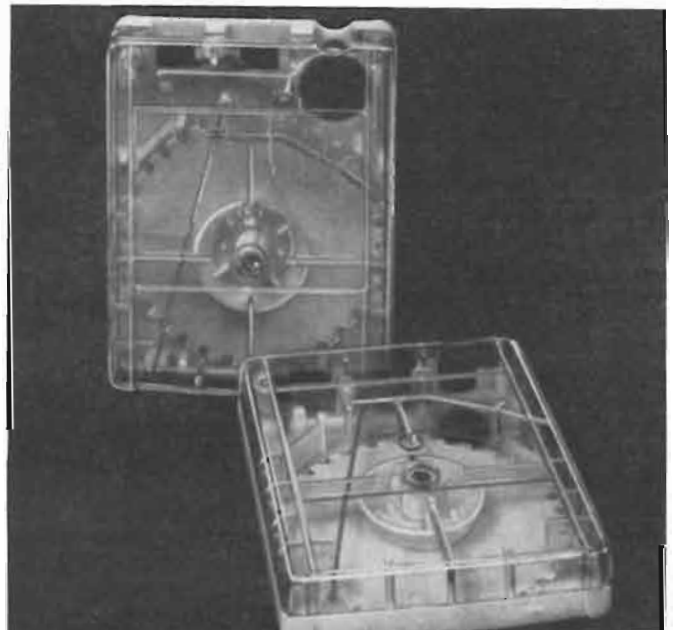



Lear cartridge is about to be inserted into opening above dial of this combination automobile radio and tape playback unit.

commercials. Up to that time, they relied on discs and tapes, which were recorded at different speeds, various sound levels, and required many types of playback equipment. By prerecording their commercials in tape cartridges, they had a foolproof method of arranging a full day's programming in advance with every message in sequence.

Two systems were available at that time, the *Fidelipac* and the *Cousino*. The main difference between the two is in the tape configuration: in *Fidelipac* the tape winds off the reel in a vertical plane and passes the magnetic head in the same plane; in the *Cousino* system, now owned by *Orrtronic*s, the tape makes a half twist and contacts the head in a horizontal plane. Both systems were carried over to the automotive market, where both started out as 4-track stereo systems. Of the two, *Fidelipac* eventually took precedence in both broadcasting and automotive use.

The first man to make an impact in the car market was Earl Muntz. In fact, he might be called the father of the industry since he opened the first market for 4-track auto cartridges in California as early as 1962. Using the *Fidelipac* system, Muntz provided a complete package, both the players and library, which he duplicated through licensing agreements with about 40 record companies, including *MGM*, *ABC-Paramount*, *Verve*, and *Dot*. He currently maintains a 4-track library of about 3000 titles, which he updates every month. Regarding the 4-track equipment now on the road, he estimates that there are about 700,000 *Fidelipac*-type players in use, half of them made by Earl Muntz.

Muntz's use of three different sizes of *Fidelipac* cartridge pretty much set the pattern for the entire 4-track industry. The smallest (a 300-foot tape load) carries 40 minutes of music, the equivalent of one record album; the next size (600 feet) holds 80 minutes of music, the equivalent of two albums; while the largest (1200 feet) contains the equivalent of four albums, or two hours of music. (Fig. 1)

Another name that figures in the history of auto cartridges is *TelePro Industries*, which purchased *Fidelipac*. By the summer of 1963, the company was producing 10,000 cartridges; by 1965 production had risen to 300,000 a month as a direct result of the rapid growth of the car cartridge market. Up to that time, the company did not produce tape players but supplied cartridges to about 12 manufacturers (including Muntz) who marketed their own machines. All of these companies produced 4-track cartridge players that retailed for over \$100.00.

Feeling that too many car owners were being excluded because of high prices, *TelePro* began manufacturing low-cost cartridge players in 1965. The company is responsible for the development of hang-on units, which can be attached quickly and cheaply under the dashboard. These

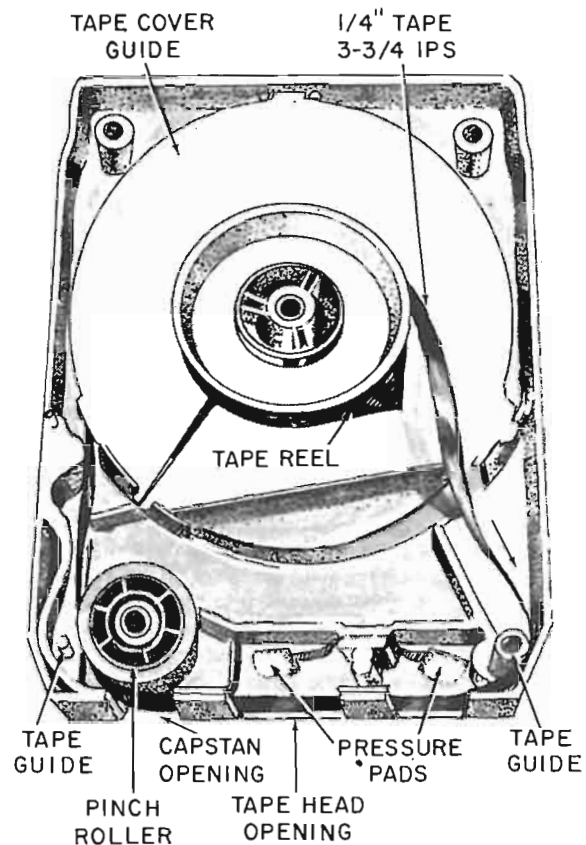

Fig. 2. The Lear cartridge also consists of a single reel of specially lubricated tape in a continuous loop. The operation is similar to the *Fidelipac* except that a pinch roller is built into the cartridge itself and this is engaged by tape capstan.

units operate through the car radio, eliminating the expense of extra amplifiers and speakers. Since the introduction of the low-budget players, the cost of 4-track equipment has dropped to the point where it is now possible to get a home cartridge player for as little as \$30.00.

All of these manufacturers of 4-track equipment serviced what is called the "after market," which means that the consumer buys his accessories *after* his car has left Detroit. This is in contrast to accessories which are installed and delivered by the auto maker—called the "new-car" market. The 700,000 4-track units that are now operating on the road were purchased in the after market.

Lear Enters the Field

In 1965 a new name appeared in the cartridge field when *Lear Jet* presented its 8-track concept to *The Ford Motor Co.* The *Lear* system brought two innovations to the auto cartridge field: it was the first system to break into the new-car market; and it introduced the 8-track cartridge to an industry that had been exclusively 4-track.

The reason for introducing 8-track was classically simple, twice as much music in a cartridge. (A *Lear* cartridge containing 300 feet of tape can carry 80 minutes of music.) *RCA Victor* agreed to duplicate its recordings in 8-track cartridges, and the promise of a major library was enough to commit *Ford* to the 8-track system. In the fall of 1965, *Ford* offered 8-track stereo as optional equipment in its new cars. Over 70,000 units have been sold.

Lear 8-track and *Fidelipac* 4-track cartridges are incompatible. The major difference involves a pinch roller which engages the cartridge with the drive mechanism and causes the tape to rotate. In the *Fidelipac* system the pinch roller is located in the tape player, while in the *Lear* system it is seated in the cartridge itself. Owners of *Fidelipac* cartridges cannot play them on *Lear* machines and *vice versa*.

Proponents of the *Fidelipac* system point out that: (1)

4-track technology was already perfected and in wide use; (2) a set of standards for *Fidelipac* equipment was established by the National Association of Broadcasters (NAB) and these were carried over to the 4-track car market; (3) by using only four tracks, it was possible to record better sound, and; (4) the tolerances in 4-track were less critical and there was less chance of the equipment falling out of alignment.

However, the *Lear* system prevailed at *Ford*, perhaps because of the inherent advantage of being able to double the musical content in a *Lear* cartridge and the subsequent saving of storage space in the automobile.

The debate seemed to have been resolved when *Capitol Records* announced that it would release its library in 8-track and *Chrysler* joined the 8-track fold. If the major record and automotive companies have sided with 8-track, what could the future hold for the 4-track system?

The Competition Continues

The answer was forecast in 1965 when *TelePro* opened up the low-budget market with its hang-on deck. *Muntz* has followed suit with a hang-on unit retailing for \$59.95. Compare this with a new car installation cost of from \$125.00 to about \$180.00 (or a *Lear* hang-on unit for around \$125.00). Furthermore, since most of the low-cost units are designed for external mounting (as opposed to permanent installations in the dashboard), the owner can easily move his cartridge player to his new car at trade-in time and save himself the expense of a new cartridge player.

As a natural outgrowth of the activity in the auto market, many manufacturers are now offering cartridge equipment for the home, where the same controversy continues.

Now let us consider the current 4-track library. There are roughly 40 to 50 labels using the 4-track system. Eliminating those titles which have been dropped over the course of years, there are about 20,000 cartridge titles available. The bulk of this library can be categorized as popular, including collections by well-known pop artists (The Beatles, Tijuana Brass, Sinatra, etc.), show albums, motion picture sound tracks, collections of favorite pop tunes, and mood music. About 5% of the library consists of classics, mainly

the better known symphonies, overtures, operas, and popular concert artists.

Because of its later start, the 8-track library is small and relatively few releases have taken advantage of the 80-minute potential program content. *RCA Victor* has about 300 titles on the market. Some record companies have released both 4- and 8-track recordings, while *Columbia* and *Capitol* are both releasing 8-track. The total number of 8-track titles now available is about 1000.

Both 4-track and 8-track cartridges retail for about \$1 more than an equivalent phono record album.

Meanwhile, both *TelePro* and *Muntz* are making their bid for the teenage market with a miniature 4-track cartridge similar to the 45 rpm single record. These cartridges contain one or two selections and retail for \$1.19. Both companies are marketing low-cost "mini" players to accommodate these short-play cartridges.

If the consumer wants to spend less money for his equipment, he must buy 4-track; if he wants to avail himself of the releases from the major record labels, he may buy the more expensive 8-track. Or, if he wants to have the capability to play both, a number of manufacturers have introduced compatible players that will accept both *Fidelipac* 4-track and *Lear* 8-track. Here, the prices range from \$99.95 for auto units (speakers extra) to about \$160 for integrated home players with speakers.

Orrtronics & Norelco Systems

It is important to note that two other systems are competing for the cartridge market. The *Orrtronics* system (*Cousino*) which was mentioned earlier is now available as an 8-track system. It is incompatible with either *Lear* or *Fidelipac*. Since none of the major record companies (and few of the other companies) are releasing cartridges for this system, it is difficult to see how *Orrtronics* can achieve the popularity of *Fidelipac* or *Lear*. However, the Electronic Industries Association has issued standards of compatibility covering all three systems, and this may help *Orrtronics* in its bid for a share of the cartridge market.

Philips (Norelco), on the other hand, has presented a system which differs completely from the single-reel systems. *Philips* has a reel-to-reel cartridge (cassette) which runs at 1 7/8 ips, using a tape 3/8" wide and carrying four tracks of recorded material. The cassette is one-fourth the size of a *Lear* cartridge and the miniaturization of this system is a marvel to behold. The cassettes provide a normal playing time of 60 minutes, although they must be flipped over at the end of 30 minutes. Recently, the company has come out with a cassette with thinner tape that plays for 90 minutes. The tape players, which are available as both portables and consoles, are most versatile in that some of the decks can be transported from home to car, where they can be plugged into the dash- (Continued on page 96)

Fig. 3. The Philips (Norelco) cassette is a very compact reel-to-reel cartridge using 3/8-in rather than 1/4-in tape. The tape is pulled from one of the reels (acting as supply reel), past a tape-guide idler, and then past pressure pad and tape head. The tape then moves between capstan and pinch roller (both located on the tape deck), around the other tape-guide idler, and then to the other reel (acting as take-up reel). When the cartridge is flipped over, the function of two reels is reversed and capstan and pinch roller are in other openings.

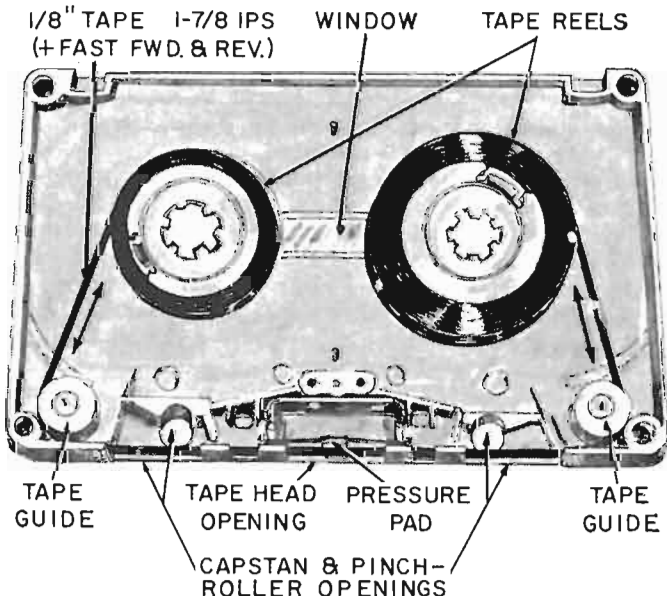

The Philips cassette shown here has a numbered scale over the window to aid in finding a given spot on tape being played.



Power Inductors

By ROBERT E. COY/Engineer, Triad Distributor Div.

How to select the proper iron-core choke for power-supply filtering, as a charging choke for pulse networks, and for interference reduction.

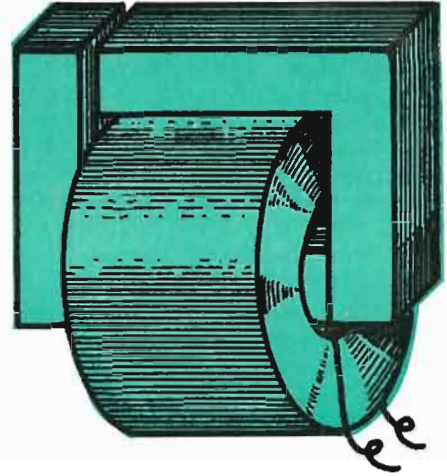

INDUCTORS used in electronic power circuits are characterized by high induction levels, relatively large air gaps in the core, and larger size than other inductor types. Applications for power inductors include: (1) filter reactors for rectifier circuits, both input and smoothing types, (2) charging inductors for pulse networks, (3) interference reduction filters as found in "A+" lines of mobile equipment, and (4) saturable reactors used in some types of control circuits.

Power-supply filters make up a large percentage of power inductor applications, and the considerations necessary for these circuits are much the same as for the other types mentioned.

The important considerations for inductors used in power-supply filter circuits are fewer and more straightforward than for many other inductor applications. An exception, perhaps, is the effects of superimposed direct current in the coil. One of the reasons for this relative simplicity of specification is that power chokes are normally used at a single frequency, that is, the available a.c. power-line frequency, or twice that in the case of full-wave rectification. These frequencies range from 25 Hz in a few countries to the 400 Hz encountered in military aircraft and some shipboard equipment. Thus, it can generally be assumed that the entire frequency range is below 1000 Hz, which virtually eliminates the need for considering such high-frequency parameters as the effects of distributed capacitance and self-resonance.

Rectifier filter circuits may be divided into two groups, depending upon whether a choke or capacitor is used as the first component following the rectifier. Choke-input filters are preferred in cases where good regulation and low surge currents through the rectifiers are important to the power-supply design. The d.c. voltage from a given a.c. source is lower than can be obtained with a capacitor-input filter; however, more current is available from the same source by using the choke input because of the lower current peaks and r.m.s. heating factor.

It is important to use a choke with sufficient inductance to maintain current flow through one leg of the rectifier circuit at all times. There are many formulas for determining the minimum or critical inductance, which usually results in a value (in henrys) approximately one-thousandth the effective load resistance (in ohms) at minimum load.

Many power supplies are designed for use at a single d.c. output current level. In such cases, finding the value of critical inductance is fairly simple. Typical inductance values range from 2 to 25 henrys. In other supplies, the load current may vary over a wide range of values. *Swinging chokes* are often used in such applications, especially in transmitter power supplies where the output current varies

from bleeder current to fairly large values only when the transmitter is keyed. The inductance of these chokes drops off rapidly with an increase in direct current through the coil. A typical swinging choke may have an inductance rating of 5:1 for an increase in current of 10:1. For example, the choke may have an inductance of 25 henrys at 20 milliamperes and drop to 5 henrys at 200 milliamperes. In this way, the choke "adjusts" itself to at least the minimum inductance for all current values.

A second choke, called a *smoothing choke*, is often incorporated in an additional filter section to reduce ripple further than can be economically accomplished with a single input filter. The value of inductance for this choke depends upon the input ripple and the desired amount of ripple reduction for the filter stage.

Charging inductors are used in the charging circuits of pulse-forming networks of radar equipment. They are similar in design and specifications to filter chokes. The inductance value is selected so that the circuit will resonate at one-half the pulse repetition rate. Charging inductors differ from filters in that much higher a.c. flux densities are encountered in charging inductors. Design considerations must sometimes take this into account.

Electrical Characteristics

Most power inductors have a direct current in the winding as well as the a.c. voltage across the terminals. The formula for inductance of an iron-core inductor with superimposed direct current may be stated as follows:

$$L = \frac{3.2 N^2 A_c \times 10^{-8}}{l_g + (l_c / \mu_{\Delta})}$$

where L is the effective inductance in henrys, N is the number of turns, A_c is the net cross-sectional area of the core in square inches, l_g is the total length of the air gap in inches, l_c is the mean magnetic path length of the core in inches, and μ_{Δ} is the incremental permeability of the core material.

The factors in the numerator are straightforward and can be easily understood. The denominator of this equation represents the effective magnetic path length. This effective length is the total length of the air gap and core path lengths divided by their respective permeabilities. (The permeability of the gap may be regarded as unity; therefore, the effective length is that of the gap.) In many cases, the design of a reactor is determined to a great extent by the correct proportioning of these two lengths. *Incremental or effective permeability* (permeability when an alternating magnetizing force is superimposed on a direct magnetizing force) depends upon the characteristics of the core material,

the d.c. magnetizing force set up in the core, and the amount of a.c. flux in the core. Data on permeability is not readily available and is best obtained from the core manufacturers' charts which plot effective permeability against d.c. magnetizing force and a.c. flux density. (See Fig. 1.)

Effective permeability decreases with an increase in d.c. magnetizing force in the core and reduces the effective inductance of the choke. Air gaps may be placed in the magnetic path to absorb some of the d.c. flux, thus reducing the effects of the direct current in the winding. A graph illustrating the effects of d.c. in a typical filter reactor is shown in Fig. 2.

Inductors carrying direct current may be classified as one of two types, *linear* or *non-linear*. Linear reactors are designed with an air gap greater than the effective length of the core (l_c/μ_r). As the permeability of air and the length of the gap are constant, the inductance of the choke will be fairly linear across the range of direct current in the coil.

Non-linear inductors, commonly called *swinging chokes*, are often used when the direct current from a power supply must vary over a wide range of values. They are designed so that a change in direct current will have a definite effect on the inductance. This is done by using little or no air gap so that l_g is small compared with (l_c/μ_r) . Thus, the inductance of the reactor is determined largely by the incremental permeability of the core which decreases with an increase in direct current.

Under normal conditions, the d.c. flux in a filter reactor is much greater than the a.c. flux. For example, filter chokes are usually tested at an a.c. level of 5 to 10 volts and the rated direct current. This typically results in an a.c. flux density of 300 to 1000 gauss and a d.c. flux density of 12,000 to 14,000 gauss. If the a.c. flux were to be substantially increased on an inductor of this type, the total flux could reach the saturation level of the core material, result-

ing in low inductance, non-linearity, and poor filtering in power-supply circuits. For this reason, the a.c. voltage must be specified in inductor performance requirements. In 60-Hz single-phase full-wave rectifiers, the effective a.c. voltage at the choke input is approximately 50% of the d.c. voltage.

If a choke is selected for use in a circuit where high a.c. voltages are present across the coil as well as direct current in the winding, it may be checked on an inductance bridge to determine whether it is suitable for the application. With the specified a.c. voltage across the terminals, direct current through the coil is increased from zero to the rated value, observing the inductance. If the inductance remains relatively linear until the rated value of direct current is reached, the choke should be suitable for the application. If inductance drops off before the rated value of d.c. is reached, core saturation is indicated, and the inductor would not be recommended for use in the application.

In order to maintain good regulation and low losses in a filter section, it is important to keep the d.c. resistance of the inductor at the lowest possible value. The largest wire size consistent with the number of turns required and the winding space available is used to accomplish this. The d.c. resistance can be a determining factor in the size of an inductor, as it may be necessary to increase the core size in order to use a large enough wire to maintain the minimum value. Fig. 3 shows the range of inductance and resistance values generally available from standard lamination sizes having a stack height (L) equal to the length of the center leg.

Insulation ratings are often misunderstood because the rated dielectric strength does not directly indicate the maximum voltage which may be continuously applied. To ensure normal life expectancy, the insulation should be rated for at least twice the r.m.s. working voltage plus 1000 volts for commercial applications. Table 1 shows military ratings set forth in MIL-T-27B. The r.m.s. working voltage is defined by EIA Standard RS-197 as "0.707 times the sum of the maximum d.c. voltage and the peak a.c. voltage which may appear between winding and ground under normal conditions of continuous operation." This method may be used to determine the suitability of an inductor for a specific application by working back from the original formula. Subtract 1000 volts from the specified rating and divide the remainder by two. This gives the maximum r.m.s. working voltage which may be continuously applied.

Heating in power inductors is caused by losses in the core and in the coil. Since most power inductors (with the exception of charging reactors) operate at relatively low a.c. flux levels, core loss makes up a small part of the total. The losses due to the resistance of the winding make up most of the total heating. But since the largest wire size possible is normally used to keep d.c. resistance low, the coil or copper losses are seldom large enough to cause excessive heating.

Inductance values are not significantly affected by temperature variations. However, if a choke is to be used at high ambient temperatures, consideration must be given to the type of insulating materials used in construction of the unit. Furthermore, copper losses and d.c. resistances will increase with an increase in temperature so that it may be necessary to use a larger wire size to offset these additional losses.

Construction

General construction of power inductors varies from open-style, varnish-impregnated units for commercial equipment with few environmental requirements to hermetically sealed types built to withstand the most severe temperature and climatic conditions. Basic coil and core construction is similar for all types.

Power inductors characteristically operate at high induction levels. Silicon steel having 3% to 4% silicon content

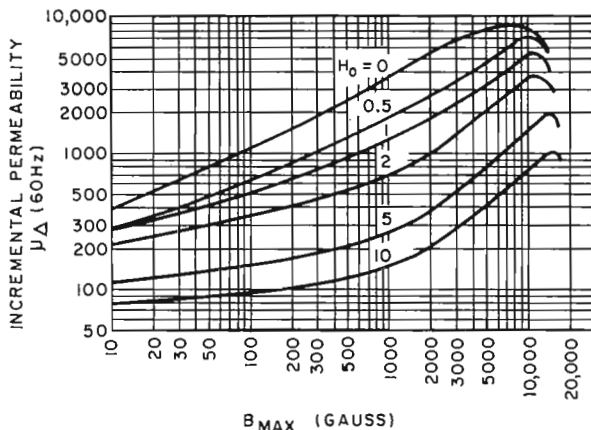
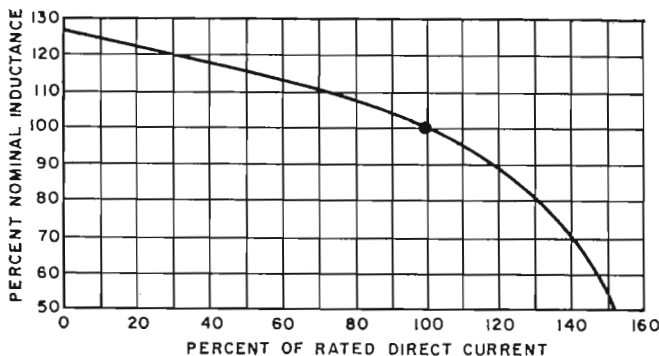
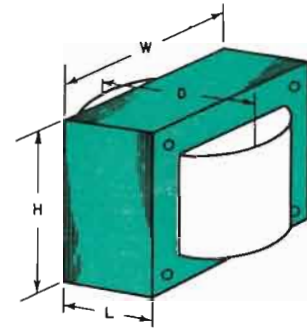
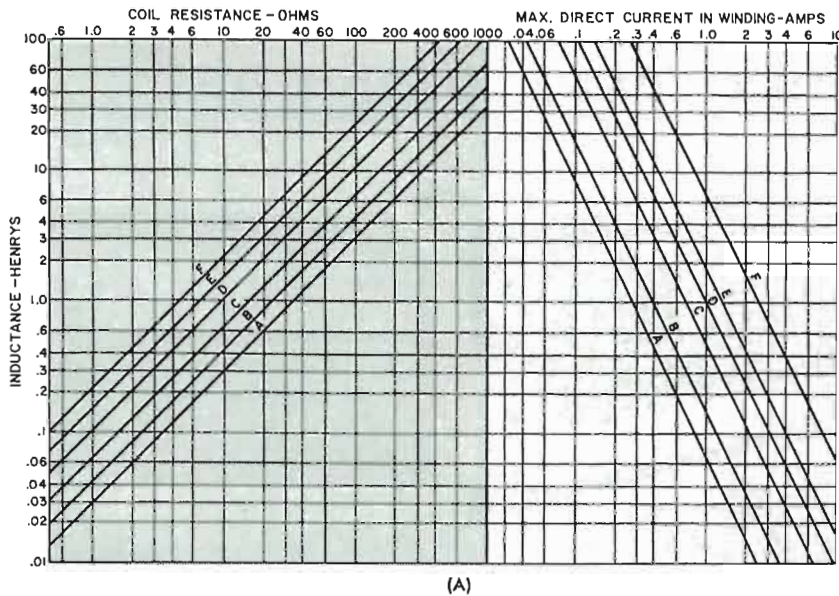

Fig. 1. Incremental permeability curve for AISI grade M-22 laminations where H_0 is the d.c. magnetizing force in core.

Fig. 2. Effect of d.c. in a typical filter choke. Inductance drops linearly until rated d.c. is flowing through coil, then drops rapidly as core saturates. The linear portion of the curve has less slope for inductors which have larger air gaps.





CURVE	LAMINATION	NOMINAL SIZE (in)				APPROX. WEIGHT (lb)
		H	W	L	D	
A	EI-625	1 9/16	1 7/8	5/8	1 1/2	1/2
B	EI-75	1 7/8	2 1/4	3/4	1 3/4	1
C	EI-100	2 1/2	3	1	2 1/4	2 1/2
D	EI-125	3 1/8	3 3/4	1 1/4	2 3/4	5
E	EI-150	3 3/4	4 1/2	1 1/2	3 1/4	8
F	EI-19	4 3/4	7	1 3/4	5 1/4	20

Fig. 3. (A) Typical inductance, resistance, and maximum direct current ratings available with standard-size EI laminations. Assumptions for this chart are: (a) square stack, grain-oriented silicon steel with nominal air gap; (b) maximum current rating is for approximately 50° C temperature rise in open-style unit; (c) maximum number of turns of largest wire size for good design practice; and (d) insulated for 1500-volt dielectric strength. Nominal dimensions for coil and core assembly are shown in (B). For example, it can be seen that the minimum lamination size for a 1.5-henry inductor capable of carrying 1 ampere of direct current would be EI-150. The approximate d.c. resistance is 7 ohms. Dimensions are in part (B).

is widely used for core material because it has a high saturation point and moderate permeabilities. Twenty-four gauge (0.025 inch thick) EI shaped lamination is most common in filter reactors for 60-Hz power supplies, along with 0.019- and 0.014-inch thicknesses. These are normally stacked with a butt stack to provide air gaps. Size and weight can be reduced by using grain-oriented silicon steel material because of the higher induction levels possible. Cost is somewhat higher than standard lamination, but the increased cost is often offset by the savings in size and weight. Because of their low saturation points, higher permeability materials are seldom used in power inductors, except saturable types.

"C" cores are also popular, especially for inductors used in 400-Hz aircraft supplies. Thinner materials are used in these cores, which reduces core losses encountered at these higher frequencies. They are wound with a continuous strip of material, commonly grain-oriented silicon steel, then cut into two C-shaped halves for assembly with the coil. Gaps may be placed between the core halves if desired.

Coils are generally wound in paper-layer construction, with insulating paper between each layer of wire. Bobbin types may be used in some applications, but the paper-layer coil offers better dielectric qualities and is more economical to produce.

As previously mentioned, the largest wire size consistent with winding space available and required number of turns is used in coil construction. In some cases where the wire size requirement exceeds the practical limits of standard wire, copper foil or strips may be used to wind the coil. This is practical only where the inductance value is small, as only one turn per layer is possible.

Table 1. Military dielectric strength requirements (MIL-T-27B).

Working Voltage ²	R.M.S. Test Voltage
≤25	50
>25 to 50, incl.	100
>50 to 100, incl.	300
>100 to 175, incl.	500
>175 to 700, incl.	2.8 × working voltage
>700	1.4 × working voltage + 1000

²Working voltage is defined by MIL-T-27B as "the maximum instantaneous voltage stress that may appear under normal rated operation across the insulation to be considered." Ref. MIL-T-27B, Table XVI.

Insulating materials must be selected to provide the required dielectric strength at maximum operating temperature over the normal life expectancy of the inductor. Besides these characteristics, the material must have sufficient mechanical strength to maintain its insulating properties even after suffering the stresses that are encountered in winding.

Insulating materials are categorized by maximum operating temperature affording normal life expectancy. Both military and commercial specifications list these classes of insulating materials. Although designations for these classes differ for military and commercial classifications, they are similar in temperature characteristics. A listing of both classes is shown in Table 2. Unless otherwise specified, commercial units are normally constructed using class A insulating materials capable of continuous operation at 105° C maximum for normal life expectancy. This corresponds to military class R. The operating temperature includes the ambient temperature surrounding the unit and the allowable temperature rise of the unit.

External packaging is determined to a large extent by the amount of protection required. In military applications, hermetically sealed types are generally preferred, although the encapsulated and molded types are increasing in popularity. In commercial applications, where equipment will be operated under normal room temperatures, open-frame construction is often quite adequate.

Other factors that determine packaging are space available in the equipment, heat dissipation, and, of course, the cost of the item. Open construction offers better heat dissipation and lower cost but is not capable of withstanding severe climatic conditions. The (Continued on page 78)

Table 2. Temperature classifications of insulating materials.

Military Class	Commercial Class	Maximum Temperature °C	Typical Materials
Q	—	85	Cotton, silk, paper
—	O	90	Cotton, silk, paper
R	A	105	Cellulose acetate, paper
S	B	130	Mylar, glass fabric
V	F	155	Glass fabric
T	—	170	Mica, asbestos, silicon glass
U	—	170+	Mica, glass fabric
—	H	180	Mica, asbestos, silicon glass
—	C	180+	Mica, glass

DIRECTORY OF MOST POPULAR, LOW-PRICED VIDEO TAPE RECORDERS



PHOTO	Model	Number of Heads	Tape Size Used (in)	Reel Size (in)	Tape Speed (ips)	Record-Playback Time (min)	VIDEO				
							Input Level (V) and Impedance (Ω)	Output Level (V) and Impedance (Ω)	Response (MHz)	Horizontal Resolution (lines)	
AMPEX CORP., 401 Broadway, Redwood City, California 94063											
A	VR-6000	1	1	9 $\frac{3}{4}$	9.6	60	1	75	R.F. 30mV ⁱ 300	2.5	250
B	VR-7000	1	1	9 $\frac{3}{4}$	9.6	60	1	75	1 75 R.F. 30mV ⁱ 300	3.5	350
CONCORD ELECTRONICS CORP., 1935 Armacost Ave., Los Angeles, California 90025											
C	VTR-600	2	$\frac{1}{2}$	7	12	60	1	75	1 75	2.5	250
GENERAL ELECTRIC CO., Audio Products Dept., Decatur, Illinois											
D	—	2 B/W 4 color	$\frac{1}{2}$	7	7 $\frac{1}{2}$ B/W 11 $\frac{3}{4}$ color	90 B/W 60 color	—	—	—	—	—
IKEGAMI ELECTRONICS IND., INC., OF NEW YORK, 501 5th Avenue, N. Y., N. Y. 10017											
E	TVR-301	2	$\frac{3}{8}$	7	12	45	.7	75	.7 75	2.7	220
F	TVR-311	2	1	9 $\frac{1}{2}$	9.6	66	.5	75	1 75	3.5	280
INTERNATIONAL VIDEO CORP., 330 Village Lane, Los Gatos, California 95030											
G	IVC-500	1	1	8	6.5	60	.5	—	1 —	4.5	—
MATSUSHITA ELECTRIC CORP. OF AMERICA, 200 Park Ave., N. Y., N. Y. 10017											
H	Panasonic Tape-A-Vision	2	$\frac{1}{2}$	7	12	40	.4	75	1 R.F. 75 300	2	200
NORTH AMERICAN PHILIPS CO. INC, 100 E. 42nd St., N. Y., N. Y. 10017											
I	EL3400	1	1	9	9	60	1	75	1 R.F. ^h 75 300	2.5	285
REVERE-MINCOM DIV., 3-M CO., 2501 Hudson Road, St. Paul, Minnesota 55119											
J	Wollensak VTR-150	1	$\frac{1}{2}$	8	7 $\frac{1}{2}$	60	1	75	1 75	2	—
SHIBADEN CORP. OF AMERICA, 58-25 Brooklyn-Queens Expressway, Woodside, N.Y. 11377											
K	SV-700	2	$\frac{1}{2}$	7	7 $\frac{1}{2}$	60	.5	75	1 75	3	300
K	VRM-416	2	1	10	9	80	1	75	1 75	—	400
SONY CORP. OF AMERICA, 580 5th Ave., N. Y., N. Y. 10036											
LM	CV-2000 D Color VTR	2	$\frac{1}{2}$	7	7 $\frac{1}{2}$	60	"	—	1.4 — 75	—	200
N	Portable VTR	2	$\frac{1}{2}$	7	12	60	"	—	—	—	250
N	Portable VTR	2	$\frac{1}{2}$	5	7 $\frac{1}{2}$	30	"	—	—	—	—

a—camera; b—monitor; c—camera tripod; d—microphone; e—recorder, camera, and monitor as a package \$1609.50; f—r.f. modulator; g—price depends on packaging and whether black-and-white or color; h—v.h.f. channels 2, 3, and 4; i—console version VTR-15MC includes recorder, receiver, camera, tripod, headset, microphone \$2995.00; j—VR-7100 Videotrainer including VR-7000 deck, camera, monitor, and microphone

Besides the models covered in this table, several more companies have a VTR under development. These include the Japanese manufacturers Oki, Akai, Sanyo, Toshiba, and Victor; and the American companies Fairchild Industrial Products, Defense Electronics, Paco, Par Ltd, and the ITT Research Institute (Illinois Institute of Technology).

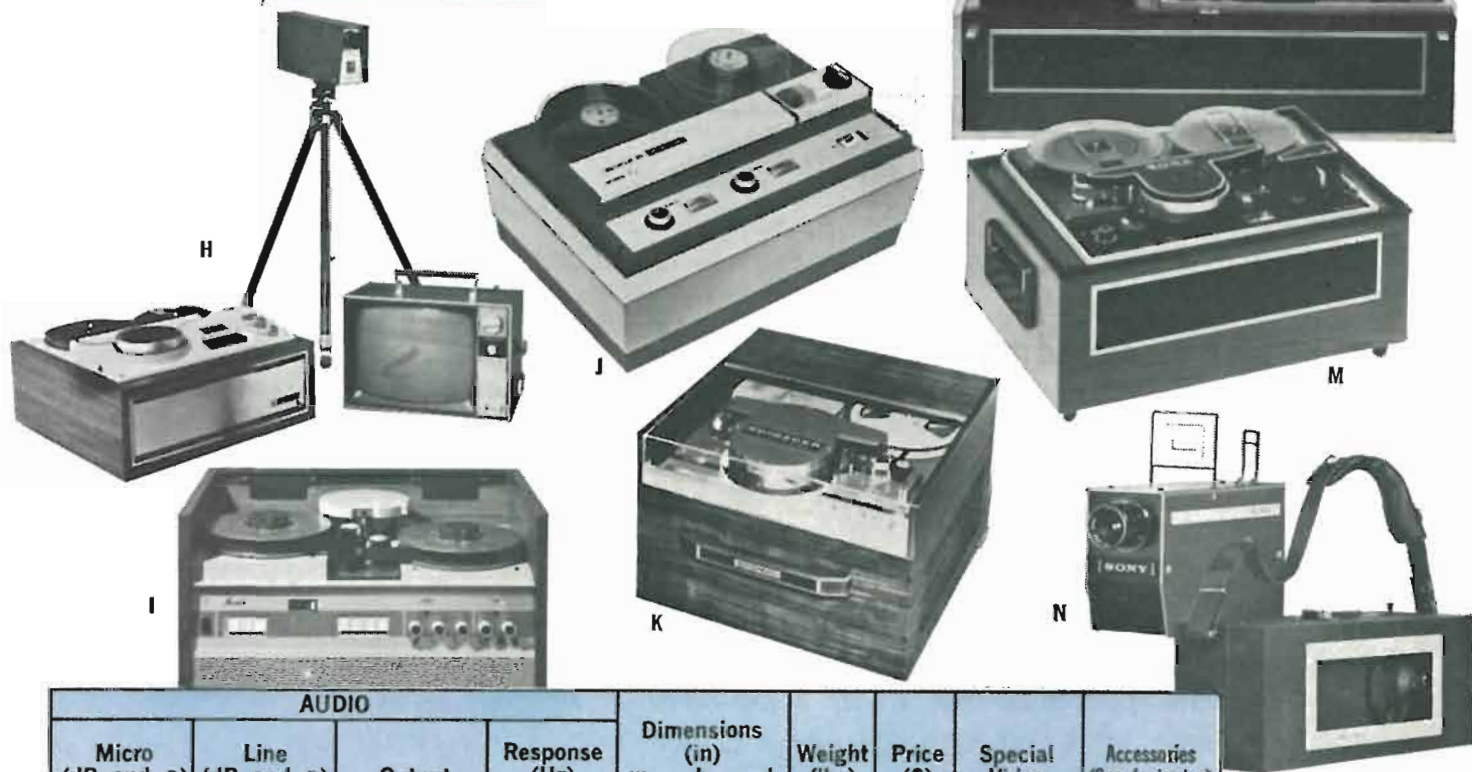

AUDIO				Response (Hz)	Dimensions (in)			Weight (lbs)	Price (\$)	Special Video	Accessories (See footnotes)
Micro (dB and Ω)	Line (dB and Ω)		Output		w.	h.	d.				
— 50K	— 100K	— 100K	4 dBm 600 Ω	90--9,000	—	—	—	85	1295*	—	a, b, c, d
.2 mV 200	.12 V 100K	100K	8 Ω 6W	50--12,000	29 $\frac{3}{4}$	13 $\frac{3}{4}$	20 $\frac{1}{4}$	100	3150 [†]	—	a, b, c, d
1 mV 20K	1 V 1 Meg.	1 V	600 Ω	60--12,000	17	10	16 $\frac{1}{2}$	52	1150*	—	a, b, d, f
—	—	—	—	—	—	—	—	—	850--4000 [†]	color	a, b, c, d
-72	600	-22 50K	0 dBm 600 Ω	10--10,000	15.6	11.6	14.3	51.7	—	—	a, b, c
-70	600	-10 50K or 600	0 dBm 600 Ω	100--10,000	25	11.5	17	90	—	slow motion, stills	a, b, c
-60	10K	0 600	1 V 600 Ω	50--10,000	19	8	12 $\frac{1}{4}$	38	1200--1500	color	a, b
-60	20K	0 1Meg.	—	80--10,000	16 $\frac{3}{8}$	9 $\frac{7}{16}$	16 $\frac{1}{16}$	54.5	1500	—	a, b, c, d, f
1 mV	1K	200mV 500K	1 V 20K	120--12,000	24 $\frac{3}{4}$	16 $\frac{1}{2}$	15 $\frac{1}{4}$	100	3450	—	—
.2 V	10K	—	.5 V 10K	50--10,000	20	9	14	50	1495 [†]	—	—
-60	—	-10	-10 dBm 10K	50--10,000	15 $\frac{3}{4}$	9 $\frac{1}{2}$	15 $\frac{3}{4}$	66	1295	—	—
-70	—	+4	—	50--10,000	31 $\frac{1}{2}$	19 $\frac{3}{4}$	16 $\frac{3}{4}$	143	10,000	color, slow-motion	a, b, c, d
-60	600	-2 Hi Z	0 dBm Hi Z	80--10,000	19 $\frac{3}{4}$	9 $\frac{7}{16}$	15 $\frac{3}{4}$	42.5	695	—	a, b, c, d, m
—	—	—	—	—	27 $\frac{1}{2}$	11	16 $\frac{1}{4}$	66	—	—	—
—	—	—	—	—	5 $\frac{1}{2}$	4 $\frac{1}{2}$	12 $\frac{3}{4}$	9.5	1000	battery powered	p

\$5995.00; k—VR-6275 version \$1495.00; l—v.h.f. channels 2 through 5; m—Model TCV-2010 includes 9-inch monitor, \$995.00; Model TCV same as TCV-2010 except for cabinet and includes automatic timer, \$1150.00; n—Sony CVC-2000 camera only; p—12-V.d.c. supply Sony BP-7/564; q—special portable self-powered camera.

By DONALD E. LANCASTER

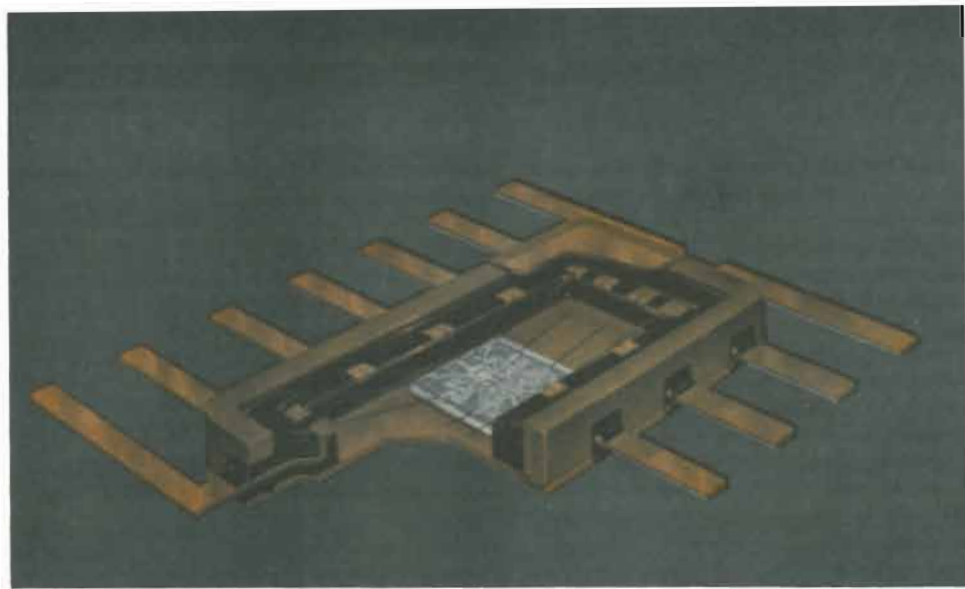

Cutaway view of integrated circuit mounted in 14-lead flat pack.

Linear Integrated Circuits: What's Available?

A survey of what the various manufacturers are now offering, arranged by circuit application. The article discusses where IC's can be used, their specs, what they cost, and how they are designed into circuits.

THE big breakthrough has arrived. Linear integrated circuits are finally distributor stock items, and they are available today in a wide variety of sizes, performance levels, and circuits from at least a half-dozen major manufacturers. Many linear IC's are now quite low in cost, with many devices in the \$2 to \$12 each price range.

For instance, a complete TO-5 can sized i.f. strip for a television set or FM receiver can be purchased for \$2.65. A hearing-aid-sized audio amplifier can be obtained for

\$10.50. One r.f. amplifier costs \$4.40, a second \$4.50, and a third \$4.80. Other linear integrated circuits are still very high-priced, but these frequently offer performance advantages unavailable in any other form of circuitry.

Let's take a closer look at some of the more noteworthy linear integrateds. Everything to be described is *now* distributor stock and available for immediate use. Prices in parentheses are approximate single-quantity cost at the time of publication. Sources of data sheets and distributor lists are indicated in Table 1.

Fig. 1. The circuit of the Westinghouse WC183, a class-B audio amplifier IC which combines high gain and up to 100-mW output.

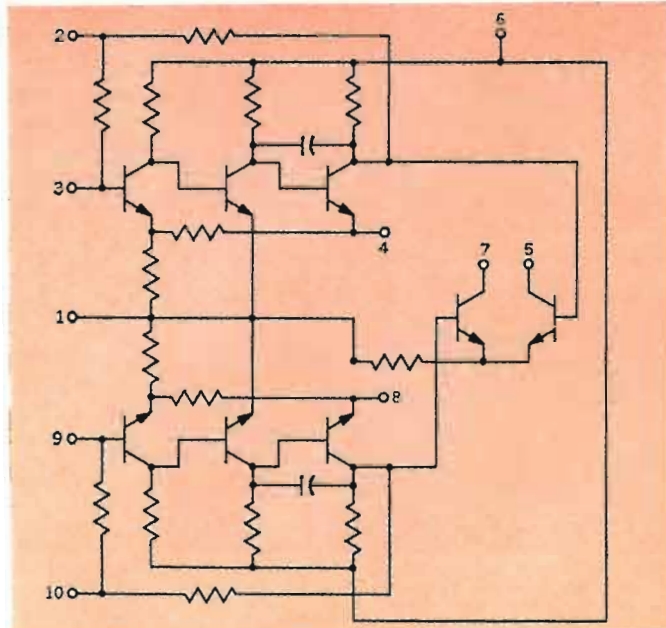

Audio Amplifiers

The *Texas Instruments* SN1220 (\$16.20) is a linear IC designed specifically for hearing aids but also useful for a wide variety of very-low-level, high-gain audio applications. The frequency response has been optimized for voice applications. Maximum output power is three milliwatts at a 5% distortion level, and total voltage gain is 16,000 (84 dB) when the device is powered by a single 1.5-volt, 4-milliampere cell. The ten-lead flat pack used has provision for an external gain control. Either an output transformer or a center-tapped earphone is normally required. The single-cell operation is a most important advantage for subminiature hearing aids as well as orbital satellite applications.

More audio power is offered by the *Westinghouse* WC183 (\$10.50), the circuit of which is shown in Fig. 1. Available either in a ten-lead flat pack or a twelve-pin TO-5 style can, this linear IC is able to produce as much as 100 milliwatts of audio output with a voltage gain of over 30,000 (90 dB). Frequency response is flat from 50 Hz to beyond 20 kHz, and reasonable audio quality may be obtained at low output levels. Although 6 volts is required for maximum gain and output, the WC183 will also operate with a single 1.5-volt cell. In this mode, a voltage gain of 4000 (72 dB) is combined with a three-milliwatt output.

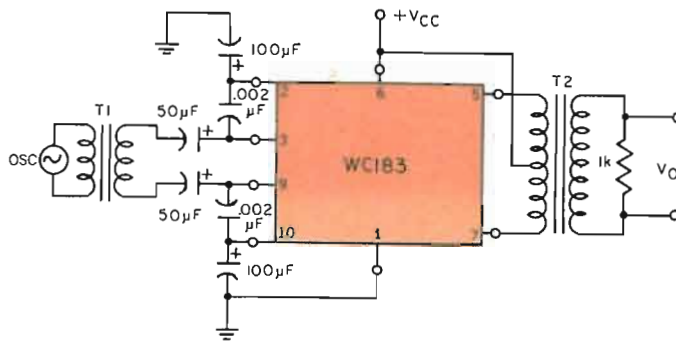
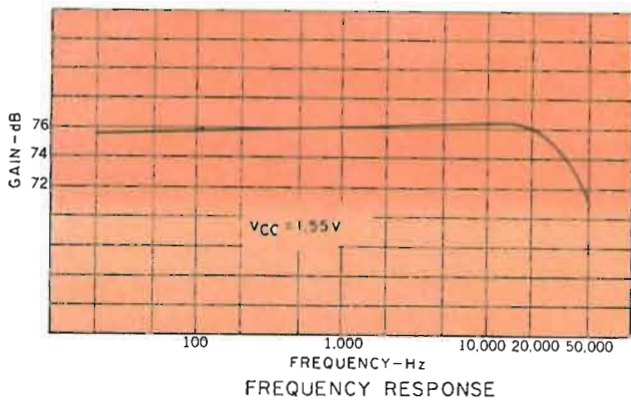

TRANSFORMERS:
T1—GENERAL RADIO TYPE 941-A OR EQUIV.
T2—PEERLESS TYPE E-204-D OR EQUIV.

WIDE-BAND AMPLIFIER

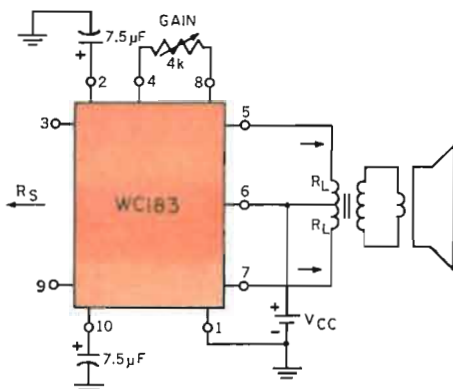

R_S —TYPICAL 5000 Ω A.C. AND 600 Ω D.C.
 R_L —TYPICAL 250 Ω A.C. AT 1kHz

AUDIO AMPLIFIER

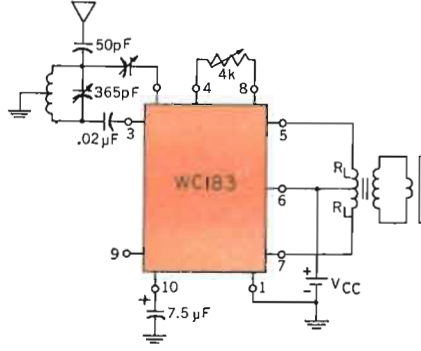

R_L —TYPICAL 250 Ω A.C. AT 1kHz

BROADCAST-BAND REGEN. RECEIVER

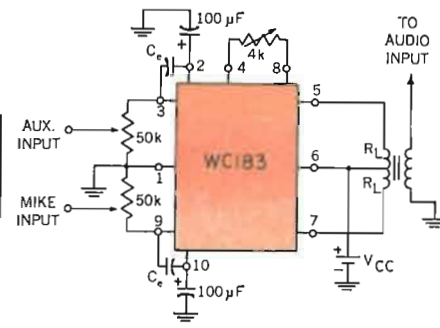

R_L —TYPICAL 250 Ω A.C.
 C_e —EQUALIZATION CAPACITOR

AUDIO MIXER

Fig. 2. Frequency response along with a number of typical circuit applications for the WC183 integrated circuit.

The WC183 is particularly suited to experimental uses, some of which are suggested in Fig. 2. Sufficient audio power is available for low-level recorder monitors, intercoms for low-noise areas, and similar applications.

Higher Power Audio IC's

The RCA CA3007 (\$6.00) is an audio driver that may be combined with an output stage and transformer to produce 300 milliwatts or more of audio power. This twelve-pin TO-5 style package provides a power gain of 160 (22 dB) and is supplied with push-pull input and output. It serves nicely as a transformerless phase splitter and driver for class-B audio-output stages. Feedback is easily provided to automatically hold the output stage bias levels at optimum values.

Higher power audio IC's are still scarce and expensive, owing to the heat problems associated with substantial signal levels. Motorola's MC1524 is one 10-pin TO-5 style can linear IC that can supply one watt of audio-output power. It is oriented towards a military transceiver market and, as such, has a military reliability and a military price tag (\$70). A hybrid construction technique is used in which the lower level circuitry is fully integrated, while the output stage consists of discrete transistors. A photo of the unit is shown on page 41.

Incidentally, for those with a military budget, this amplifier is strictly hi-fi. It has a voltage gain of 1000 (60 dB) and can provide 900 milliwatts of audio output with less than 0.6% harmonic distortion. Frequency response is flat from 20 Hz to over 300 kHz. Dual 6-volt supplies are required.

Low-cost, high-power audio integrateds are still well around the corner and will stay there until a better means of heatsinking IC's becomes practical or else until the switching-mode audio-amplifier schemes become more fully developed. NASA has recently demonstrated a one-watt

switching-mode (class-D) audio amplifier that may readily be integrated. This is an important step towards solution of the high-power audio-IC problem.

R.F. and I.F. Amplifiers

R.f. and i.f. amplifiers form the application area where the majority of low-cost linear integrateds have recently been introduced. Fairchild's μ A703 (\$4.50) is an interesting entry. This 8-pin TO-5 style package functions as a self-limiting i.f. amplifier with up to 41 decibels (112:1) of voltage gain and may be operated either single-ended or

Table 1. Sources of linear IC's covered in the text.

FAIRCHILD SEMICONDUCTOR 313 Fairchild Drive Mountain View, California
GENERAL INSTRUMENT SEMICONDUCTOR 600 West John Street Hicksville, New York
GENERAL MICROELECTRONICS INC. 2920 San Ysidro Way Santa Clara, California
MOTOROLA SEMICONDUCTOR Box 955 Phoenix, Arizona 85001
RADIO CORPORATION OF AMERICA Electronic Components and Devices Harrison, New Jersey
TEXAS INSTRUMENTS P.O. Box 5012 Dallas, Texas
WESTINGHOUSE MOLECULAR ELECTRONICS Box 7737 Elkridge, Maryland 21227

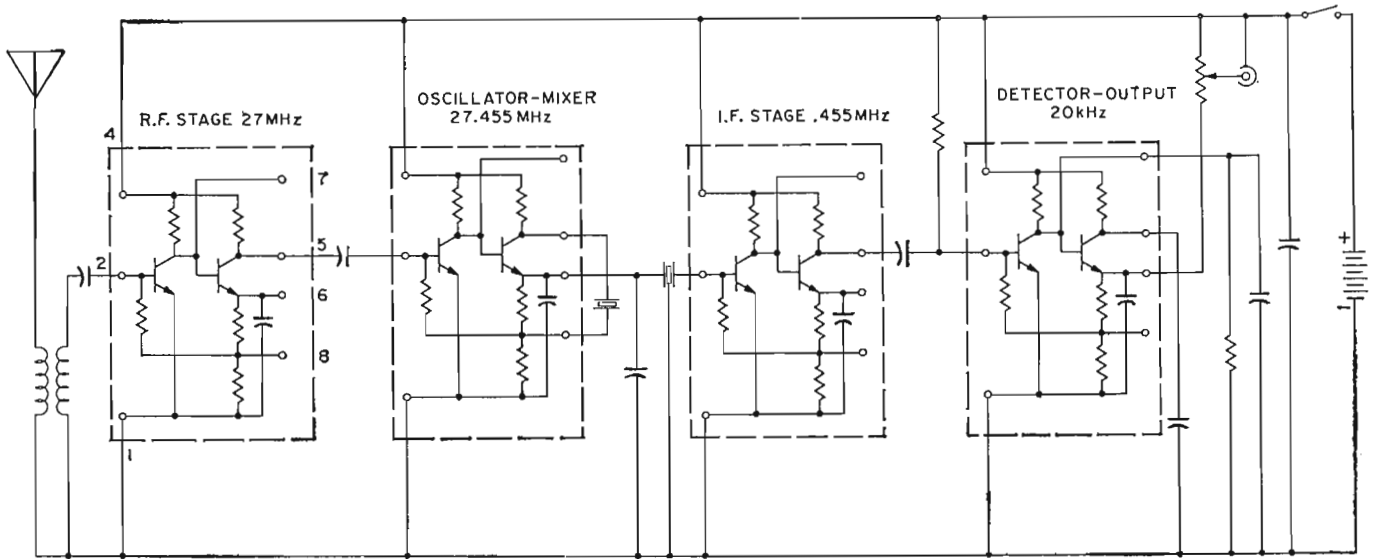

Fig. 3. A Citizens Band receiver using four WC1146 wide-band integrated-circuit amplifiers.

push-pull. The limiting action is symmetric and non-saturating, making the $\mu A703$ excellent for high-quality FM i.f. strips. (See the article "An Integrated Circuit for Consumer Products" in our October issue.—Editors) For non-i.f. applications, this IC also serves as a wide-band amplifier, a voltage-controlled oscillator, or an FM mixer useful above 100 MHz.

RCA's i.f. amplifier, the CA3002 (\$4.40), is similar in purpose but has the added feature of a 10,000:1 (80 dB) electronic gain control (a.g.c.) range. A push-pull input is combined with a single-ended output, and an internal coupling capacitor is provided for direct interstage coupling in the 1- to 10-MHz range. Additional capacitance or transformer coupling may be used at lower frequencies. Voltage gain is typically 10:1 (20 dB). This same IC is also useful as a product detector, a Schmitt trigger, or a wide-band amplifier.

Westinghouse's candidate is the WC1146 (\$10.50), a universal direct-coupled, two-stage negative-feedback amplifier that may be used for virtually any r.f. or i.f. application below 100 MHz. For instance, Fig. 3 shows a high-quality Citizens Band receiver which uses nothing but the WC1146's throughout. One serves as an r.f. stage, followed by an oscillator-mixer, an i.f. stage, and finally a detector and audio-output stage. An input antenna transformer, a ceramic filter, a crystal, and several capacitors complete the circuit. Each IC is capable of a high-frequency gain of 6:1 (16 dB), and automatic gain control is available.

Excellent high-frequency performance is obtainable in the Motorola MC1110 (\$25), an emitter-coupled amplifier good to 300 MHz. The five-lead TO-5 style can IC offers a power gain of 400 (26 dB) at 100 MHz, with a typical noise figure of only 4 dB. The MC1110 operates over a -55 to $+125^\circ\text{C}$ range and is well suited for front-end, r.f., and i.f. applications in high-quality communications gear. Typical is the radar 60-MHz i.f. strip shown in Fig. 4 which

offers a power gain of 80 dB with a 6-MHz bandwidth and a 6-dB noise figure. Four IC's are needed.

RCA's CA3004, CA3005, and CA3006 (\$4.40, \$4.80, and \$6.80) round out the r.f. and i.f. linear-IC picture. These consist of a differential input stage and an internal controlled-current source. The amplifiers may be operated either in a differential or a cascode manner. No collector resistors are provided, as these IC's are normally used in transformer-coupled applications where interstage transformers determine the over-all frequency response. The three IC's differ in input offsets, gain, and linearity. All are potentially useful from d.c. to 100 MHz and have a very good a.g.c. capability. Important applications include use as detectors, mixers, limiters, modulators, and as cascode r.f. amplifiers.

Differential Amplifiers

It is sometimes desirable to compare two input signals against each other and produce an output proportional to the difference between the two. This is often done in d.c. amplifying systems, servo loops, error detectors, and regulated power supplies.

A differential amplifier is normally called on in these applications. Formerly, this meant expensive matched transistors, critical heatsinking, and perhaps external stabilization circuits to obtain good d.c. performance. Linear integrations eliminate all of this. The transistors in an IC are practically identical in size and material. Due to their proximity, they must be at the same temperature, so the transistors track beautifully over wide temperature ranges.

Several companies manufacture linear-IC differential amplifiers. The Westinghouse WS115T (\$10.50) offers some interesting performance features. It consists of four Darlington-connected differential emitter-followers combined with an internal controllable current source. Input impedance is typically half a megohm and the frequency response

Fig. 4. A 60-MHz radar i.f. amplifier using four MC1110 IC's.

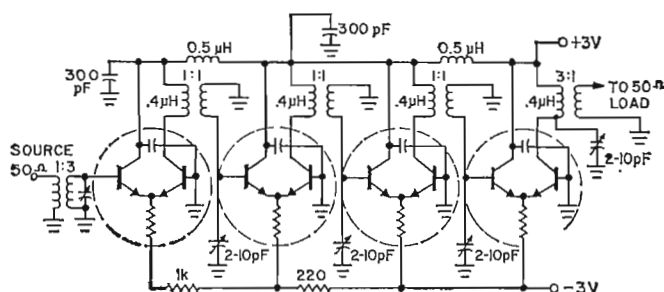

Close-up of an integrated circuit in well of a flat pack.

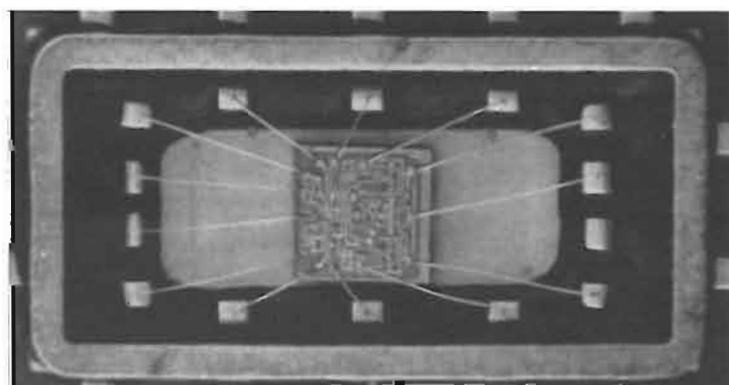

is good from d.c. to 150 kHz. Drift is typically 10 microvolts per degree C, which means that over a 100° C operating range, an "extra" millivolt may appear at one input with respect to the other. For wide temperature operation, input signals as small as 10 millivolts may be processed with little error. Limited temperature range circuits will allow the d.c. processing of 100-microvolt input signals. The WC115T offers a voltage gain of 50 and comes in an eight-lead TO-5 style can.

Motorola has a whole family of integrated differential amplifiers. The most versatile is perhaps the MC1519 (\$50), as *n-p-n* input transistors are combined with complementary matched *p-n-p* output transistors. This *n-p-n/p-n-p* configuration allows a variety of interconnections, all of which readily track over a wide temperature range. A gain of 4500 is combined with a 1-MHz bandwidth in the ten-lead TO-5 type package.

The Motorola MC1525 through MC1528 devices make up a family of medium-priced differential amplifiers, available either as all *p-n-p* or all *n-p-n*, with or without Darlington inputs. An *n-p-n* and *p-n-p* IC may be cascaded for extremely high gain and excellent temperature tracking.

One of Texas Instruments' differential amplifier IC's is the SN723 (\$27.60). Housed in a 14-lead flat pack, this particular IC offers a voltage gain of 1800 (65 dB), a 150-kHz bandwidth, and a 250-ohm output impedance. The SN723 normally uses dual 12-volt power supplies.

Operational Amplifiers

An operational amplifier is any high-gain d.c.-coupled bipolar amplifier with low offset. Its unique performance feature is that the gain may be precisely controlled by external resistors and capacitors. Operational amplifiers have long been used in analog computers, but because low-cost linear IC operational amplifiers are now available, this basic amplifier is beginning to find very wide use. Once again, linear IC's eliminate many of the temperature and tracking problems that formerly plagued the discrete tube and transistor circuits. External stabilization is now only very rarely required, thanks to the performance capabilities of today's linear IC's.

Important operational-amplifier applications are in precision waveform generation, controllable gain and bandwidth amplifiers, d.c.-coupled amplifiers, and active network synthesis. The latter is a new way of using resistors, capacitors, and operational amplifiers to simulate inductance and LC filters without using coils or transformers.

A complex IC shown here along with some grains of rice.

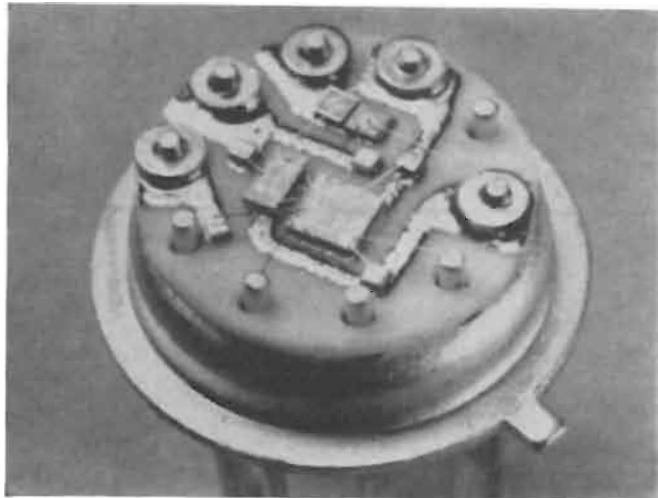
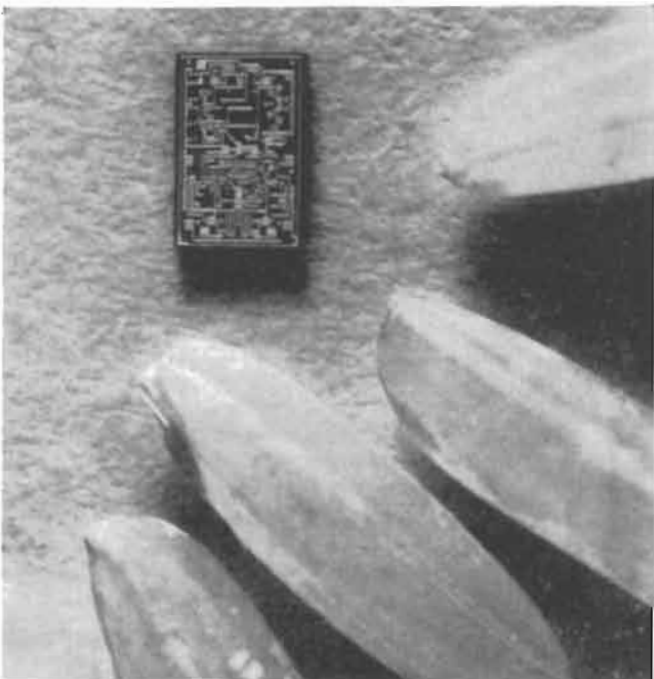

One-watt audio power amplifier using hybrid IC technique.

RCA's CA3010 (\$12) is one of the lowest priced operational amplifiers available today. It offers a voltage gain of 1000 (60 dB), a 300-kHz bandwidth, and a peak-to-peak output swing of seven volts. The CA3010 is housed in a 12-lead TO-5 style case. A second IC, the CA3008, is the identical circuit in a flat package at a slightly higher cost.

Motorola offers four operational amplifiers, the MC1430, MC1431, MC1530, and MC1531 (\$18 to \$30), which differ mostly in input impedance and operating temperature ranges. Darlington inputs are supplied on the MC1431 and MC1531.

Texas Instruments produces one low-cost operational amplifier, the SN724 (\$16.20), and several premium units which are primarily intended for military usage. All are in the ten-lead flat package.

The Westinghouse line consists of half a dozen IC's ranging in price from \$20 to \$70. One dual unit offers two independent operational amplifiers in a single TO-5 style package. Since operational amplifiers are often used in groups, such a configuration results in reduced space requirements and simplified wiring.

Fairchild supplies four distributor stock operational amplifier IC's, the μ A702 and the μ A709. Each has a commercial "C" version and a military "A" version as identified by a suffix (\$14 to \$22).

There are many other operational amplifiers on the market, but most of the ones we have not mentioned are premium units of limited availability. The choice of which operational-amplifier IC should be employed is highly dependent upon the specific application, and a careful study of the data sheets of likely candidates is in order before a particular device is selected.

Other Amplifiers

The CA3000 (\$6.80) is an RCA ten-pin TO-5 style linear IC intended for d.c. amplifier use but also quite applicable to feedback amplifiers, crystal oscillators, modulators, and mixers. It consists of four transistors in a differential Darlington configuration and a controllable transistor and two-diode current source. A 200-ohm input impedance is combined with a voltage gain of 50 and a d.c. to 30-MHz frequency response.

A second RCA linear IC, the CA3001 (\$6.40), is intended for video amplifiers and other wide-band amplifier applications. Circuitry is somewhat similar to the CA3000 except that emitter followers are added for low output impedance and internal coupling capacitors are provided. This IC has a push-pull input and output, a 9:1 voltage gain, and a 16-MHz frequency response. The circuit finds use in video amplifiers and other wide-band amplifiers

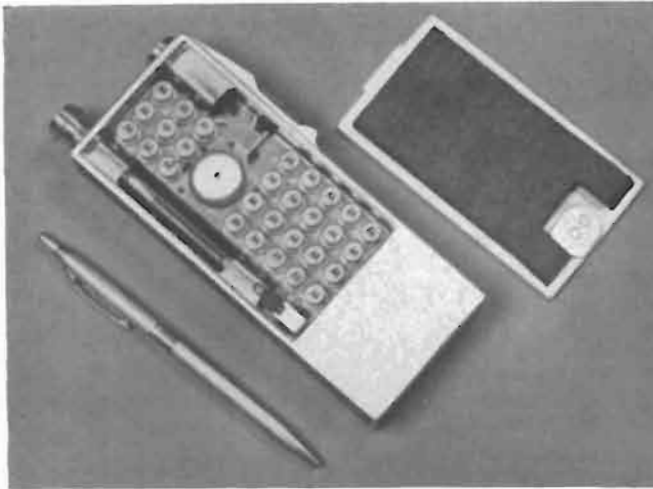

A complete 120-MHz transceiver built with linear IC's.

where the balanced, push-pull configuration serves to keep r.f. signals off the power-supply lines, allowing several stages to be cascaded with a minimum of supply decoupling and stability problems.

The internal coupling capacitors are useful from 1 to 20 MHz, enabling the IC's to be direct-coupled. A three-stage amplifier with a gain of more than 1000 from 10 kHz to 10 MHz is shown in Fig. 5. Here additional external capacitors have been used to obtain the better lower frequency response. Still larger capacitors would allow operation into the sub-audio region, making this particular circuit well suited for oscilloscope preamplifiers and other wide-band, low-level amplifiers.

Comparators

Comparators are used to answer the question, "Which one is bigger?" when two inputs are applied. One input is often a reference voltage. In this mode, a comparator serves as a limit detector, an alarm, an analog-to-digital converter, or a sense amplifier for a computer's core memory. By using the *output* of a comparator as its own reference, a Schmitt trigger with controllable threshold voltage and hysteresis, both of which may be made zero, positive, or negative, is obtained. This configuration is of value in level detectors, alarms, tachometers, and anywhere else a snap-action output is required the instant a slowly changing input voltage crosses a critical value.

Fig. 5. A wide-band amplifier employing three CA3001 video-amplifier integrated circuits. Larger capacitors may be added to extend response to sub-audio range.

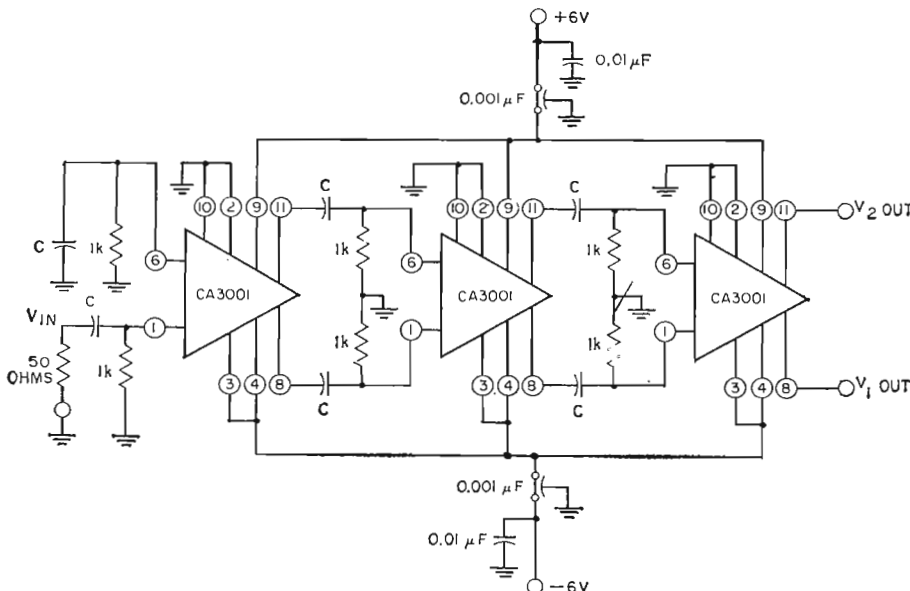

Fairchild's $\mu A710C$ (\$7.75) offers a comparator with a 1-millivolt resolution and a 40-nanosecond response time to changing inputs. It then converts its response into a digital signal compatible with digital integrated circuits. The voltage gain of the eight-pin TO-5 style IC is 1200 (62 dB). Linear input signals up to 5 volts may be accommodated. Schmitt-trigger operation is obtained by cross-coupling output and input with two resistors.

Another Fairchild unit, the $\mu A711$, is a dual version of the 710 with an added feature called a "strobe," which allows the output of each comparator to be independently enabled or interrogated. One important application is in magnetic-core sense amplifiers, but this IC will find use anywhere several comparators would normally be employed in related circuits. As with other Fairchild units, both premium military versions and limited-temperature commercial versions are available.

Complete I.F. Amplifiers & Discriminators

Certainly, one of the most impressive low-cost linear integrated available today is the RCA CA3013 (\$2.65). This ten-pin TO-5 style IC is a *complete* i.f. and audio section for a television 4.5-MHz or a high-quality FM 10.7-MHz i.f. strip. Inside the can are three self-limiting i.f. stages, a discriminator, a dual audio stage, and a regulated power supply. The twelve transistors and twelve diodes add up to eleven cents per active device, a price totally unmatched by discrete circuitry. (Refer to "TV Set Uses Integrated Circuit" in our June issue.—Editors)

There are three other similar IC's in the RCA line, two without the discriminator and audio stage (CA3011 and CA3012) and one with a higher voltage capability, the CA3014. These range in price from \$2.00 to \$3.65 each and lend themselves to many non-FM applications as well. Typical would be wide-band limiters and amplifiers often found in industrial instrumentation circuitry.

MOS Analog Gates

We can conclude our survey with some remarkable IC's using MOS (metal oxide semiconductor) technology. Called commutators, analog gates, or multiplexers, these IC's are both linear and digital at the same time.

The units serve as high-speed selector switches of the single-pole, multiple-throw variety. The MOS technology offers several unique advantages. Analog or varying input signals up to ten volts in amplitude of *either* polarity are switched in a d.c.-coupled manner with *zero* offset, a feat that no ordinary transistor, IC, or vacuum tube can ever hope to perform. Further, there is only insignificant coupling between the signal voltages and the input switching waveforms. Practically no input switching power is required, as the input impedance on the switching inputs is typically several thousand *megohms*.

Being brand-new devices, they are still expensive, but the analog gates are already finding wide use in industrial telemetry and sampling circuitry as well as in radar-image-processing circuitry.

The Fairchild $\mu M3700$ (\$62.50) is a representative sample of the dozen or so MOS analog gates now available. It may be used as a single-pole, five-position switch or as a single-pole, four-position switch with an all-channel blanking option. Any position can handle ± 10 volts of analog signal. "On" resistance is around 150 ohms with

(Continued on page 76)

High-Quality Square-Wave Generator

By C.J. ULRICK / Collins Radio Co.

This generator uses a novel design to produce perfect symmetry fast rise and fall time square waves covering the range from 20 to 20,000 Hz, using only a single-turn frequency control.

MOST simple square-wave generators have several drawbacks: their frequency range is limited, transition times may be sluggish, and the output wave-shape may not be symmetrical. The first objection can be overcome by using a wide-range relaxation oscillator with a fixed C and variable resistor. Such an oscillator can easily be adjusted through a 1000:1 range with a single control, and the audio band can be covered without using a range switch. The last two points can be resolved by employing a computer circuit—the triggered flip-flop. This circuit has perfect inherent symmetry and fast rise and fall times. In the test set to be described, the generator output can be varied from 20 Hz to 20 kHz because the oscillator runs between 40 Hz and 40 kHz and pulses from it trigger the flip-flop, causing it to divide the oscillator frequency in half while creating ideal square waves.

The components associated with $Q1$ and $Q2$ (see Fig. 1) form a relaxation oscillator and pulse generator. The series combination of $R1$ and $R2$ charges $C1$ to the firing voltage of $Q1$. Transistor $Q1$ draws current through $R5$, which turns on $Q2$. Regenerative action causes $Q2$ to hold $Q1$ on until $C1$ is completely discharged; then the cycle starts over again. The combination of $L1$ and $R4$ limits peak discharge currents to protect $Q1$.

The upper frequency limit is set by the time constant $R1C1$ and the lower limit by $(R1 + R2) (C1)$. Since the ratio of $R2$ to $R1$ is 1000:1, that is the frequency range of the oscillator. The value of $C1$ places the oscillator frequency in the desired part of the spectrum.

The flip-flop circuit of $Q3$ and $Q4$ is conventional except for the use of emitter bias rather than fixed bias.

To trigger the $Q3Q4$ circuit, the conducting transistor must be driven to cut-off for an instant, and then regenerative action will cause the circuit to change state. The trigger network consists of coupling capacitor $C3$, d.c. restoring diode $D2$, and trigger diodes $D1$ and $D3$. Triggering is aided by the virtual ground placed on the emitters by $C6$. The circuit works at a reduced power-supply voltage due to the drop across $R12$. If reliable triggering cannot be obtained, an increase in the value of $R12$ is called for, as this will make the circuit more sensitive to triggering.

The output terminal is isolated from the flip-flop by a complementary emitter follower formed by $Q5$ and $Q6$. This circuit is fairly novel in that the output is d.c.-coupled yet referenced to ground, that is, the square-wave output will always rise from ground to some positive level. This level is set by $R17$, which places a clamp voltage on the collector of $Q5$. Using this scheme, the generator displays a constant output impedance of less than 200 ohms, be-

sides the d.c.-coupling and zero-reference features. Maximum output is about 5 volts peak-to-peak.

Any convenient construction techniques can be used. If transformer power is employed, the supply should be zener-stabilized to hold the frequency stability. Leads associated with the flip-flop should be kept short and direct to eliminate the possibility that external noise will trigger this circuit to produce unwanted outputs.

Adjustment

The first step is to check the pulse generator. At point B in the circuit, narrow negative-going pulses should occur. If frequency control $R2$ is set at minimum resistance, these pulses will be at the highest frequency and thus will be more easily observed. Once they are acquired, rotate $R2$ to its maximum resistance to make sure the frequency is variable. If no pulses are apparent, then adjust bias level control $R7$ to obtain an output pulse. As soon as pulses are available, a square wave should show up at the output. If not, increase the value of $R12$.

Until square waves are obtained, do not probe any points inside the flip-flop, as some scope probes can load the circuit down and prevent operation.

As a last resort, the $Q3Q4$ circuit can be checked with a v.t.v.m. and a clip lead as follows. With $Q1$ unplugged, measure the collector voltages of $Q3$ and $Q4$ and connect the v.t.v.m. to the one that gives the lowest reading. This is the conducting side. Then short (Continued on page 82)

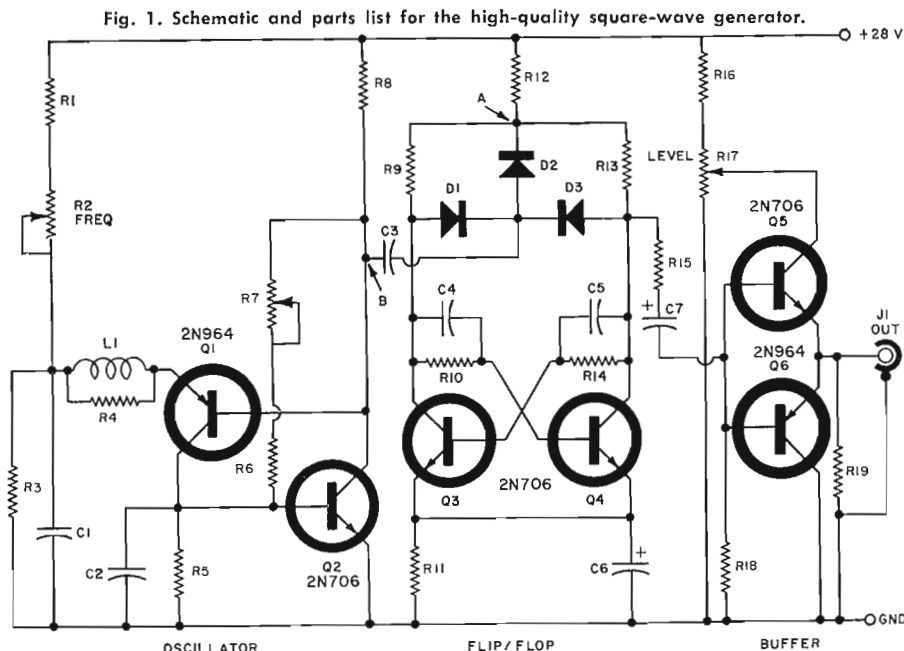

R1—1000 ohm, 1 W res.
R2—1 meg log taper pot
R3—1 meg resistor
R4—22 ohm resistor
R5, R8—10,000 ohm res.
R6—33,000 ohm resistor
R7—50,000 ohm pot
R9, R13—1800 ohm res.
R10, R14—3300 ohm res.
R11—100 ohm resistor

R12—560 ohm resistor
R15—8200 ohm resistor
R16—4700 ohm resistor
R17—2500 ohm pot
R18—39,000 ohm res.
R19—470 ohm resistor
All resistors 1/2 W unless otherwise noted

C1—.04 μ F \pm 5% mica capacitor
C2—220 pF capacitor
C3—1000 pF capacitor
C4, C5—500 pF capacitor
C6—1 μ F elect. capacitor
C7—10 μ F elect. capacitor
L1—4.7 μ H coil
D1, D2, D3—1N270
Q1, Q6—2N964
Q2, Q3, Q4, Q5—2N706

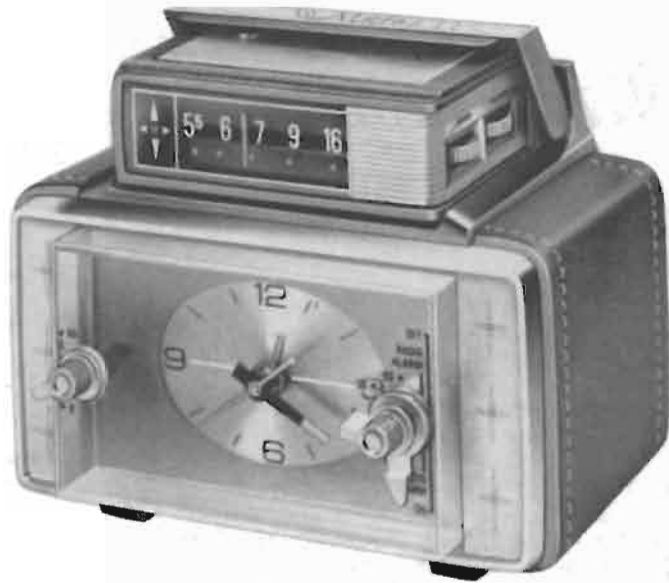

Fig. 1. The new IC radio, shown here atop its clock-timer recharger, is powered by a 3-cell, 3.75-V rechargeable nickel-cadmium battery.

World's First Single-Chip Integrated-Circuit Radio

By J.A. CACCIOLA and E.Q. CARR
Radio Receiver Dept., General Electric Co.

Technical details on first mass-produced AM radio using a single IC to replace all active components in circuit. All 125 dB of r.f. and a.f. gain required is packed into 35- by 40-mil silicon chip. High reliability permits 3-year warranty.

THE new G-E P1740 micro-sized receiver (Fig. 1) is the world's first mass-production AM radio in which a single integrated circuit replaces all the discrete transistors used in conventional portable radios. This is technically significant because all 125 dB of r.f. and audio power gain is packed into a 0.035 by 0.040-inch silicon chip (Fig. 2) about the size of one audio amplifier transistor. Consumers benefit from IC component reliability as demonstrated by the 3-year warranty on the radio. The portable set is powered by a rechargeable nickel-cadmium battery which is also covered by this same warranty.

Virtually everyone is expecting something different from these incredible little chips. Stylists are anxious to take advantage of small size; engineers want to explore new design concepts; production men think they may answer some production-line problems; and manufacturers generally expect high quality while improving cost control. R.C. Wilson, General Manager of G-E's Consumer Electronics Div. states "... it seems clear that microcircuits will have a major impact in shaping our industry."

Low cost, the pivotal factor in moving linear IC monolithics into consumer applications from high-reliability military, space, and industrial computers, results from three major steps:

1. Applying the same highly mechanized assembly methods responsible for the low-cost plastic encapsulated transistors already in many products.
2. Production control of island diffusion and epitaxial techniques, the more sophisticated semiconductor processes not used in many digital circuits but necessary for linear r.f. and audio bipolar circuits in the same chip.
3. Development of an inexpensive package capable of handling one watt or more of internal power dissipation.

Confident of the effectiveness of this particular attack on the cost problem, G.B. Farnsworth, Manager of Marketing, G-E Semiconductor Products Dept., has announced that 80-cent plastic-packaged circuits would be generally available in quantity during 1967 and that the prices could go below 50 cents each in production quantities.

Inside the IC Black Box

AM radios are a definite challenge to microcircuit de-

Fig. 2. A single silicon integrated-circuit wafer in process contains nearly 500 circuit chips, each measuring 35 by 40 mils. After dicing, 15 terminal connections are made to each of the circuit chips.

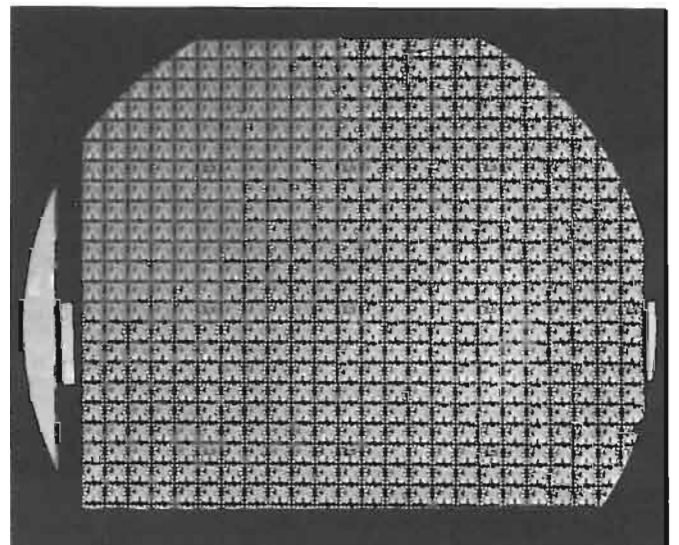

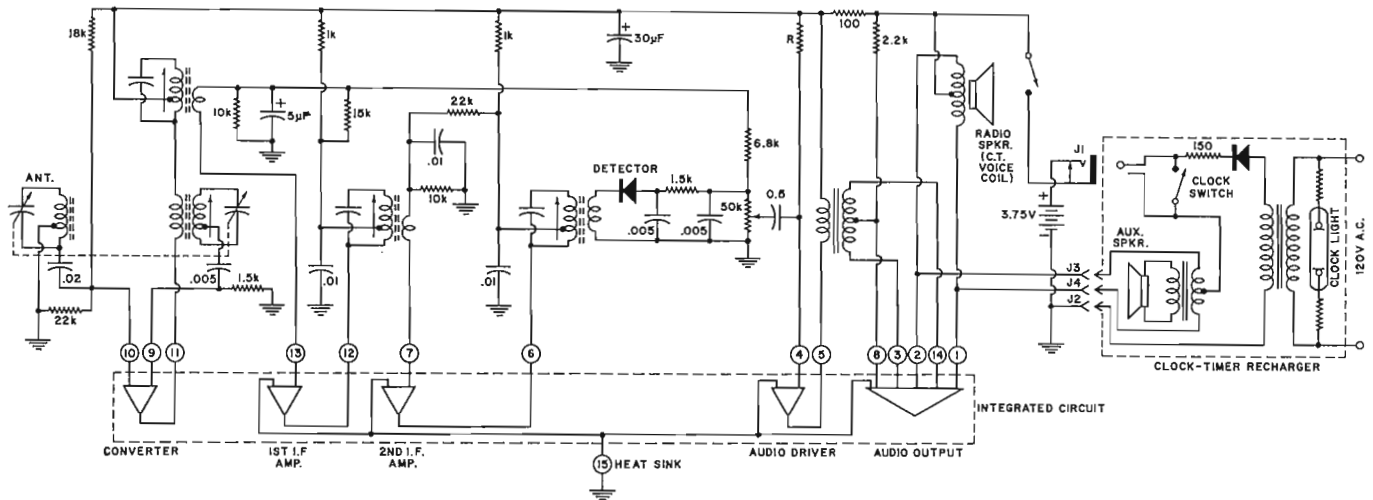

Fig. 3. Schematic of the IC radio. Outboard transformers and coils are used along with the outboard detector circuit. When the radio is plugged into its recharger, the battery is connected to the charging supply and an auxiliary speaker is hooked in.

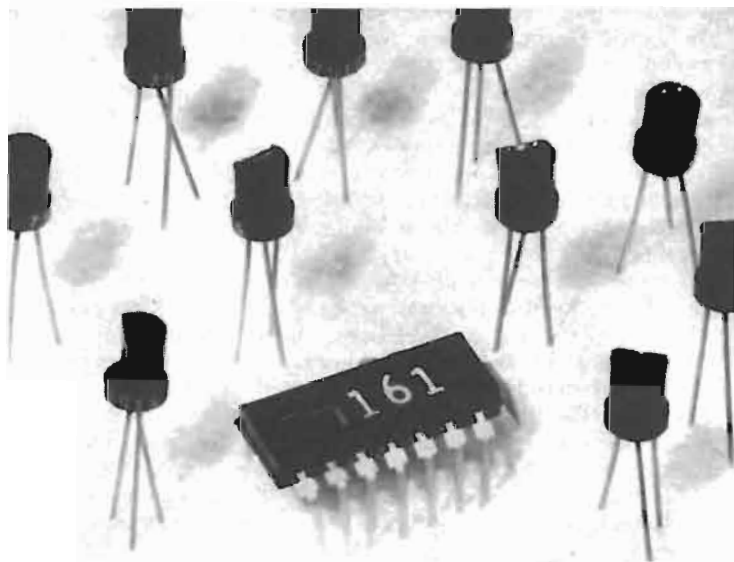

Fig. 4. A flat plastic package with 7 leads on each side and an extra heat-sink lead is used to house the IC. The highly mechanized production line that turns out these packages is an outgrowth of work on plastic-packaged silicon transistors shown.

signers—the ground rules on component values and component costs are all different. For example, there is currently no useful inductances that can be made in a monolithic circuit for the 455- to 1620-kHz frequency range. While resistors of reasonably high value can be made, a 75,000-ohm resistor can cost 5 to 10 times more than a signal transistor and an oxide capacitor of 5 pF takes up the same chip area as the transistor.

There are other design constraints as well, such as: 10% to 30% absolute tolerances and large temperature coefficients on resistors; 2:1 spread on transistor *betas* in a given production run; and the presence of small, but often troublesome, capacitive interconnections between elements in the monolithic structure.

With those constraints, why bother trying? Because in the long run, IC use will improve quality, performance, and dependability without increasing cost.

Besides, the design picture is not all that bleak. On the positive side of the ledger, monolithic integrated circuits have the following advantages:

1. Transistors and diodes actually require less silicon than discrete devices.
2. Elements can have virtually identical characteristics when placed side by side in the same circuit chip.
3. The ratio of the resistance values for a number of

similar resistors diffused in the chip can be kept as low as 1% even though the absolute values have large tolerances. Furthermore, the resistors track accurately over a wide temperature range.

4. There is excellent thermal coupling between the components in a single chip.

A.F. Petrie in a companion article which will appear in next month's issue, shows how artful contriving with monolithic circuit characteristics permits a high-performance 1-watt audio amplifier design. But for now, let's see what the first IC radio looks like.

Integrated-Circuit Radio Design

Schematically, the P1740 radio is not much different from many ordinary transistor radios, except for the fact that a good many of the components are located in the IC and that a battery charger is used. See Fig. 3. From a technician's standpoint, this is especially fortunate since voltage test points, current ratings, etc., are similar. There are, however, some subtle differences. Notice, for example, that the first i.f. amplifier has only two active terminals and a third terminal which is not available as a separate test point. Of the external resistors, *R*, a current-source bias resistor for the audio driver, is the only component which may be of different value from production lot to lot.

The IC package is a high-pressure transfer-molded plastic encapsulation (Fig. 4). All 14 connections, seven on each side, are used in the radio in addition to the 15th lead from the end of the package which serves as a com-

Fig. 5. Partly assembled chassis for IC radio. Outboard components are all standard types. The integrated circuit itself may be seen near bottom left, designated by "IC 161".

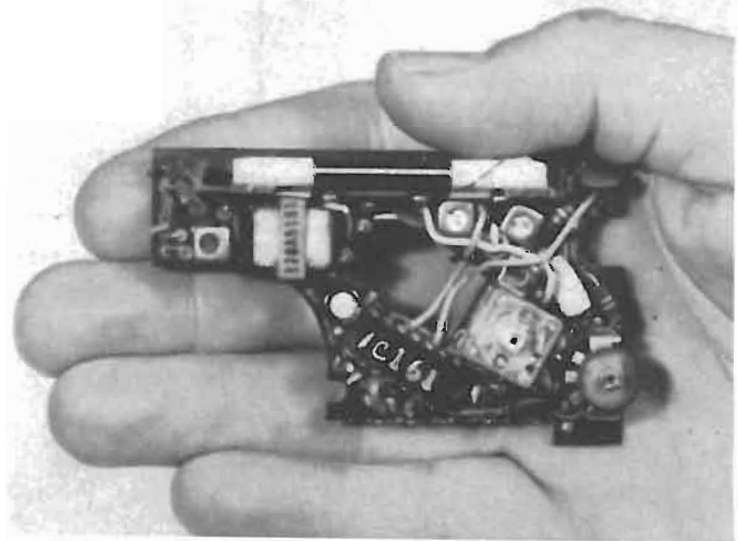

Sensitivity	300 μ V/meter (at 15 mW output)
Image Ratio	1200:1
Frequency Response	180 to 2500 Hz (at -6 dB)
Bandwidth	(Δf @ -6 dB) 5.5 kHz
Adjacent-Channel Attenuation	$f_o \pm 10$ kHz -30X $f_o \pm 20$ kHz -200X
Second I.F. Whistle	Below 20%
A.V.C.	Output changes 10 dB for input change of 35 dB
Maximum Power Output	140 mW
Current Drain (min. volume)	8 to 9 mA
Average Playing Time Before Recharge	8 to 12 hours

Table 1. Performance characteristics of the new IC radio.

mon ground, shield, and heat sink. Normal dip-solder techniques make connections to the receiver printed-circuit board as illustrated in a partially assembled radio (Fig. 5).

The rechargeable battery has an 8 to 12 hour average operating time between overnight recharge cycles. Operation while plugged into the charger base is enhanced by a larger speaker contained in either the straight recharger unit or in a clock-timer recharger which is also available. Clock-timer operation is identical to the usual clock radio with the additional advantage of containing a removable pocket-sized portable radio. Furthermore, the recharge feature provides a full three-year battery life without ever opening the radio.

Obviously, many standard parts including resistors, electrolytics, i.f. transformers, an oscillator transformer, and an audio driver transformer, are used.

Servicing, if necessary, beyond the warranty period will pose no unusual problems for competent technicians because the receiver is a straight single-conversion superheterodyne with a 455-kHz i.f. Performance data compiled in Table 1 should be reassuring on that score as well. If it is ever necessary to replace the IC, it will be available at a price of about \$6.00.

Why an IC Radio Now?

Applying IC functions to popular-priced AM radios has many advantages. The matching of transistors in the class-B audio output stage allows performance that could be achieved only by taking adjacent transistor pairs from a full wafer of ordinary silicon audio devices. But that would fall short of monolithic circuit performance since the V_{BE} tracking of output transistors with temperature is not usually duplicated.

Fig. 6. An "ideal" IC radio with six terminals.

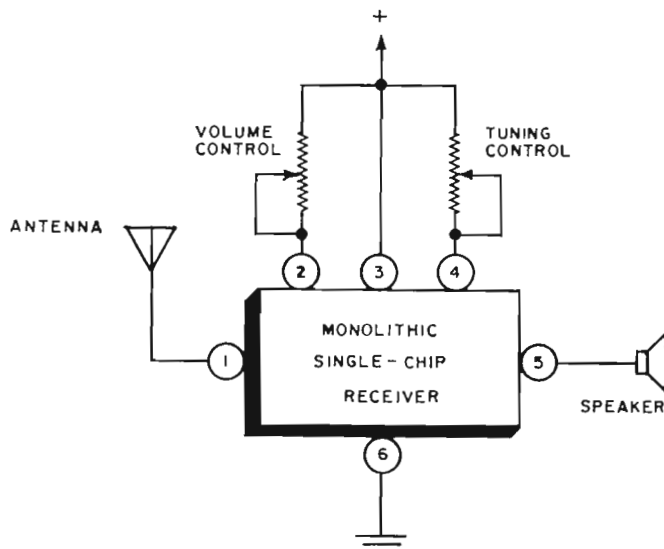

The tight thermal coupling of a monolithic IC cannot be matched using discrete transistors even by mounting them on a common heat sink. In addition, discrete devices do not permit a simple geometric scale for bias in a transistor voltage stabilizer which is easily contained in the monolithic IC and also thermally coupled to the output transistors.

An audio amplifier design of superior characteristics is, therefore, a natural result of IC use. What is more, it is possible to optimize the transistor emitter-base periphery for necessary *beta* linearity at high currents. With discrete transistors, despite the many thousands of different devices that are available, finding the optimum audio output transistor is not an easy job.

The Future of IC Radios

A complete radio, without external components, could probably be built on a single piece of silicon, but the performance would probably leave much to be desired. There are intriguing problems to solve in signal sensitivity, signal-to-noise ratio, power supply, tuning and volume controls, antenna, and speaker. The closest realization of such a radio would have six terminals (Fig. 6), but right now the practical compromises which would be necessary in tuning, selectivity, and signal-to-noise ratio, would place the performance below that of an ordinary low-cost transistor receiver. With *present* limitations on integrated-circuit production techniques, it is possible to get greater cost/value performance using simple bobbin-wound cup-core inductors in *LC* tuned stages. Thus, the final design chosen uses a single silicon chip with external *LC* tuned circuits.

Certainly there are other functional approaches to tuned circuits and even to the basic receiver operation. More than 40 years of modern receiver design have, however, hinged on the use of *LC* tuned circuits in single- or double-conversion superheterodyne designs. Integrated circuits may alter designs in the future, but this is by no means a certainty.

Present engineering work on precision frequency band-pass control with IC techniques is concerned with the use of *RC* frequency-selective feedback, negative-impedance converters, and "Q" multiplication. Specific solutions to these designs have encountered problems of supply voltage sensitivity, temperature sensitivity, limited signal range, difficulty in adjusting to frequency tolerances, and instability of elements with time, humidity, and other aging effects.

While none of these problems is insurmountable, the solutions for consumer receivers appear to be too complicated or difficult to be economically feasible.

Getting the *L* and the *C* out of radios has been achieved with mechanically resonant structures; usually a beam or plate of small dimensions driven into a resonant condition electrostatically, thermally, or magnetically. One successful solution, sometimes used in communications gear, involves piezo-ceramic structures. Cost is the main deterrent to consumer applications.

Another form of mechanical filter proposed is a small resonant beam of gold ingeniously fabricated as an electrode in a field-effect transistor on a silicon chip. The major problems here appear to be that beam dimensions, tolerances, and production control are not easily matched to the necessary bandwidth and frequency requirements of a superheterodyne receiver. Temperature and voltage sensitivity as well as long-term stability data have not become generally available for an assessment of this filter method.

Breakthroughs in any of the foregoing areas could trigger exciting technical innovations in radio design. Many tools are at hand and in various stages of development. Whatever techniques are used, however, the integrated circuit is sure to play a most important role. ▲

PART 3. PERFORMANCE OF PRACTICAL CIRCUITS

Designing Silicon-Transistor Hi-Fi Amplifiers

General considerations for conservative design using readily available silicon power transistors. Practical circuits of 10-, 25-, and 70-watt amplifiers and their performance are given.

By R.D. GOLD and J.C. SONDERMEYER
RCA Electronic Components & Devices

IN addition to the consideration that must be given to the achievement of performance objectives and the selection of the optimum circuit configuration (discussed in the previous two parts of this series), the circuit designer must also take steps to insure reliable operation of the audio amplifier under varying conditions of signal level, frequency, ambient temperature, load impedance, line voltage, and other factors which may subject the transistors to either transient or steady-state high stress levels. Some of these steps are relatively straightforward. For example, it is necessary to insure that the power dissipation ratings are not exceeded at high line voltage and under worst-case signal conditions. For class-A amplifiers, the maximum power dissipation occurs at zero signal. For an ideal class-B push-pull stage, maximum power dissipation occurs when the drive signal is 64 percent of that required for maximum output power. The corresponding output power for this condition occurs at 42 percent of the maximum output power, and the dissipation in each transistor is 20 percent of the maximum power output. Also, for class-AB transformer-coupled amplifiers, the appropriate transistor breakdown-voltage rating must be greater than twice the d.c. collector voltage that is employed.

Thermal Stability Requirements

One serious problem facing the design engineer, not only in the quasi-complementary circuit but in all the circuits thus far discussed, is the ability to design a circuit which is thermally stable at all temperatures to which the amplifier might be exposed. Ideally, the quiescent current of an output stage should remain constant at all temperatures of interest. At low current levels however, the base-to-emitter voltage (V_{BE}) of a transistor decreases with increases in the junction temperature for a given collector current (I_C). If V_{BE} is held constant, then I_C will increase as the temperature rises. This behavior may lead to thermal runaway.

The effect of increasing temperature on collector current can be reduced by the use of an emitter resistor which will provide some local d.c. feedback. At high signal levels, the over-all saturation voltage of the device will be increased because of the voltage drop across this resistor. One solution to the saturation-voltage problem is to bypass the emitter resistor with a capacitor. In high-power amplifiers, however, the emitter resistors employed usually have a value of about 1 ohm, and the size of the capacitor required to bypass the emitter adequately at all frequencies of interest makes this approach economically impractical. A more practical solution is to increase the value of the emitter resistor and shunt it with a diode. With this technique, sufficient degeneration is provided to improve circuit stability, but the maximum voltage drop across the

emitter resistor is limited to the forward voltage drop of the diode.

Thermal stability can be further improved by the addition of devices such as thermistors or bias diodes, the characteristics of which are such that they will tend to reduce the base drive voltage of the output transistor as temperatures rise. When these types of devices are used, it is possible to reduce or even eliminate emitter networks completely and thereby to reduce substantially the circuit losses at high power levels. It is interesting to note that a simple emitter diode itself will provide some improvement in circuit stability. The static resistance of a diode is fairly high at low currents (about 30 ohms at 20 milliamperes for a 1N1612). A disadvantage of this technique is that the forward voltage drop of this diode decreases with increasing temperature and, therefore, reduces the stabilizing effects of the high dynamic resistance.

It should be noted that at high current levels, the base-to-emitter voltage of silicon transistors increases with a rise in the junction temperature. This characteristic is the result of the increase in the small base resistance that is produced by the rise in temperature. The increase in base resistance with temperature has two beneficial effects: First, it helps to stabilize the transistor against thermal runaway because higher temperatures now require an increase in V_{BE} to cause an increase in I_C . Second, the increased resistance causes a portion of the transfer characteristic to be linear. A lower distortion is therefore possible at high temperatures.

The quasi-complementary amplifier shown in Fig. 1 incorporates the stabilization techniques just described. A

Fig. 1. Quasi-complementary amplifier with compensating diodes.

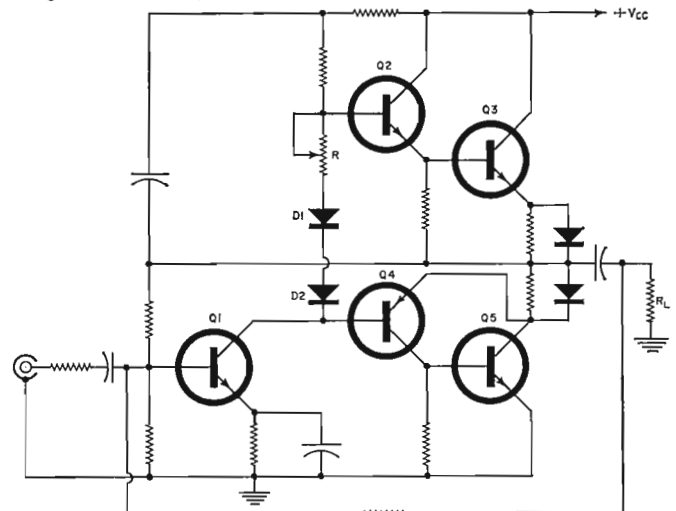

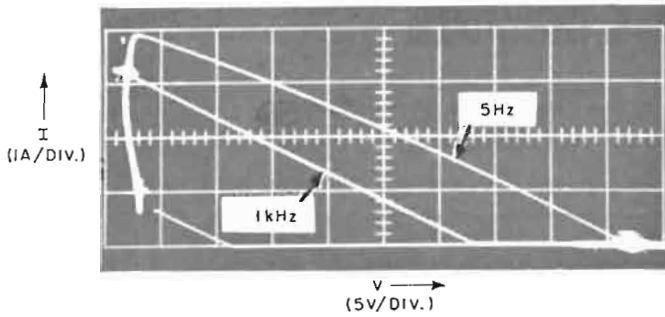

Fig. 2. Note load-line shift at very low operating frequency.

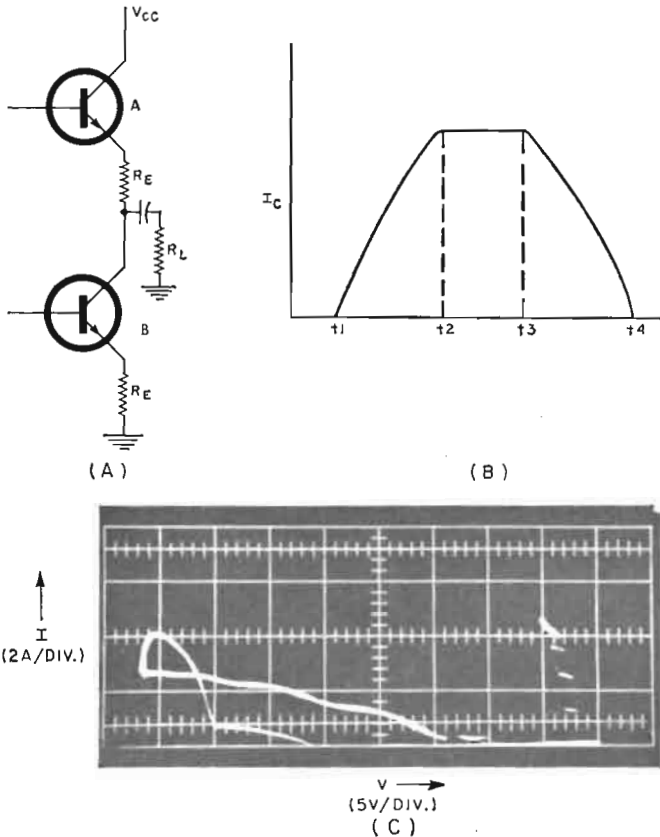

Fig. 3. (A) Output circuit which is overdriven. (B) Transistor A collector-current waveform. (C) Load line of circuit shown at operating frequency of 100 kHz and power output of 30 watts.

resistor-diode network is used in the emitter of transistor Q3, and another such network is used in the collector of transistor Q5.

Previous discussion regarding the *p-n-p* driver and *n-p-n* output combination (Q3 and Q5) revealed that the collector of the output device becomes the "effective" emitter of the high-gain, high-power *p-n-p* equivalent, and *vice versa*. Therefore, in order to provide maximum operating-point stability, the diode-resistor network should be in the "effective" emitter of the *p-n-p* equivalent. Most quasi-complementary circuits employ the stabilization resistor in the emitter of the lower output transistor and thus do not improve the operating-point stability of the over-all circuit. The resistor, however, does provide some protection against thermal runaway of the lower output transistor. Such protection may be necessary unless it is provided by other means.

The circuit shown in Fig. 1 is biased for class-AB operation by the voltage obtained from the forward drop of two diodes, D1 and D2, plus the voltage drop across potentiometer R, which affords a slight adjustment in the value of the quiescent current. The current necessary to provide this voltage reference is the collector current of

driver transistor Q1. The diodes may be thermally connected to the heat sink of the output transistors so that thermal feedback will be provided to further improve thermal stability. Because the forward voltage of the reference diodes decreases with increasing temperature, these diodes effectively compensate for the decreasing V_{BE} of the output transistors by reducing the external bias applied. In this way, the quiescent current of the output stage can be held relatively constant over a wide range of operating temperatures.

The value of the transistor operating parameters that affect thermal stability can be calculated to insure freedom from thermal runaway. In these calculations it should be realized that the temperature-dependent collector leakage-current limit specified by the transistor manufacturer actually consists of two components. One is related directly to the collector junction saturation current and is a strong function of temperature. In silicon transistors, this component is approximately doubled with each 7°C rise in junction temperature. At room temperature, however, it is on the order of only a few nanoamperes, so that a rise in case temperature of 140°C will cause the saturation current to rise only a few milliamperes.

The other component of collector leakage current is a surface leakage which is relatively independent of temperature. In fact, this leakage component may decrease as the temperature increases. The value of total leakage current (I_{CER}) specified by the transistor manufacturer is the sum of these two components. If the specified value is on the order of a few milliamperes, it will remain substantially constant with temperature. For example, in the published data for the RCA-40363, I_{CER} is given as 0.5 milliamperes (maximum) at $T_c = 150^\circ\text{C}$. The transistor is, therefore, quite stable thermally with respect to any changes that might occur in the amount of leakage current.

Effects of Large Phase Shifts

The frequency-response characteristic is an important factor with respect to the ability of the amplifier to withstand unusually severe electrical stress conditions. For example, under certain conditions of input signal amplitude and frequency, the amplifier may break into high-frequency oscillations which can lead to destruction of the output transistors, the drivers, or both. This condition is particularly a problem in transformer-coupled amplifiers because the characteristics of transformers depart from the ideal at both low and high frequencies. The departure occurs at low frequencies because the transformer inductive reactance decreases and, at high frequencies because the effects of leakage inductance and of transformer wind-

Fig. 4. Push-pull power amplifier with short-circuit protection.

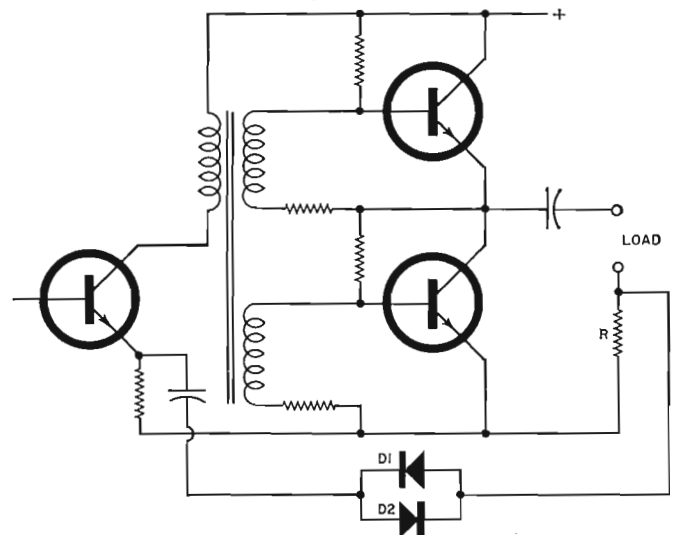

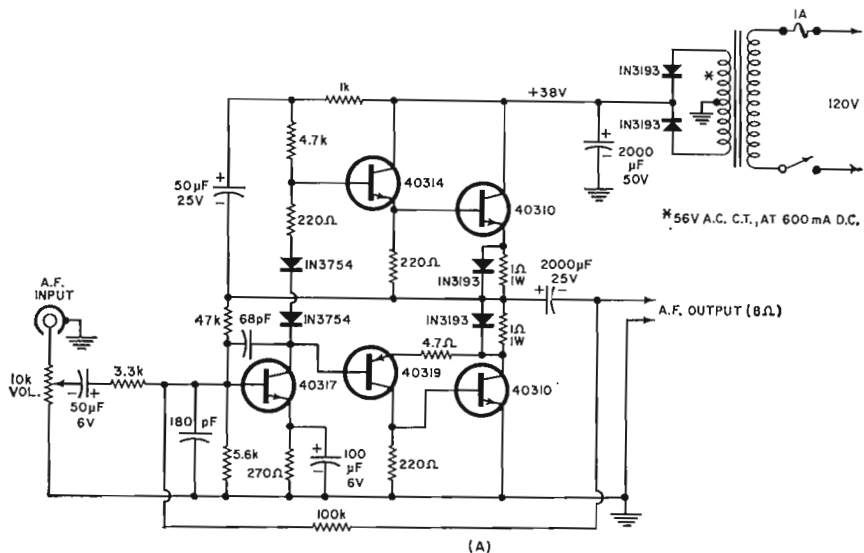
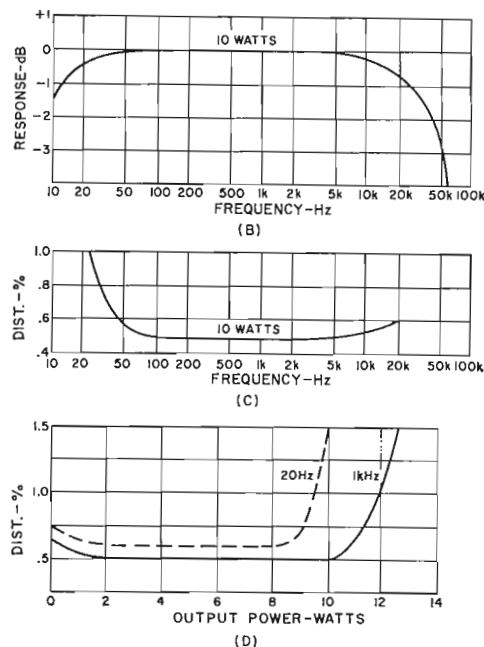

Fig. 5. Circuit diagram and performance of 10-watt amplifier.



ing capacitance become appreciable. At both frequency extremes, the effect is to introduce a phase shift between input and output voltage.

Negative feedback is used almost universally in audio amplifiers, and the voltage coupled back to the input by the feedback loop may cause the amplifier to be potentially unstable at some frequencies, if the additional phase shift is sufficient to make the feedback positive. Similar effects can occur in transformerless amplifiers because reactive elements, such as coupling and bypass capacitors, transistor junction capacitance, stray wiring capacitance, and inductance of the loudspeaker voice coil, are always present. The values of some of the reactive elements (e.g., transistor junction capacitance and transformer inductance as the core nears saturation) are functions of the signal level, and coupling through wiring capacitance and unavoidable ground loops may also vary with the signal level. As a result, an amplifier which is stable under normal listening levels may break into oscillations when subjected to high-level signal transients.

A large phase shift is not only a potential source of amplifier instability, but also results in additional transistor power dissipation and increases the susceptibility of the transistor to forward-bias second-breakdown failures. The effects of large signal phase shifts at low frequencies are illustrated in Fig. 2, which compares the load-line characteristics of a transistor in a class-AB push-pull circuit, similar to that shown in Fig. 1, for signal frequencies of 1000

Hz and of 5 Hz. The phase shift is caused primarily by the output capacitor. In both cases the amplifier is driven very hard into saturation by a 5-volt input signal. The increased dissipation at 5 Hz compared to that obtained at 1000 Hz results from simultaneous high-current and high-voltage operation. The transistor is required to handle safely a current of 0.75 ampere at a collector voltage of 40 volts for an equivalent pulse duration of about 10 milliseconds; it must be free from second breakdown under these conditions of operation.

Excessive Drive Levels

Simultaneous high-current and high-voltage operation may also occur in class-B amplifiers at high frequencies when the amplifier is overdriven to the point where the output signals are clipped. For example, assume that the input signal applied to the series-output push-pull circuit shown in Fig. 3A is large enough to drive the transistors into both saturation and cut-off. During a portion of the input

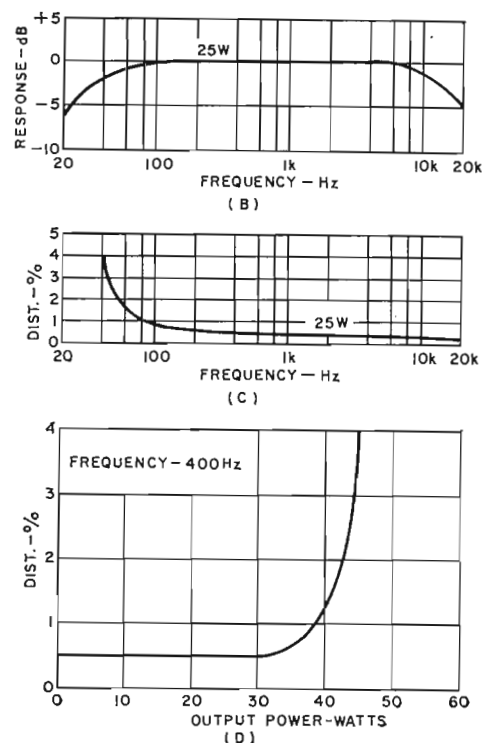
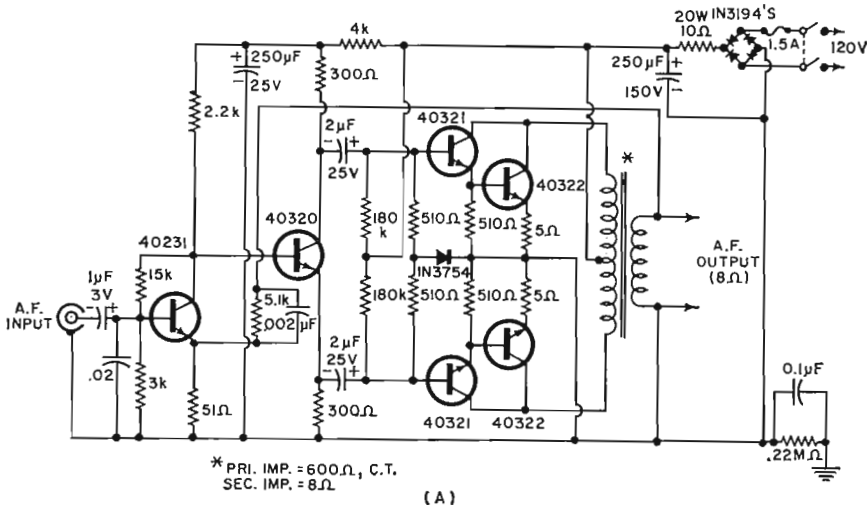

Fig. 6. A 25-watt a.c./d.c. transformer-coupled amplifier.



cycle, therefore, transistor A will be driven into saturation, and transistor B will be cut off. Fig. 3B shows the collector-current waveform for transistor A under these conditions.

During the interval from t_2 to t_3 , transistor A operates in the saturation region, and the output voltage is clipped. The effective negative feedback is then reduced because the output voltage does not follow the sinusoidal input signal. Transistor A, therefore, will be driven even further into saturation by the unattenuated input signal. When transistor B starts to conduct, transistor A cannot be turned off immediately because the excessive drive has resulted in a large storage time. As a result, transistor B is required to support essentially the full supply voltage (less only the saturation voltage of transistor A and the voltage drop across the emitter resistors, if used), as its current is increased by the drive signal. For this condition, a large input signal is required when the frequency is high enough so that the storage time is greater than one-quarter cycle.

Fig. 3C shows the type of load line obtained under such conditions. The duration of the high-current, high-voltage condition is usually short enough so that forward-bias second breakdown does not occur. For example, the load line shown is for a 2N3878 transistor operated at a frequency of 100 kHz; no second breakdown failure occurred.

Transistor A in Fig. 3A is also subject to forward-bias second breakdown if the d.c. supply voltage and a large input signal are applied simultaneously, because of the charging current through the output coupling capacitor.

If the load of a transformer-coupled amplifier is disconnected during operation, the transistor then sees an inductive load (the transformer primary inductance). When the transistor is turned off, reverse-bias second breakdown may occur. Direct- or capacitive-coupled circuits, on the other hand, are quite stable with the load removed.

If the amplifier high-frequency response is limited by the high-frequency capability of the output transistors, then the driver transistors may be unduly stressed under high-frequency, high-drive conditions. This stress is produced because the reduction in output voltage, as amplifier gain decreases, results in a smaller negative feedback voltage. The effective over-all amplifier gain is therefore increased, thereby causing the current in the driver transistors to increase. At sufficiently high frequencies, failure may then result because the drivers become overloaded.

This potential cause of failure can be avoided by the

Fig. 7. A 70-watt direct-coupled audio power amplifier.

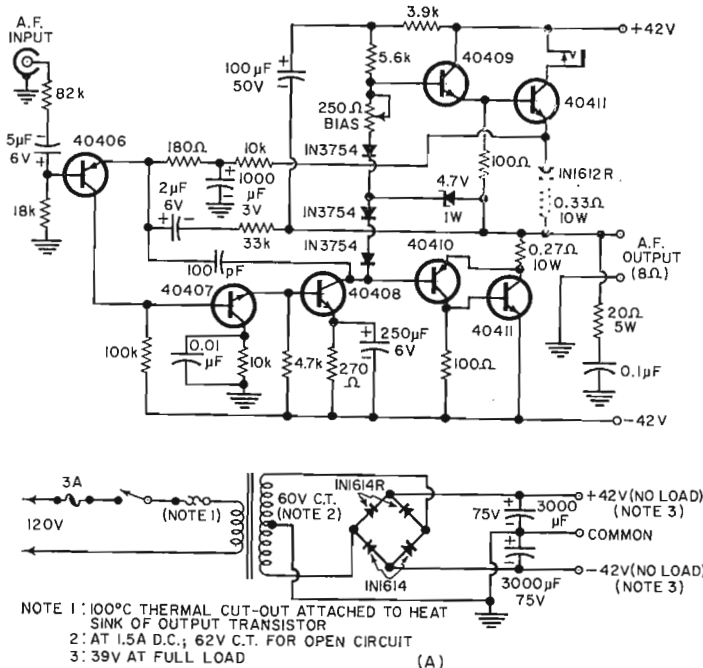

deliberate introduction of a frequency roll-off at the input, or by the use of high-frequency output transistors. The 2N3878, which has a typical gain-bandwidth product of 100 MHz, is well suited as an output for very wide band amplifiers. This transistor has been used in a low-distortion amplifier to obtain a frequency response which is down only 1 dB at 15 Hz and at 200 kHz at 20 watts output.

Short-Circuit Protection

Another important consideration in the design of high-power audio amplifiers is the ability of the circuit to withstand short-circuit conditions. When the output terminals of an amplifier are shorted, the feedback becomes ineffective, and the open-loop gain is such that overdrive conditions result in disastrously high currents and excessive dissipation in both driver and output stages. Generally, before the output fuse can blow, the transistors are destroyed. Obviously, some form of short-circuit protection is necessary.

One such technique is shown in Fig. 4. A current-sampling resistor R is placed in the ground leg of the load. If any condition (including a short) exists such that higher-than-normal load current flows, diodes $D1$ and $D2$ conduct on alternate half cycles and, thereby, provide a high negative feedback which effectively reduces the drive of the amplifier; however, this feedback should not exceed the stability margin of the amplifier. Notice that this technique does not in any way effect the normal operation.

10-Watt, Class-AB Audio Amplifier

The advantages of using silicon power transistors in the driver and output stages of high-power audio amplifiers are shown by the typical performance of three practical circuits designed to operate at widely different power-output levels (10 watts, 25 watts, and 70 watts). The performance data shows that silicon transistors can be used to develop high levels of audio output power in circuits that exhibit the wide frequency response, high sensitivity, and low distortion levels required in high-quality audio systems. Moreover, because of the high-tempera- (Continued on page 80)

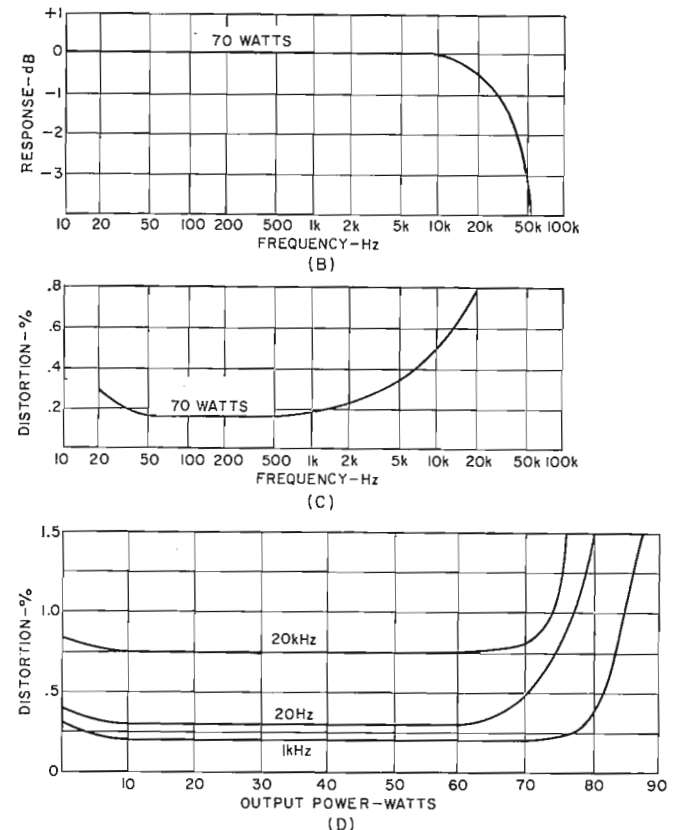

How To Save Up To \$279 On A Guitar & Amplifier

Just Build One Of These Famous
HARMONY-By-HEATHKIT® Guitars
 In An Evening - No Woodworking
 ... And Build The New **HEATHKIT®**
 Guitar Amplifier In 8-10 Hours!



A \$300 Value!
 Only
\$129⁹⁵



B \$329.50 Value!
 Only
\$219⁹⁵



C \$158.50 Value!
 Only
\$119⁹⁵



D \$145 Value!
 Only
\$99⁹⁵

No Special Skills Or Knowledge Needed
 Now you can save up to \$109.55 on a famous American-made Harmony electric guitar — plus another \$170 on the new Heathkit transistor guitar amplifier — by assembling them yourself the easy Heathkit way.

And all you need are some ordinary tools and a few spare-time hours . . . no technical skills or knowledge are required. The famous Heathkit instructions (so simple a child can understand) and giant pictorials guide you every step of the way. Nothing is left to chance.

You'll have your guitar kit finished in one evening. To give you a head start, all the wood parts are preassembled, finished and buffed at the Harmony factory. You just mount the trim parts, pickups and controls in the pre-drilled holes and install the strings. All woodwork and mechanical parts guaranteed a full year.

Each guitar kit includes a handsome chipboard carrying case with plush lining, instruction book, tuning record, pick, connecting cord, and a cushioned leather neck strap.

The guitar amplifier kit will probably take you a couple of evenings. Only one small circuit board to wire (don't worry about soldering, the Heathkit manual shows you exactly how), plus a few parts to mount on the chassis, and two speakers, controls and switches to install. The cabinet is already prebuilt and finished. It's easy fun.

Full Details FREE — Liberal Credit Terms
 Compare the features of each kit. For complete details, plus information on the convenient Heath Time-Payment plan send for the FREE Heathkit Catalog. Or better yet, use the coupon below to order your guitar and amplifier now!

A Deluxe Transistor Guitar Amplifier Kit . . . All The Features Guitarists Want Most. • 60 watts peak power — maximum power from Fail-Safe output circuit • Two channels — one for accompaniment, accordion, organ or mike, — the other for special effects with both variable reverb and tremolo • 2 inputs per channel • Two foot switches for hands-free control of tremolo & reverb • Two special design 12" heavy-duty speakers • Line bypass reversing switch for hum reduction • 28" W x 9" D x 19" H leather-textured black vinyl cabinet of 3/4" stock • Extruded aluminum front panel
Kit TA-16, 44 lbs... Save \$170 . . . Only \$129.95

B Deluxe Hollow Body Electric Guitar . . . Three Golden Tone Pickups . . . Flat Wound Strings • Double-cutaway style for easy fingering of all frets • Ultra-slim fingerboard—24 1/2" scale • Ultra-slim, "uniform-feel" neck with adjustable Torque-Lok reinforcing rod • 3 pickups with individually adjustable pole-pieces under each string for emphasis and balance • 3 silent switches select 7 pickup combinations • 6 controls for tone and volume •

Professional Bigsby vibrato tail-piece • Curly maple arched body with "F" holes — 2" rim — shaded cherry red • Engraved headpiece, matching pick guard
Kit TG-46, 17 lbs... Save \$109.55... Only \$219.95

C "Rocket" Hollow Body Electric Guitar . . . Two Golden Tone Pickups • Single cut-away style for easy fingering • Ultra-slim fingerboard . . . 24 1/2" scale for easy chording • Ultra-slim neck, Torque-Lok steel rod reinforced • 2 pickups with individually adjustable pole-pieces for each string • Silent switch selects 3 combinations of pickups • 4 controls for tone and volume • Harmony type "W" vibrato tailpiece • Laminated maple Ultra-thin arched body with "F" holes, 2" rim, shaded cherry red • White plastic pick guard
Kit TG-36, 16 lbs... Save \$38.55... Only \$119.95

D "Silhouette" Solid-Body Electric Guitar . . . Two Golden Tone Pickups . . . Modern Design • Modified double cutaway leaves 15 frets clear of body for playing comfort and ease • Ultra-slim fingerboard of black rosewood — 24 1/2" scale • Ultra-slim neck for "uniform feel" • Torque-Lok adjustable reinforcing rod • 2 pickups with individually adjustable pole-pieces under each string • 4 controls for tone and volume • Harmony type "W" vibrato tailpiece • 6-in-line tuning keys • Hardwood solid-body, 1 1/2" rim, shaded cherry red • Extra large pick guard
Kit TG-26, 13 lbs... Save \$45 Only \$99.95



FREE!

World's Largest
 Electronic Kit
 Catalog

108 pages describe these and over 250 kits you can build—stereo hi-fi color TV, electronic organs, radios, marine, home & hobby items. Mail coupon or write Heath Company, Benton Harbor, Michigan 49022.

Heath Company, Dept. 15-11
 Benton Harbor, Michigan 49022
 In Canada, Daystrom Ltd.

Please send FREE Heathkit Catalog

Enclosed is \$ _____, plus shipping.

Please send model (s) _____

Name _____

Address _____

City _____ State _____ Zip _____

Prices & specifications subject to change without notice.

TG-100



Now 9 New Kits From HEATH...

NEW! Deluxe Solid-State FM /FM Stereo Table Radio



Kit GR-36
\$69⁹⁵

Tuner and IF section same as used in deluxe Heathkit transistor stereo components. Other features include automatic switching to stereo; fixed AFC; adjustable phase for best stereo; two 5 1/4" PM speakers; clutched volume control for individual channel adjustment; compact 19" W x 6 1/2" D x 9 1/4" H size; preassembled, prealigned "front-end"; walnut cabinet; simple 10-hour assembly. 24 lbs.

NEW! Compact 2-Way 2 Speaker System With Acoustic Suspension Design

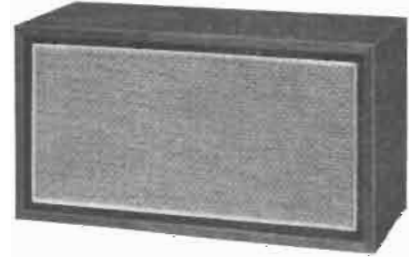

Kit AS-16
\$49⁹⁵

Handles 10 to 25 watts of program material. Features wide 45 to 20,000 Hz response; 8" acoustic suspension woofer with 6.8 oz. magnet; 3 1/2" tweeter with 4.8 oz. magnet; high frequency level control; 8 ohm impedance; 1500 Hz crossover frequency; assembled walnut veneer cabinet has scratch-proof clear vinyl covering for easy cleaning. Measures 10" H x 19" W x 8 1/2" D. Speakers are already mounted; just wire the crossover and connect cables — complete in one or two hours! 17 lbs.

NEW! Amateur Radio Single-Bander Transceivers ... New Features ... Choose 75, 40 or 20 Meters



Kit HW-12A
75-Meter
\$99⁹⁵

Now features upper or lower sideband operation on all models; new deluxe styling; more convenient control locations; 200 watts P.E.P. input; single knob tuning with 2 kHz dial calibration; new ALC input for use with external linear amplifiers; improved audio and AVC response; crystal filter type SSB generation; built-in S-meter, VOX, PTT and ALC; fixed or mobile operation. 15 lbs. Kit HW-22A, 40-meter.. \$104.95. HW-32A, 20-meter.. \$104.95

NEW! Deluxe Amateur Station Console ... 4 Separate Units In One!



Kit SB-630
\$74⁹⁵

Includes 24-hour clock, SWR meter, hybrid phone patch and an all-electronic 10-minute timer with audio/visual signaling in one compact unit. Matched in styling and performance with the famous Heath Deluxe SB-Series amateur radio equipment. Measures a compact 6" H x 10" W x 11 1/8" D. 9 lbs.

NEW Heathkit® /Magnetic® 1020 4-Track Stereo Recorder Kit



Kit AD-16
\$399⁵⁰
(less cabinet)

Save \$170 By Doing The Easy Assembly Yourself. Takes around 25 hours. Features solid-state circuitry; 4-track stereo or mono playback and record at 7 1/2 & 3 3/4 ips; sound-on-sound, sound-with-sound and echo capabilities; 3 separate motors; solenoid operation; die-cast top-plate, flywheel and capstan shaft housing; all push-button controls; automatic shut-off at end of reel; plus a host of other professional features. 45 lbs. Optional walnut base \$19.95, adapter ring for custom or cabinet installation \$4.75

Now Play In Minutes Instead Of Months ... Heathkit®/Thomas COLOR-GLO Organ



Kit GD-325B
\$394⁹⁰

Color-Glo Key Lights Show You the correct notes and chords . . . you play melody, harmony and bass notes instantly . . . even if you've never played an organ before! When you're finished, just flip a switch and the key lights disappear, leaving a beautiful spinet-organ. Includes 10 voices, repeat percussion, 13-note bass pedals, two 37-note keyboards, assembled walnut cabinet & bench and more. Fully transistorized. Builds in around 50 hours and you save up to \$150! 172 lbs.

Plus New FREE 1967 Catalog

NEW 12" Transistor Portable TV Kit

Kit GR-104
\$119⁹⁵



NEW Transistor Portable Phonograph Kit

Kit GD-16
\$39⁹⁵



First Kit With Integrated Circuit . . . replaces 39 parts! Unusually sensitive performance. Plays anywhere . . . runs on household 117 v. AC, any 12 v. battery, or optional rechargeable battery pack (\$39.95); preassembled, prealigned tuners; high gain IF strip; Gated AFC for steady, jitter-free pictures; assembles in only 10 hours. Cabinet measures 11 1/2" H x 15 3/4" W x 9 3/8" D. 23 lbs.

Worth At Least 50% More! And it sounds better. Assembles in just 1 to 2 hours . . . simply wire one small circuit board, mount the 4" x 6" speaker and plug in the preassembled changer . . . ideal beginner's kit. Features automatic mono play of all 4 speeds; dual Sapphire styli for LP's or 78's; 45 rpm adapter; olive and beige polyethylene over sturdy, preassembled cabinet. Operates on 117 v. AC. 23 lbs.

NEW Deluxe SB-301 Amateur Receiver Kit NEW Deluxe SB-401 Amateur Transmitter Kit



Kit SB-301
\$260⁰⁰
(less speaker)

New SB-301 receiver for 80 Thru 10 Meters with all crystals furnished, plus 15 to 15.5 MHz coverage for WWV; full RTTY capability; switch-selected ANL; front-panel switching for control of 6 and 2 meter plug-in converters; crystal-controlled front-end for same tuning on all bands; 1 kHz dial calibrations — 100 kHz per revolution. 23 lbs. Matching SB-401 transmitter, now with front-panel selection of independent or transceive operation . . . \$285.00

NEW 2-Watt Transistor Walkie-Talkie

Assembled GRS-65A
\$99⁹⁵



Completely Assembled. Features 2 watts of power for up to 6 mile range . . . up to 10 miles when working a 5-watt CB rig; \$20 rechargeable battery; 9 silicon transistor, 2 diode circuit; superhet receiver; adjustable squelch, ANL; aluminum case. 3 lbs. Optional 117 v. AC battery charger cord plus cigarette lighter cord \$9.95. Crystals extra @ \$1.99 each with order.

66-Watt Solid-State AM/FM/FM Stereo Receiver

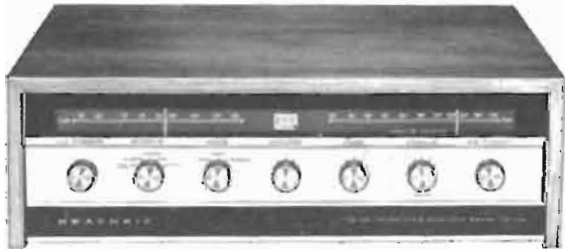

Just Add 2 Speakers For A Complete Stereo System. Boasts AM, FM and FM stereo tuning; 46 transistor, 17 diode circuit for cool, instant operation and natural transistor sound; 66 watts IHF music power (40 watts RMS) at ± 1 db from 15 to 30,000 Hz; automatic switching to stereo; preassembled & aligned "front-end" & AM-FM IF strip; walnut cabinet. 35 lbs.

Kit AR-13A
\$184⁰⁰

30-Watt Solid-State FM/FM Stereo Receiver

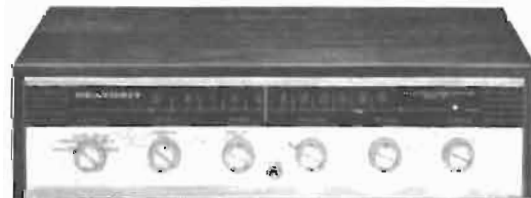

World's Best Buy In Stereo Receivers. Features 31 transistors, 10 diodes for cool, natural transistor sound; 20 watts RMS, 30 watts IHF music power @ ± 1 db, 15 to 50,000 Hz; wideband FM/FM stereo tuner; plus two pre-amplifiers; front panel stereo headphone jack; compact 3 7/8" H x 15 1/4" W x 12" D size. Custom mount it in a wall, or either Heath cabinets (walnut \$9.95, beige metal \$3.95). 16 lbs.

Kit AR-14
\$99⁹⁵
(less cabinet)



FREE!
World's Largest
Electronic Kit
Catalog!

Assembles more than 250 kits: stereo, hi-fi, color TV, amateur radio, shortwave, test, CB, marine, educational, home and hobby. Save up to 90% by doing the easy assembly yourself. Send coupon or write Heath Company, Benton Harbor, Michigan 49022.

HEATH COMPANY, Dept. 15-11
Benton Harbor, Michigan 49022
In Canada, Dastrom Ltd.

Enclosed is \$ _____, plus shipping.

Please send model (s) _____

Please send FREE 1967 Heathkit Catalog.

Name _____

Address _____

City _____

State _____

Zip _____

Prices & specifications subject to change without notice.

CL-261

CIRCLE NO. 111 ON READER SERVICE CARD

Diode Meter Protectors

By A. A. MANGIERI

How much protection is afforded by meter-shunting diodes and fuses? What is the effect on meter reading, accuracy?

DIODE meter protectors are an inexpensive means of guarding costly meters against damage. In particular, volt-ohm-milliammeters are most susceptible to damage if the range switch is inadvertently left on a current range when circuit voltages are being checked.

Can we merely connect the diode protector to the meter and then assume it is completely protected? Does the pro-

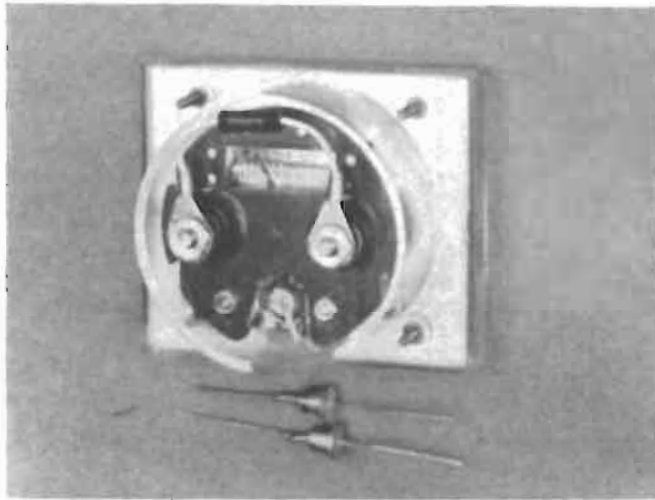
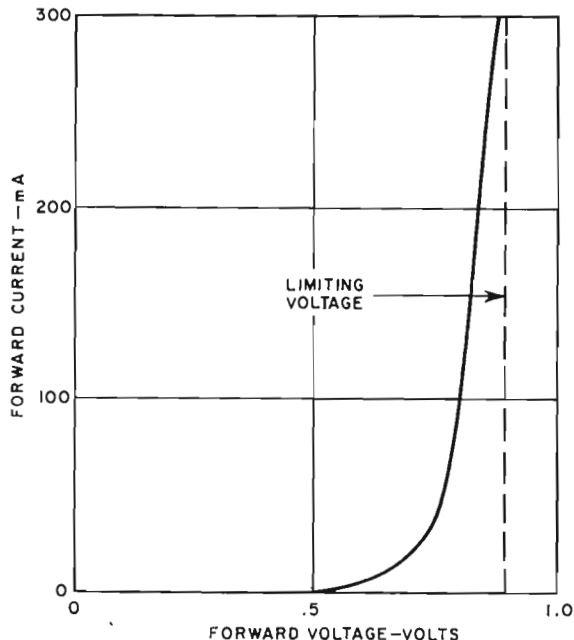

Fig. 1. Diode meter protector connects directly across meter terminals. Unit shown contains two diodes in one package. Silicon top-hat rectifiers shown below are also usable as effective meter protectors after selection by simple tests.

Fig. 2. Typical forward V-I characteristics of OMC7111 diode.



tection afforded depend on the v.o.m. circuit, the range-switch setting, and the meter characteristics? With the diode connected, is meter accuracy dependent on the d.c. voltage and current waveforms? These factors should be considered when using shunt diode protectors.

Diode Characteristics

Diode meter protectors, as shown in Fig. 1, are shunted directly across the meter terminals. Each device contains two silicon diodes connected in parallel and back-to-back, affording protection against overloads of either polarity. The meter is protected by the forward V-I characteristic of one diode, while the other diode, being reverse-biased, is inactive.

Fig. 2 shows the measured forward V-I characteristic of an Ohmite OMC7111 "Metersaver." As shown in the diagram, the diode can be approximated as a voltage limiter which operates at 900 millivolts at rated current.

Meter-protecting diodes have very low forward currents in the zero- to 300-millivolt region and very low reverse current leakage. Below 300 millivolts, the d.c. resistance is above 600,000 ohms. Because meter resistances are much lower, shunting the diode across the meter terminals introduces errors of only about .5% or less, depending upon the meter resistance. The OMC7111 has an absolute maximum and continuous forward-current rating of 300 milliamperes. The Lectrotech "Metergard" is rated at 1 A continuous and is surge-rated at 6 A for one cycle.

Meter Characteristics & Overload

Quality d.c. meters can withstand at least a 10× overload (ten times full-scale value) for one-half second and a 1.5× overload continuously. Many can tolerate double or even triple these overloads with no serious damage. Because meter construction varies, there is much uncertainty as to meter overload capability beyond the 10× momentary and 1.5× continuous overloads.

Table 1 lists the electrical characteristics of a number of panel meters up to one milliamperes full scale. Full-scale millivolts is obtained by multiplying full-scale current rating times the meter resistance. The method of calculating meter overload current multiplication factors is covered a little further on. These factors represent the overloads in the meter *with* diode protection and *not* the overload capabilities of the meter alone.

The first two instruments given in the table are representative of the high and moderate millivolt sensitivities found in the movements employed in most v.o.m.'s. The costlier low-resistance suspension type listed is found in meters of very low d.c. voltage drop that are used in transistor work.

The meter overload factor is found by dividing the diode-limiting voltage by the full-scale millivolt sensitivity of the meter. As an example, using 900 millivolts from Fig. 2, the calculation for the 50-microampere Simpson meter listed is 900 mV/250 mV or 3.6×. The maximum actual meter cur-

D.C. Range (Microamperes)	Simpson 1212			Knight 3½", 4½"			Triplet 320R (Band-Suspension Type)		
	Approximate Meter Ohms	Millivolts Full Scale	Overload Factor ^o	Approximate Meter Ohms	Millivolts Full Scale	Overload Factor ^o	Approximate Meter Ohms	Millivolts Full Scale	Overload Factor ^o
10	7500	75	12X
50	5000	250	3.6X	2000	100	9X	825	41	22X
100	2000	200	4.5X	1240	124	7.3X	360	36	25X
200	1000	200	4.5X	600	120	7.5X	156	31	29X
500	200	100	9X	40	20	45X
1 mA	46	46	20X	46	46	20X	12.5	12.5	72X

^oCalculations based on 900-millivolt diode-limiting voltage (see text).

Table 1. Characteristics and overload factors for various types of basic panel meters discussed by author.

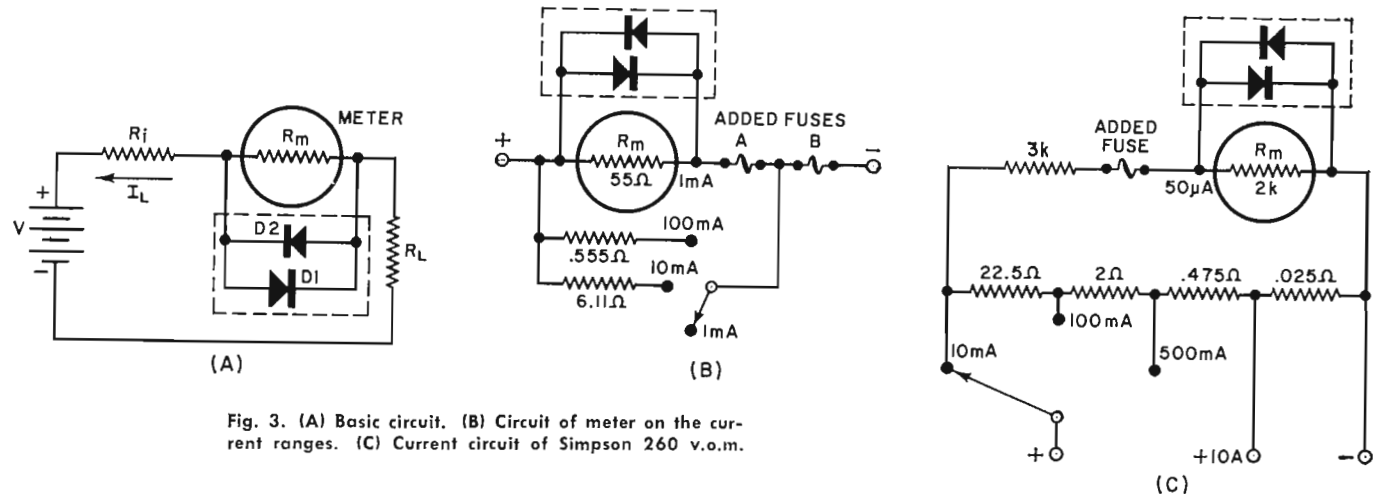

Fig. 3. (A) Basic circuit. (B) Circuit of meter on the current ranges. (C) Current circuit of Simpson 260 v.o.m.

rent permitted by the protector is 3.6 times 50 or 180 microamperes. Refer to the v.o.m. manual for the meter resistance and basic current sensitivity and then calculate the millivolt sensitivity and overload factor.

For momentary overloads, a 10× factor is safe; however, when the factor is well above 20×, a meter could be damaged. In an original circuit, it is possible to reduce the overload factor by adding resistance in series with the meter and shunting the diode across both. This increases the meter's millivolt sensitivity or meter drop.

Meter and Diode Fusing

Fig. 3A shows a voltage source V having an internal impedance R_i delivering load current I_L to load R_L . $D1$ and $D2$ are the shunt diodes of the meter protector. If R_L is shorted, the short-circuit current is $(V - \mathcal{V})/R_i$ for diodes limiting at 900 millivolts. Currents can easily rise to several amperes or more and destroy both diodes and meter unless the current is limited by a resistor or interrupted by a fuse.

Many v.o.m.'s, on current ranges, use the circuit of Fig. 3B. Note that the diodes are *directly* across the plus and minus test leads of the instrument and are therefore exposed to the full voltage that may be inadvertently placed across the meter. Such circuits require fusing.

Other v.o.m.'s, such as the *Simpson 260*, use the circuit of Fig. 3C. Note that the diode is not across the test leads because of the presence of the 3000-ohm resistor. This resistor acts as a current limiter tending to protect the diode, although this is not its primary circuit function. Fusing is optional, though preferable.

For maximum protection and because many of the overload factors in Table 1 are near or above 10×, it is necessary to interrupt the overload current within one-half to one second. This avoids overheating delicate meter hairsprings and is done by fast-action fusing.

Fuse ratings are based on the diode current ratings, allowing the use of low-cost, low-resistance fuses. Table 2 lists fast-blow instrument-fuse characteristics in the 1/8- to 1-ampere range. Use a 1/8-ampere fuse for the *Ohmite OMC7111*,

as it will clear within once second at 220 milliamperes. Use a 1/4-ampere fuse for the *Lectrotech "Metergard."* Surge-rated diodes permit use of larger fuses if this is necessary to reduce fuse resistance. Either the .01- or 1-second clearing times in Table 2 may be employed, depending upon how the diode is surge-rated.

In multi-range v.o.m.'s, when the highest current range is less than the selected fuse rating, (*Continued on page 76*)

Fuse Rating (Amperes)	Approximate Resistance* (Ohms)	Blow Current (Amperes) for Clearing Time of .01 sec	Blow Current (Amperes) for Clearing Time of 1 sec
1/8	8	.5	.22
1/4	2.3	1.3	.42
1/2	.92	3.0	.80
3/4	.45	4.4	1.1
1	.31	7	1.5

*Cold resistance at 10% rated current of Bussmann AGX (formerly 8AG) fast-action instrument fuses. Resistances of standard AGC (formerly 3AG) types are close to these values.

Table 2. The nominal resistances along with the blow characteristics of Bussmann instrument fuses.

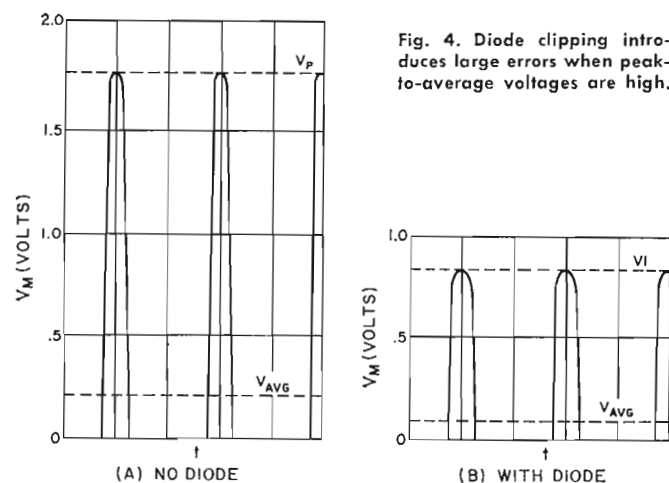

Fig. 4. Diode clipping introduces large errors when peak-to-average voltages are high.



JOHN FRYE

Under the terms of a recently passed benefits act, veterans are entitled to receive broad-based educational assistance.

THE 1966 G.I. BILL

"MAN, am I tuckered!" Barney said, smothering a yawn. "What kept you up late, hamming or dating?" Mac, his boss, asked. "Nothing so fun-type," Barney replied. "A cousin of mine, fresh out of the Army and just home from Vietnam, and I were trying to figure out what help he could expect in continuing his interrupted education under the new Veterans' Readjustment Benefits Act of 1966. Believe me," Barney said, tapping a pamphlet on the bench in front of him, "wading through Public Law 98-358 here is worse than trying to trace one of those postage-stamp-size circuits pasted in the back of a Japanese transistor radio."

"Okay," Mac said, lighting his pipe and leaning back against the bench, "tell me about it. You know you're busting to."

"Thought you'd never ask," Barney said with a grin. "Anyway, the purpose of the bill is to make service in the Armed Forces more attractive, to help young people get an education they could not otherwise afford, and to compensate in part for educational and career sacrifices made by young men serving their country."

"Who's eligible for this help?"

"You make a wonderful straight man; you ask precisely the right questions—the ones I can answer," Barney marveled. "Any veteran is eligible for benefits who served on active duty for more than 180 days, any part of which occurred after January 31, 1955, and who was released under conditions 'other than dishonorable.' If he was released from active duty after January 31, 1955 for a service-connected disability, the 180-days-plus requirement is waived. And if he has served on active duty for at least two years and continues to serve on active duty, he is eligible for benefits while still in the service."

"But he doesn't get active-duty credit for training. He can't count a period when assigned by his service full-time to a civilian institution for a course substantially the same as one offered civilians, or periods of service as a cadet or midshipman in a service academy, or active training in the National Guard or Reserves."

"Where can he go to school? What kind of courses can he take?"

"He can attend any institution *approved for training*, including public or private secondary, vocational, correspondence, or business school; junior or teachers' college, normal school, college or university, professional, scientific, or technical institution, or any other institution which furnishes education at the secondary level or above."

"I notice you say 'approved' institution. I don't suppose the benefit would be granted for a course in surfboard riding."

"You suppose right. The Veterans' Administrator will not approve any course which is avocational or recreational in character unless the veteran can prove the course will be of practical use in his present or contemplated business or occupation. The Administrator ordinarily will not approve flight training, apprentice or other on-the-job training or

institutional on-farm training. Neither will benefits be granted for open-circuit TV courses unless they are part of an in-residence program leading to a college degree."

"Let's get to the grubby, but interesting, details: how much money will the veteran receive?"

"That depends on several factors. If he engages in full-time institutional training, consisting of a minimum of 14 semester hours or the equivalent, he will be eligible for \$100 per month. Having one dependent raises this to \$125. Two dependents or more brings it to \$150. On the other hand, if he takes only three-quarter time training, consisting of 10 to 13 semester hours or equivalent, the monthly payments are reduced to roughly three-fourths those figures. If he takes half-time training, consisting of 7 to 9 hours, payments are reduced to approximately one-half the full-time figures. Payments for a person taking less than half-time training or for one taking training while on active duty are computed at the rate of the established charges for tuition and fees required of non-veterans taking the course or at \$100 per month for a full-time course, whichever is the lesser. Payments for veterans taking co-operative training is \$80 a month for no dependents, \$100 for one dependent, and \$120 for two or more dependents."

"How about veterans taking courses by correspondence?"

"The educational assistance allowance will be computed on the basis of the established charge paid by non-veterans for the same courses. The actual-cost allowance is paid quarterly on a *pro rata* basis for the lessons completed by the veteran and serviced and certified by the school."

"How long do these payments go on?"

"Each eligible person is entitled to educational assistance for a period of one month, or the equivalent in part-time training, for each month or fraction thereof of his active-duty service after January 31, 1955, but not to exceed 36 months. Thus entitlement resulting from three years of active service would see the veteran through four years of college if he attended full-time nine months per year. If he took half-time training, he would use up half a month of his entitlement and receive half the full-time rate for each month he took the training. As you can see, this works out so all veterans eligible for the same amount of entitlement can eventually receive substantially the same amount of assistance whether they elect to take full, three-quarter, or half-time training. In the case of a veteran taking a program of education exclusively by correspondence, $\frac{1}{4}$ the elapsed time in following this program would be charged against his period of entitlement."

"Isn't there any limit on the time this offer is good?"

"In a way, yes. The veteran's education must be completed within eight years from the date of his discharge or from June 1, 1966, whichever is later."

"Can the assistance be lost for any reason?"

"You bet. The Administrator must discontinue the allowance if, at any time, he finds the veteran's conduct or progress unsatisfactory according to regularly prescribed standards and practices of the school in which he is en-



Introducing EICO's New "Cortina Series"!

Today's electro-technology makes possible near-perfect stereo at moderate manufacturing cost; that's the design concept behind the new EICO "Cortina" all solid-state stereo components. All are 100% professional, conveniently compact (3 1/8"H, 12"W, 8"D), in an esthetically striking "low silhouette." Yes, you can pay more for high quality stereo. But now there's no need to. The refinements will be marginal and probably inaudible. Each is \$89.95 kit, \$119.95 wired.

Model 3070 All-Silicon Solid-State 70-Watt Stereo

Amplifier: Distortionless, natural sound with unrestricted bass and perfect transient response (no inter-stage or output transformers); complete input, filter and control facilities; failure-proof rugged all-silicon transistor circuitry.

Model 3200 Solid-State FM/MPX Automatic Stereo Tuner: Driftless, noiseless performance; 2.4µV for 30db quieting; RF, IF, MX are pre-wired and pre-tuned on printed circuit boards — you wire only non-critical power supply.

7 New Ways to make Electronics more Fun!

Save up to 50% with EICO Kits and Wired Equipment.



You hear all the action-packed capitals of the world with the NEW EICO 711 "Space Ranger" 4-Band Short Wave Communications Receiver — plus ham operators, ship-to-shore, aircraft, Coast Guard, and the full AM band. 550KC to 30MC in four bands. Selective, sensitive super-het, modern printed circuit board construction. Easy, fast pinpoint tuning; illuminated slide-rule dials, logging scale; "S" meter, electrical bandspread tuning, variable BFO for CW and SSB reception, automatic noise limiter. 4" speaker. Headphone jack. Kit \$49.95. Wired \$69.95.



More "ham" for your dollar than ever — with the one and only SSB/AM/CW 3-Band Transceiver Kit, new Model 753 — "the best ham transceiver buy for 1966" — Radio TV Experimenter Magazine. 200 watts PEP on 80, 40 and 20 meters. Receiver offset tuning, built-in VOX, high level dynamic ALC, silicon solid-state VFO. Unequaled performance, features and appearance. Sensationally priced at \$189.95 kit, \$299.95 wired.

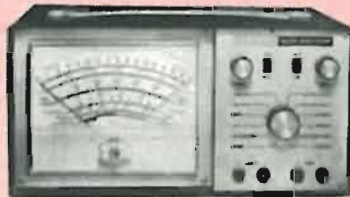

NEW EICO 888 Solid-State Engine Analyzer

Now you can tune-up, trouble-shoot and test your own car or boat.

Keep your car or boat engine in tip-top shape with this completely portable, self-contained, self-powered universal engine analyzer. Completely tests your total ignition/electrical system. The first time you use it — just to tune for peak performance — it'll have paid for itself. (No tune-up charges, better gas consumption, longer wear) 7 instruments in one, the EICO 888 does all these for 6V and 12V systems; 4, 6 & 8 cylinder engines.

The EICO 888 comes complete with a comprehensive Tune-up and Trouble-shooting Manual including RPM and Dwell angle for over 40 models of American and Foreign cars. The Model 888 is an outstanding value at \$44.95 kit, \$59.95 wired.



New EICOCRAFT® easy-to-build solid-state electronic TruKits:® great for beginners and sophisticates alike. As professional as the standard EICO line — only the complexity is reduced to make kit-building faster, easier, lower cost. Features: pre-drilled copper-plated etched printed

circuit boards; finest parts; step-by-step instructions; no technical experience needed — just soldering iron and pliers. Choose from: Fire Alarm; Intercom; Burglar Alarm; Light Flasher; "Mystifier"; Siren; Code Oscillator; Metronome; Tremolo; Audio Power Amplifier; AC Power Supply. From \$2.50 per kit.



There's more PUNCH in the new EICO "Sentinel-Pro" 23-channel Dual Conversion 5-watt CB Transceiver. New advanced Big-Reach "Range Plus" circuitry lengthens "talk-power" reach. Automatic noise limiter super-sensitizes for weak signals. "Finger Tip" antenna loading and transmitter tuning controls. 23 crystal-controlled transmit and receive channels — all crystals supplied. Rear-illuminated S/R/F meter. Transistorized 12VDC and 117VAC dual power supply. Wired only, \$169.95. Positive-Negative Ground/Mobile Marine Modification kit (optional \$5.95).



Model 460 Wideband Direct-Coupled 5" Oscilloscope. DC-4.5mc for color and B&W TV service and lab use. Push-pull DC vertical amp., bal. or unbal. input. Automatic sync limiter and amp. \$99.95 kit, \$139.50 wired.

FREE 1967 CATALOG

EICO Electronic Instrument Co., Inc. EW-11
131 01 39th Ave., Flushing, N. Y. 11352

Send me FREE catalog describing the full EICO line of 200 best buys, and name of nearest dealer. I'm interested in:

- test equipment
- stereo/hi fi
- automotive electronics
- ham radio
- Citizens Band radio

Name _____
Address _____
City _____
State _____ Zip _____



Model 232 Peak-to-Peak VTVM. A must for color or B&W TV and industrial use. 7 non-skip ranges on all 4 functions. With exclusive Uni-Probe.® \$29.95 kit, \$49.95 wired.

CIRCLE NO. 120 ON READER SERVICE CARD

Electronics World SUBSCRIBER SERVICE

Please include an address label when writing about your subscription to help us serve you promptly. Write to: Portland Place, Boulder, Colo. 80302

Change of Address:

Please let us know you are moving at least 4 weeks in advance. Affix magazine address label in space to the right and print new address below. If you have a question about your subscription, attach address label to your letter.

To Subscribe:

Check boxes below.

- New Renewal
 5 years \$21
 3 years \$15
 1 year \$6

Specify

- Payment enclosed
 — You get 1 extra issue per year FREE!

- Bill me later.

AFFIX LABEL

If you have no label handy, print OLD address here.

name
address
city
state
zip-code

please print

name please print 0147

address

city

state zip-code

Enjoy the "music-only" programs now available on the FM broadcast band from coast to coast.

- NO COMMERCIALS •
- NO INTERRUPTIONS •

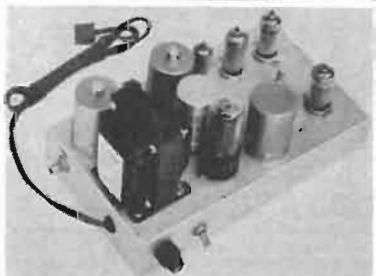

It's easy! Just plug Music Associated's Sub Carrier Detector into multiplex jack of your FM tuner or easily wire into discriminator. Tune through your FM dial and hear programs of continuous, commercial-free music you are now missing. The Detector, self-powered and with electronic mute for quieting between selections, permits reception of popular background music programs no longer sent by wire but transmitted as hidden programs on the FM broadcast band from coast to coast. Use with any FM tuner. Size: 5½" x 6". Shipping weight approx. 7 lbs.

KIT \$49.50
 (with pre-tuned coils, no alignment necessary)

WIRED \$75.00

COVER \$4.95 EXTRA

Current List of FM Broadcast Stations with SCA authorization\$1.00

MUSIC ASSOCIATED

65 Glenwood Road, Upper Montclair, New Jersey
 Phone: (201)-744-3387

CIRCLE NO. 99 ON READER SERVICE CARD

rolled. However, the Administrator can renew the allowance if the cause of the unsatisfactory conduct or progress is removed and the program the veteran now proposes to pursue—whether old or new—is suited to his aptitudes, interests, and abilities.

"Then he can change his course?"

"Each veteran can make one change of program of education if his original program has not been interrupted or discontinued through his own fault. However, the Administrator may approve one additional change (or an initial change otherwise not permitted because of the student's failure) if it seems the veteran has a better likelihood of success by undertaking a new program."

"You spoke of a veteran's obtaining this educational assistance while still in service. Does that mean he could be paid for training in a foreign school?"

"In some approved institutions of higher learning, yes. Keep in mind that *any* institution in which the veteran takes training, domestic or foreign, must have VA approval before the educational assistance will be allowed. Furthermore, the Administrator at his discretion may deny or discontinue educational assistance to a vet in a foreign educational institution if he finds such enrollment is not for the best interest of the veteran or the Government."

"Let's suppose our veteran is already engaged in a program of education at his own expense when payments started on June 1, 1966. Can he obtain educational assistance to help him continue this program? Can he obtain retroactive payments back to the time he started the course?"

"By obtaining approval of his course, he could receive payments to help him continue that course, but he could not obtain any retroactive payments going back beyond June 1, 1966. Benefits are paid starting with June, 1966 but only to veterans beginning a course in that month or those enrolled in a course which will continue beyond that month."

Mac reached over and picked up the pamphlet to which Barney had been referring and leafed through it. "Did you winnow all this information out of the fine print in this booklet?" he demanded.

"I had other help," Barney admitted. "The Veterans' Administration, Washington, D.C. 20420, put out a summary of the Act entitled 'VA Pamphlet 23-66-1' that helps explain the legal wording. And the National Home Study Council, 1601 18th Street, N.W., Washington, D.C. 20009, has issued a couple of clarifying bulletins, #14 and #26, that are most helpful in understanding the law, especially as it pertains to correspondence schools. My cousin had these with him."

"Just what does your cousin, or any

other eligible person, have to do to obtain this educational assistance under the new G.I. Bill?"

"First, he obtains an application form at any VA office, active-duty station, or American Embassy. He fills this out and submits it to the nearest VA Regional Office if he is in the United States. If he is living outside the country, he submits his application and all subsequent communications to the nearest American Embassy for transmittal to the VA Benefits Office, 2033 M Street, N. W., Washington, D.C. 20421. If he is a veteran, he encloses a copy of his separation document, DD Form 214, with the application. Active-duty personnel must submit a Statement of Service from their Commanding Officer or designate. To receive additional allowance for a dependent (wife, child, or dependent parent), a certified copy of the public record of the marriage, birth, etc., should also accompany the application."

"I hope every veteran now eligible, and every one who later becomes eligible, will apply for this educational assistance," Mac said. "It's a wonderful opportunity, honestly earned, for these fellows to equip themselves to take their rightful place in the world they have helped preserve. And I'll bet a lot of them will take their training in our field—not necessarily in service work, but in some of the many other branches of electronics offering an attractive future, such as computers, space electronics, medical electronics, communications, color-TV broadcasting, and industrial electronics."

"After all, most of those men have had to postpone their own plans for college or advanced training and it is only fair for Uncle Sam to give them a hand when they've finished the job. Such financial help is a very small return for what they've done for us."

"I'm with you, and the thing I like about the Act is its broad base. It offers something to practically every veteran. If he already has the necessary credits, he can use his benefits to become an electrical engineer or an electronics engineer. If he lacks the credits to get into a university or if he wants to work while he is training, he can take part-time vocational training or can secure his education at his own pace through correspondence. Fellows who learn more easily by doing rather than studying can take advantage of the cooperative schools. Finally, through the active-service allowance, a person in the Armed Forces can, if he wishes, start his training while he is still on active duty."

"Yep," Mac concluded the conversation, "the opportunity is there for the taking, and if I were eligible I'd certainly take advantage of it at the very first chance." ▲

CIRCLE NO. 86 ON READER SERVICE CARD →



Now instant movies in sound start at \$695.

The new Sony Videocorder deck (model CV-2000D) is both compact and versatile. It's also quite reasonably priced, \$695.

It's just like current Sony Videocorder models, but without the built-in TV monitor. Using a separate monitor or TV set, you can tape selected TV programs off-the-air. Add the optional Sony TV camera and you can tape "live" action in sight and sound. Play back your tape, and you'll see instant movies in sound.

This new deck is small enough to fit on a bookshelf, as a part of your hi-fi component system. Light enough (only 44 lbs.) to take wherever you want it to perform. Adaptable enough to use with any TV monitor, small or large screen (the new Sony 8*-inch and 22*-inch receiver/monitors are perfect mates). It can be adapted to work with most home TV sets. Handsome too, in walnut-finish cabinet.

Looking for a Videocorder with its own built-in monitor? Then meet the rest of the Sony Videocorder family. TCV-2010 complete in its own carrying case, \$995. The TCV-2020, handsome oil-finish walnut cabinet and with built-in timer to automatically tape TV programs while you're away, \$1150. For taping "live" action, there is the Video Camera Ensemble VCK-2000 (camera, elevator tripod, microphone) at \$350. For an unforgettable demonstration visit your Sony Videocorder dealer today. For free 16-page booklet write:

SONY® Corp. of America, 47-37 Van Dam St.,
Long Island City, N.Y. 11101 Dept. H

*diagonal measurement. The Videocorder is not to be used to record copyrighted material. Sony and Videocorder are registered trademarks of the Sony Corp. All prices suggested list.

The "Chip"

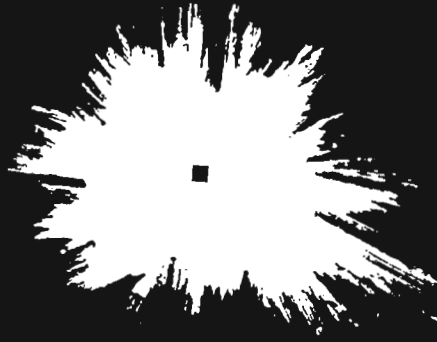

**...will it make or break
your job future?**

THE DEVELOPMENT OF INTEGRATED CIRCUITRY is the dawn of a new age of electronic miracles. It means that many of today's job skills soon will be no longer needed. At the same time it opens the door to thousands of exciting new job opportunities for technicians solidly grounded in electronics fundamentals. Read on the facing page what you need to know to cash in on the gigantic coming boom, and how you can learn it right at home.

TINY ELECTRONIC "CHIPS," each no bigger than the head of a pin, are bringing about a fantastic new Industrial Revolution. The time is near at hand when "chips" may save your life, balance your checkbook, and land a man on the moon.

Chips may also put you out of a job ... or into a better one.

"One thing is certain," said *The New York Times* recently. Chips "will unalterably change our lives and the lives of our children probably far beyond recognition."

A single chip or miniature integrated circuit can perform the function of 20 transistors, 18 resistors, and 2 capacitors. Yet it is so small that a thimbleful can hold enough circuitry for a dozen computers or a thousand radios.

Miniature Miracles of Today and Tomorrow

Already, as a result, a two-way radio can now be fitted inside a signet ring. A complete hearing aid can be worn entirely inside the ear. There is a new desk-top computer, no bigger than a typewriter yet capable of 166,000 operations per second. And it is almost possible to put the entire circuitry of a color television set inside a man's wrist-watch case.

And this is only the beginning!

Soon kitchen computers may keep the housewife's refrigerator stocked, her menus planned, and her calories counted. Her vacuum cleaner may creep out at night and vacuum the floor all by itself.

Money may become obsolete. Instead you will simply carry an electronic charge account card. Your employer will credit your account after each week's work and merchants will charge each of your purchases against it.

When your telephone rings and nobody's home, your call will automatically be switched to the phone where you can be reached.

Doctors will be able to examine you internally by watching a TV screen while a pill-size camera passes through your digestive tract.

New Opportunities for Trained Men

What does all this mean to someone working in electronics who never went beyond high school? It means the opportunity of a lifetime—if you take advantage of it.

It's true that the "chip" may make a lot of manual skills no longer necessary.

But at the same time the booming sales of articles and equipment using integrated circuitry has created a tremendous demand for trained electronics personnel to help design, manufacture, test, operate, and service all these marvels.

There simply aren't enough college-trained engineers to go around. So men with a high school education who have mastered the fundamentals of electronics theory are being begged to accept really interesting, high-pay jobs as engineering aides, junior engineers, and field engineers.

How To Get The Training You Need

You can get the up-to-date training in electronics fundamentals that you need through a carefully chosen home study course. In fact, some authorities feel that a home study course is the best way. "By its very nature," stated one electronics publication recently, "home study develops your ability to analyze and extract information as well as to strengthen your sense of responsibility and initiative." These are qualities every employer is always looking for.

If you do decide to advance your career through spare-time study at home, it makes sense to pick an electronics school that specializes in the home study method. Electronics is complicated enough without trying to learn it from texts and lessons that were designed for the classroom instead of correspondence training.

The Cleveland Institute of Electronics has everything you're looking for. We teach only Electronics—no other subjects. And our courses are designed especially for home study. We have spent over 30 years perfecting techniques that make learning Electronics at home easy, even for those who previously had trouble studying.

Your instructor gives your assignments his undivided personal attention—it's like being the only student in his "class." He not only grades your work, he analyzes it. And he mails back his corrections and comments the same day he gets your lessons, so you read his notations while everything is still fresh in your mind.

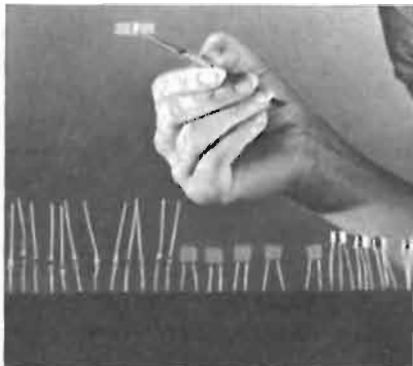

50 FUNCTIONS IN A SINGLE CHIP. The functions of these 50 separate transistors, diodes, resistors and capacitors can now be formed by the tiny dot in the center of the integrated circuit held by the tweezers.

Always Up-To-Date

Because of rapid developments in electronics, CIE courses are constantly being revised. Students receive the most recent revised material as they progress through their course. This year, for example, CIE students are receiving exclusive up-to-the-minute lessons in Microminiaturization, Logical Troubleshooting, Laser Theory and Application, Single Sideband Techniques, Pulse Theory and Application, and Boolean

Algebra. For this reason CIE courses are invaluable not only to newcomers in Electronics but also for "old timers" who need a refresher course in current developments.

Praised by Students Who've Compared

Students who have taken other courses often comment on how much more they



TINY TV CAMERA for space and military use is one of the miracles of integrated circuitry. This one weighs 27 ounces, uses a one-inch vidicon camera tube, and requires only four watts of power.

learn from CIE. Mark E. Newland of Santa Maria, California, recently wrote: "Of 11 different correspondence courses I've taken, CIE's was the best prepared, most interesting, and easiest to understand. I passed my 1st Class FCC exam after completing my course, and have increased my earnings \$120 a month."

Get FCC License or Money Back

No matter what kind of job you want in Electronics, you ought to have your FCC Commercial License. It's accepted everywhere as proof of your education in Electronics. And no wonder—the Government licensing exam is tough. So tough, in fact, that without CIE training, two out of every three men who take the exam fail.

But better than 9 out of every 10 CIE-trained men who take the exam pass... on their very first try!

This has made it possible to back our FCC License courses with this famous Warranty: you *must* pass your FCC exam upon completion of the course or your tuition is refunded in full.

Mail Card For Two Free Books

Want to know more? The postpaid reply card bound in here will bring you free copies of our school catalog describing today's opportunities in electronics, our teaching methods, and our courses, together with our special booklet on how to get a commercial FCC License. If card has been removed, just send us your name and address.

VETERANS

If you had active duty in any branch of the Armed Forces after January 31, 1955, you may be entitled to Government-paid tuition for any CIE course.



Cleveland Institute of Electronics

1776 E. 17th St., Dept. EW-23, Cleveland, Ohio 44114

Accredited Member National Home Study Council • A Leader in Electronics Training... Since 1934

TWO NEW "plastic view" screwdriver kits

EASY TO USE, CARRY & STORE

These neat, extremely compact kits fit hip pocket, tool box, boat kit, glove compartment . . . can also be hung on a wall. Durable "Plastic View" zipper case permits instant identification of tools.

Amber plastic (UL) Service Master handles are shockproof, breakproof, have patented spring holding device that accepts all Xcelite Series 99 blades — lets you add tools as needed at minimum cost.

Space saving, single-ended interchangeable blades . . . can be used with Xcelite extensions for extra reach.



99PV-6

Handle and 3 slotted screwdriver blades ($\frac{3}{16}$ ", $\frac{1}{4}$ ", $\frac{5}{16}$ " tips), 2 Phillips (#1, #2)



99PV-4

Handle and 3 slotted screwdriver blades ($\frac{3}{16}$ ", $\frac{1}{4}$ ", $\frac{5}{16}$ " tips)

WRITE FOR CATALOG 166

XCELITE®

XCELITE, INC., 12 Bank St., Orchard Park, N. Y. 14127

In Canada contact Charles W. Pointon, Ltd.

CIRCLE NO. 82 ON READER SERVICE CARD

RADIO & TV NEWS

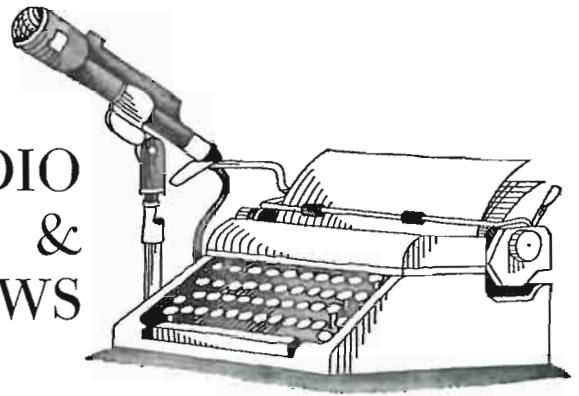

EUROPEAN color TV has reached an impasse. At a recent meeting in Oslo, Study Group XI (TV) could not agree on which color system to use in Europe, so each country is now free to choose, at its discretion, the color-TV system that seems most suitable to it.

The majority of Western European countries—Denmark, Eire, Finland, Great Britain, Iceland, Italy, Liechtenstein, Netherlands, Norway, Sweden, Switzerland, and the Federal Republic of Germany—have chosen the PAL system. Next year Great Britain, Netherlands, Italy, and the Federal Republic of Germany will start PAL color broadcasting.

France, Greece, and Monaco have decided on SECAM III, as have the Eastern Bloc countries of Albania, Byelorussia, Bulgaria, Czechoslovakia, Hungary, Poland, Rumania, the Ukraine, the U.S.S.R., and Yugoslavia.

The British territories of Australia, New Zealand, South Africa, and Nigeria advocated PAL, while Iran and Israel acknowledged the technical advantages of this system.

Twenty-two countries outside Europe, including 16 African nations, nine of which have no TV at all, voted for SECAM.

The political controversy at Oslo grew to such an extent that a new system, spawned by a French and Russian alliance, was put up as a compromise. This system, called SECAM IV, is a variant of the French SECAM system further worked over by the NIIR (Nautschno Iseledowatelski Institut Radio), the U.S.S.R.'s scientific radio research institute. Both the French and Russians admitted that their composite system was not finished, and its features are still unknown. From these purely technical aspects, there seem to be no prospects for the compromise proposal.

The situation now looks like this. At present, there are eleven monochrome standards in Europe. This means that there would have been 11 color standards if one color system had been adopted for all countries. With each faction in Europe now ready to produce color TV with one of three (in-

compatible) systems, the color-TV picture grows infinitely more complex, and an exchange of programs within Europe or across the Atlantic will be impossible without the use of a number of scan converters in the transmission path.

Laser Earthquake Detector

One of the major problems with earthquakes is that they happen at almost unpredictable times. Now, however, three scientists at *The Boeing Co.* have disclosed that they have been measuring movements along earth faults within the shaft of an abandoned mine tunnel in California for the past two years, using a laser beam in a specially designed interferometer.

The laser interferometer measures small earth strains in two independent directions along an earth fault that intersects the mine tunnel. Buildup of these infinitesimal strains is thought to precede a major earth shift at the fault lines.

In essence, the interferometer measures the difference in phase between a light wave crossing the earth fault and a beam that does not cross the fault. Variations in phase between the two beams can indicate earth movements of less than a millionth of a centimeter.

New Phono Styli

The major difference between the two types of phono styli presently available, the diamond and the sapphire, is that the diamond far outlasts the sapphire in use. This is due to the fact that a diamond crystal is very abrasion-resistant along certain of its crystal axes. Because of its great hardness and resultant high cost of fabrication, the diamond is expensive.

Sapphire, on the other hand, can be easily worked to the correct tip shape, but this relative softness reduces its operating life.

Now, scientists at *Toshiba* have developed a new stylus from special crystal-oriented corundum (aluminum oxide, the hardest mineral except for the diamond). These new styli are expected to be as low in cost as a sapphire yet have the life of a diamond. ▲

NEW
FROM
ALLIED

knight-kit® Safari II & III **Citizens Band Transceivers**

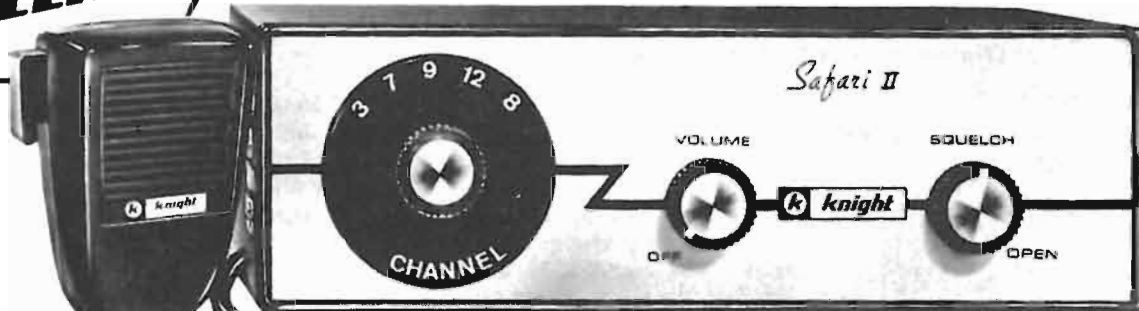

With Mike/Speaker,
Channel 9 Crystals
\$59.95

Safari II 5-Watt 5-Channel Transceiver Kit

Versatile, easy and fun to build, features compact solid-state design with factory assembled and aligned transmitter section, yet is priced remarkably low. Full 5 watts input power, 5 crystal-controlled channels. Just 2 1/8 x 6 7/8 x 8 1/2" overall. Connects to 12-volt battery in car, truck or boat in minutes . . . use as portable with optional battery pack, or as base station with optional AC supply. Simple 3-control operation—illuminated channel selector, squelch control, on/off volume control. Series gate noise limiter circuit overcomes interference. Unique push-to-talk microphone/speaker.

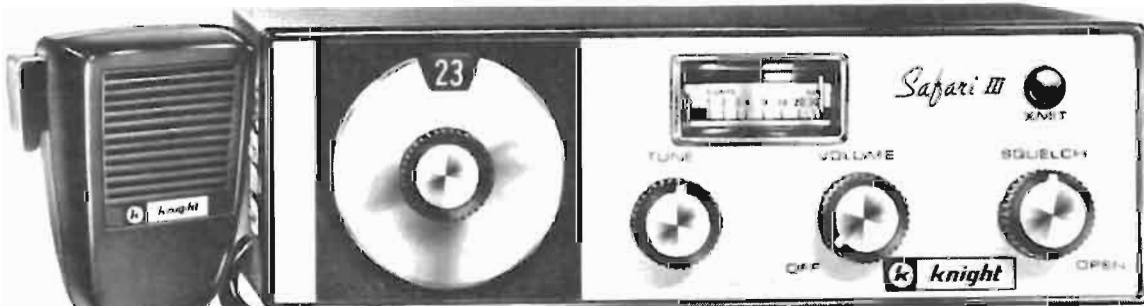

With Mike/Speaker,
Channel 9 Crystals
\$84.50

Safari III 5-Watt 23-Channel Transceiver Kit

Designed for those who want the best in CB at a low price. All the deluxe features of the Safari II above . . . PLUS provision for 23 crystal-controlled channels; easy-to-read front-panel "S" meter and fine tuning control to tune in stations that are off frequency; and transmit indicator light.

Read the unique money-back guarantee below . . . exclusive in the industry . . . then rush the coupon for full details and Special Introductory Offer.

KNIGHT-KIT GUARANTEE

Build a Knight-Kit in accordance with our easy-to-follow instructions. When you have completely assembled the kit, you must be satisfied or we will return your money, less transportation charges, under the Allied guarantee of satisfaction.

ALLIED RADIO

**ALLIED RADIO, Knight-Kit Div., Dept. 1-LL
P. O. Box 8528 Chicago, Illinois 60680**

Send me full details and Special Introductory Offer on the **Knight-Kit Safari II & III.**

Name _____ PLEASE PRINT

Address _____

City _____ State _____ Zip _____

CIRCLE NO. 106 ON READER SERVICE CARD

TEST EQUIPMENT

PRODUCT REPORT

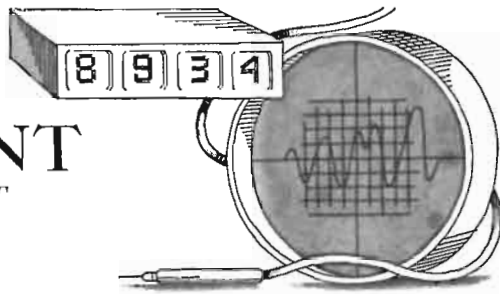

Triplet Model 630-APLK V.O.M.

For copy of manufacturer's brochure, circle No. 29 on Reader Service Card.



COMPLETE overload protection and high accuracy are two outstanding features of a new compact and rugged Triplet Model 630-APLK. The instrument is designed with a transistorized switching circuit (see schematic diagram) that guards against accidental burnouts, providing comprehensive overload protection and virtually eliminating bent pointers, changes in accuracy due to overheating, and burned-out resistors, shunts, and coils.

The key to the protection circuit is a transistorized amplifier which controls a manually reset latching-type relay. In operation, the amplifier detects the

voltage across the terminals of the meter. When this voltage exceeds the rated full-scale meter voltage by four to six times, the transistorized amplifier "fires" and energizes the latching relay. The contacts of the relay, located in the v.o.m. input circuit, latch open and remain open until the user depresses the manual reset button found to the right of the selector switch on the front panel. If the overloads are smaller and not sufficient to "fire" the amplifier, no damage can be caused to the instrument.

Auxiliary contacts on the latching relay automatically disconnect the meter's battery immediately after the relay is energized by the transistorized amplifier, preventing continuous battery drain. This feature allows the Model 630-APLK to be left in the relay-energized state for indefinite periods with no battery drain. In the normal operating condition, with the reset button "in," the overload protection amplifier draws negligible standby current. This current is less than one microampere, the approximate shelf-life drain on the 30-volt battery furnished with each instrument. A fuse in the input circuit provides added protection for the relay contacts.

Protection against overload damage is provided on all ranges. The one- and ten-ampere ranges are protected by 3- and 15-ampere fuses respectively.

The inherent high resistance of the 100,000-ohm, 1000- and 5000-volt a.c. and d.c. range circuits limits current to a level which will not damage the meter. All other ranges are protected by the transistorized overload safeguard.

Additional protection to the meter is provided through the use of a dual silicon-diode network. It prevents damage to the meter pointer by bypassing instantaneous transient voltages that might bend the meter pointer before the latching-relay contacts open.

The new v.o.m. has a sensitivity of 20,000 ohms per volt d.c. and 5000 ohms per volt a.c. It has an accuracy of $\pm 1\frac{1}{2}\%$ of full scale for all d.c. ranges with the exception of the 5000-volt range ($\pm 3\frac{1}{2}\%$) as well as an accuracy of $\pm 3\%$ for the a.c. ranges. All accuracies are based on meter placement in the horizontal position. All resistance ranges have an accuracy of $\pm 1\frac{1}{2}\%$ of scale length. A mirror-backed, $4\frac{1}{2}$ -inch-long scale insures reading accuracy by eliminating parallax.

The meter itself is a rugged suspension type having a sensitivity of 50 microamperes full scale. Conventional pivots, bearings, and hairsprings are completely eliminated; therefore, increased repeatability is provided. Friction between pivots and bearings is no longer a problem. Also, greater ruggedness and durability is achieved since there are no moving parts in contact, and the elimination of the hairspring prevents snagging and tangling. Temperature variations cannot cause sticky operation of the pointer.

The suspension system consists of a moving coil which floats in a magnet by virtue of the suspension bands held in tension by a spring. These bands, fabricated of precious-metal alloy, provide torque and carry the current to the moving coil. The moving-coil assembly is held by a rigid, one-piece, die-cast frame in a large self-shielded "bar-ring" magnet.

The Model 630-APLK volt-ohm-milliammeter is priced at \$95. ▲

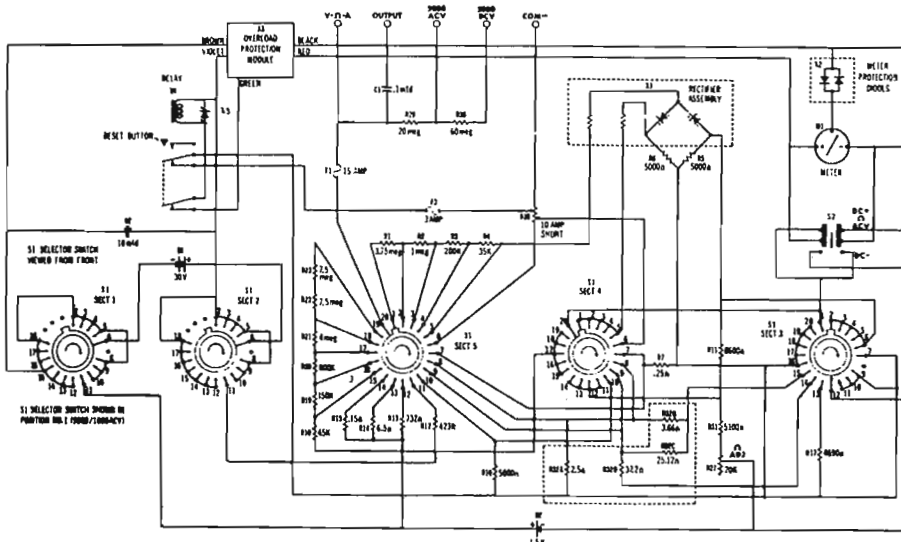

Eico Model 888 Engine Analyzer

For copy of manufacturer's brochure, circle No. 30 on Reader Service Card.

FOR the electronics man who likes to work on his own car, here is a piece of equipment that will do just about all his measurements for him. For example, the output of the voltage regulator can be checked on the 16-volt scale of the instrument; voltage drops in the car's wiring can be checked on the 3.2-volt scale; the setting of the current relay in the car's battery-charging circuit can be measured on the 90-ampere scale.

In addition to these useful voltage and current scales, the new Eico 888 incorporates a transistorized Schmitt



Free Photofact® Annual Index

for your use
throughout 1967



**send today for your instant handy guide
to the world's finest electronic service data!**

covers over 70,000 listings of:

TV Receivers • Home & Auto Radios • Phonos & Hi-Fi
CB Radios • Tape Recorders • Record Changers

NOW INCLUDES—

- Special Index to Color TV Receivers
- Complete Listing of Sams Technical Books
- Complete List of Sams Distributors

Send today for this valuable 136-page guide covering virtually every model of home-entertainment electronic equipment produced since 1946! Helps you locate the proper PHOTOFACT Folder to quickly solve any service problem in any model. PHOTOFACT provides *everything* you need in complete, uniform style for quick, effective repairs: Famous Standard Notation Schematics packed with the service details you need; Full Photo Coverage of all chassis views; Complete Replacement Parts Lists; Tube Placement Diagrams; Alignment Instructions; CircuiTrace® for printed boards; Disassembly Instructions; Dial Cord Diagrams; Changer and Recorder "Exploded Views"—plus dozens of other great features. Send coupon for your FREE copy of the latest PHOTOFACT Index to the service data you need!

JOIN THE PHOTOFAC-OF-THE-MONTH CLUB:

**ONLY \$10 PER MONTH NOW BRINGS
YOU 20% MORE PHOTOFAC COVERAGE
TO KEEP YOU AHEAD—SAVES YOU
OVER \$60 PER YEAR!**

For details, see your Sams Distributor, or send coupon

**THE "PHOTOFAC ANNUAL INDEX" AND
3 SUPPLEMENTS NOW PROVIDE COMPLETE
REFERENCE TO PHOTOFAC COVERAGE:**

Send for the Photofact Annual Index—your "master" reference throughout 1967. Once you are on our mailing list, you will automatically receive three additional Index Supplements (in February, May, and September, 1967) to keep you up-to-the-minute on Photofact coverage of the latest equipment released.



**HOWARD W. SAMS & CO., Dept. EWF-11
4300 W. 62nd St., Indianapolis, Indiana 46206**



Send **FREE 1967 Photofact Annual Index** and place my name on your mailing list to receive the Supplements

Send Photofact-of-the-Month Club details

My Distributor is _____

Shop Name _____

Attn.: _____

Address _____

City _____ State _____ Zip _____

Complete TUNER REPAIR

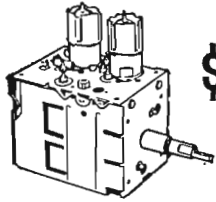

ONLY
\$9.50

Includes ALL parts (except tubes) . . . All labor on ALL makes. Fast 24-hour service with 1-year warranty

Sarkes Tarzian, Inc., largest manufacturer of TV and FM tuners, offers unexcelled tuner overhaul and factory-supervised repair service.

Tarzian-made tuners received one day will be repaired and shipped out the next. More time may be required on other makes. Every channel checked and realigned per original specs. And, you get a full, 12-month guarantee against defective workmanship and parts failure due to normal usage. Cost, including labor and parts (except tubes) is only \$9.50 and \$15 for UV combinations. Replacements at low cost are available on tuners beyond practical repair.

Always send TV make, chassis and Model number with faulty tuner. Check with your local distributor for Sarkes Tarzian replacement tuners, parts or repair service. Or, use the address nearest you for fast, factory-supervised repair service.

TUNER SERVICE  CORPORATION

(Factory-supervised tuner service authorized by Sarkes Tarzian)

MIDWEST—817 N. Pennsylvania St.
Indianapolis, Ind. Box 1642
Tel: 317-632-3493

EAST—547-49 Tonnele Ave.
Jersey City, New Jersey • Tel: 201-792-3730

SOUTH-EAST—938 Gordon St., S.W.
Atlanta, Georgia • Tel: 404-758-2232

WEST—SARKES TARZIAN, Inc.
Tuner Service Division
10654 Magnolia Blvd., N. Hollywood, Calif.
Tel: 213-769-2720

CIRCLE NO. 83 ON READER SERVICE CARD

GET INTO ELECTRONICS



V.T.I. training leads to success as technicians, field engineers, specialists in communications, guided missiles, computers, radar and automation. Basic & advanced courses in theory & laboratory. Electronic Engineering Technology and Electronic Technology curricula both available. Assoc. degree in 29 mos. B.S. also obtainable. G.I. approved. Graduates in all branches of electronics with major companies. Start February, September. Dorms, campus. High school graduate or equivalent. Write for catalog.

VALPARAISO TECHNICAL INSTITUTE
Dept. RD, Valparaiso, Indiana



trigger pulse counter (see diagram) that converts the instrument to a tachometer for measuring engine speed. Two ranges of 0-1200 rpm and 0-6000 rpm are available for 4-, 6-, or 8-cylinder engines. The tachometer function is calibrated against the 60-hertz power line using the special voltage-divider line cord supplied. This frequency corresponds to an engine speed of 1200 rpm for a 6-cylinder car, 900 rpm for an 8-cylinder car, or 1800 rpm for a 4-cylinder car. The trigger circuit does its job well, as we discovered when we calibrated the unit. We found that the rpm reading remained steady with sine-wave voltages applied from about 20 volts all the way down to about ½ volt. Below this value, the circuit was not triggered and the reading dropped to zero.

The instrument also serves as a dwell meter, measuring the number of degrees of rotation that the breaker points remain closed. To do this, the analyzer is used as an averaging ohmmeter that is connected across the breaker points. In a 6-cylinder engine, the maximum dwell time is 1/6 of 360°, or 60°. This

would occur with the points closed all the time. Normally, the points would be closed for just over half this time, so that the dwell would measure 30° to 35°, or whatever value is specified by the car manufacturer.

A most useful portion of the instruction manual for the 888 is a seven-page section covering proper idling speeds and dwell angles for just about all American and foreign cars, going back as far as 1950 for some models.

In addition to the features mentioned above, the instrument can also be used as a conventional ohmmeter, a diode tester (for the rectifiers employed with the car's alternator), and a spark-plug and ignition-coil tester. A built-in 0.22-μF capacitor can also be switched across the test leads to take the place of the one used across the breaker points in the car.

The analyzer can be applied to marine engines as well as auto engines. It is completely self-powered, using four easily replaced flashlight cells. The meter employed for all indications is six inches wide so that it can be readily seen from a considerable distance. The

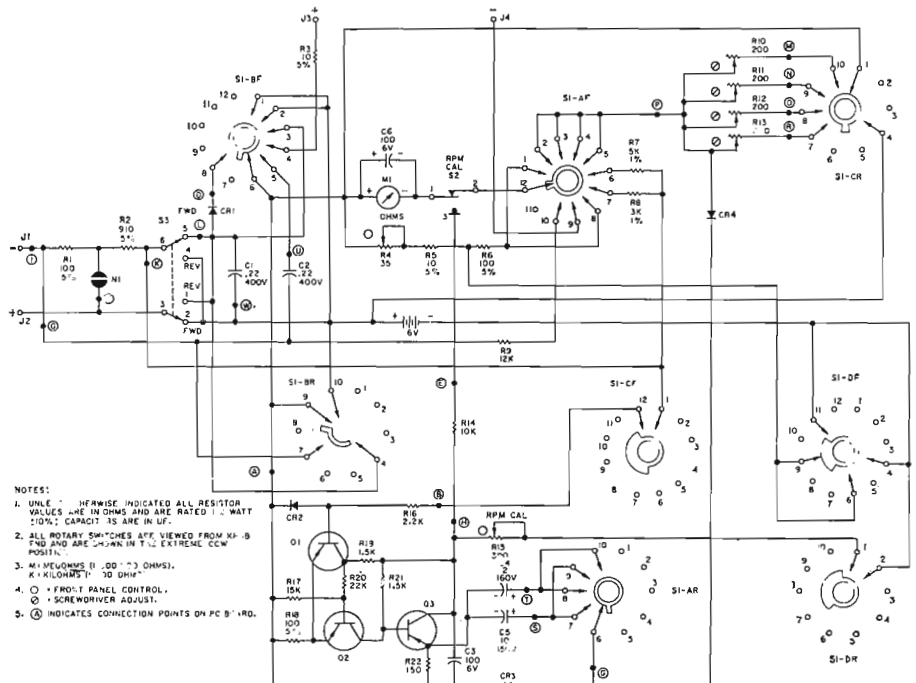

Model 888 sells for \$44.95 in kit form or \$59.95, factory-wired. ▲

Acopian Model K55 Regulated Power Supply

For copy of manufacturer's brochure, circle No. 153 on Reader Service Card.

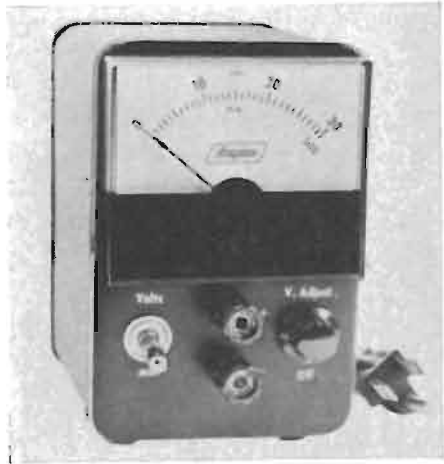

A WELL-regulated power supply that will deliver up to 30 volts d.c. at 300 mA has a number of important applications. It can be used to power most solid-state circuits in the laboratory, on the production line, or on the service bench. It can also be used in the classroom for industrial training programs or high school and college electronics courses. The Acopian Model K55 is just such a unit. It is small in size (only 3⁵/₁₆" x 5¹/₄" x 5³/₈" high) and light in weight (3 lbs).

The unit has a continuously variable output voltage from 1.25 to 30 volts with a full-load output current of 300 mA over the entire range (see diagram). The load regulation is $\pm 0.5\%$ or 50 mV, whichever is greater, while the line regulation from 105 to 125 volts is 10 mV. The supply has low output ripple, being only 1 mV r.m.s. at full load. The output binding posts are insulated from ground and floating.

The supply uses a full-wave silicon-diode bridge along with a four-silicon-transistor voltage-regulator circuit. Short-circuit protection is provided by the regulator circuit so that the supply can be used safely by students or inexperienced personnel. A built-in meter is included for monitoring voltage or current.

The compact power supply is available for \$98. ▲

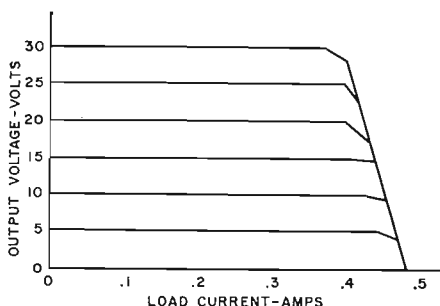

Announcing the new line of world-famous Schober Organ Kits...

ASSEMBLE YOUR OWN ALL-TRANSISTOR SCHOBER ELECTRONIC ORGAN



All-New, All-Transistor Schober Recital Organ

- 32 voices, 6 couplers delight professional musicians... make learning easy for beginners.
- Standard console, pedals, keyboard correspond exactly to pipe-organ specifications.
- Printed circuit construction and detailed, illustrated instructions make for easy assembly... no previous experience necessary.
- Highly accurate church and theatre pipe tone in 5 pitch registers make every kind of organ music sound "right".
- Optional: Combination Action, Schober Reverbatape Unit, Repetitive Theatre Percussions.
- All-transistor circuitry.

Designed by organists for organists, the new Schober Recital Organ actually sounds like a fine pipe organ. The newly-invented Schober Library of Stops provides you with an infinite number of extra voices so that you can instantly plug in the exact voices you prefer for a particular kind of music. Thirteen-piston, instantly resettable Combination Action makes the

Recital Organ suitable for the most rigorous church and recital work. The Schober Reverbatape Unit gives you big-auditorium sound even in the smallest living room. An instrument of this caliber would cost you \$5000 to \$6000 in a store. Direct from Schober, in kit form (without optional percussions, pistons, Reverbatape Unit) costs you only \$1500.



New, All-Transistor Schober Console II

Here's the most luxurious "home-size" organ available today... with the same circuitry and musical design as the impressive Recital Organ. Full 61-note manuals, 17 pedals, 22 stops and coupler, 3 pitch registers, and authentic

theatre voicing leave little to be desired. Musically much larger than ready-made organs selling for \$1800 and more... the Console II, in kit form, costs only \$850.



New Schober Spinnet

The Schober Spinnet is among the very smallest genuine electronic organs; only 39¹/₄ inches wide, it will fit into the smallest living room or playroom—even in a mobile home. Yet it has the same big-organ tone and almost the

same variety of voices as the larger Console II. The Schober Spinnet far exceeds the musical specifications of ready-made organs selling for \$1100 and more. In easy-to-assemble kits... only \$550.

HERE'S WHY YOU SHOULD BUILD A SCHOBER ORGAN!

You cannot buy a finer musical instrument for over twice the price. You get the finest in musical and mechanical quality.

It's easy to assemble a Schober Organ. If you can read and use your hands, you can easily make your own superb organ. Everything you need is furnished... including the know-how; you supply only simple tools and time—no knowledge or experience is required.

You can buy the organ section by section... so you needn't spend the whole amount at once.

You can begin playing in an hour, even if you've never played before—with the ingenious Pointer System available from Schober.

Thousands of men and women—teenagers, too—have already assembled Schober Organs. We are proud to say that many who could afford to buy any organ have chosen Schober because they preferred it musically.

Schober Organ Kits are sold in the U.S. only by...

THE *Schober Organ* CORPORATION

43 West 61st Street, New York, N.Y., 10023
Dealers in Canada, Australia, Hong Kong, Mexico, Puerto Rico and the United Kingdom.

SEND FOR FREE SCHOBER BOOKLET

Describes the exciting Schober Organ and optional accessories in detail. It includes a FREE 7-inch "sampler" record so you can hear before you buy.

Also available:
10-inch high quality, long playing record... fully illustrates all three models with different kinds of music. Price is refunded with first kit purchase... \$2.00



The Schober Organ Corp., Dept. RN-46
43 West 61st St., New York, N.Y., 10023

Please send me, without cost or obligation, the Schober Organ Booklet and free 7-inch "sampler" record.

Enclosed find \$2.00 for 10-inch quality, LP record of Schober Organ music. (\$2.00 refunded with purchase of first kit.)

Name _____
Address _____
City _____ State _____ Zip No. _____

CIRCLE NO. 90 ON READER SERVICE CARD

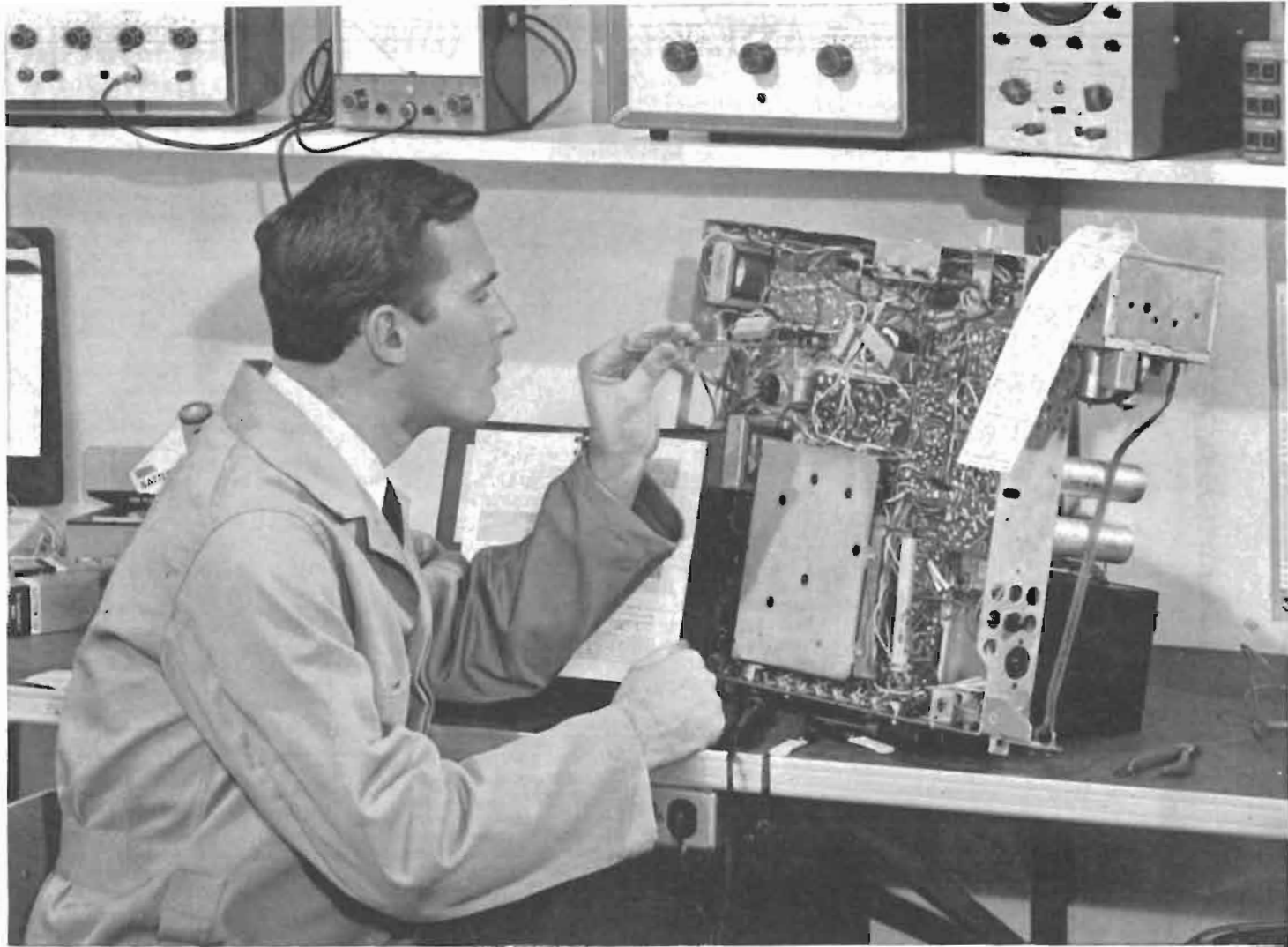

RCA TRAINING can be the smartest investment you ever made!

**Start building a profitable career in electronics now!
NEW RCA "AUTOTEXT" programmed instruction will help you
learn faster and easier!**

If you're considering a future in electronics, now is the time to start! A great new teaching aid—"AUTO-TEXT" programmed instruction developed by RCA and introduced by RCA Institutes will help you master the fundamentals of electronics almost automatically. Even people who have had trouble with conventional home training methods are finding it easier and more fun to start their training in Electronics Fundamentals the RCA way. Prove

it to yourself as others throughout the country are now doing. An interest or inclination in electronics is what you need. RCA "Autotext" helps you to do the rest. You'll be ready to go on to advanced training sooner than you ever thought possible! The future is unlimited; the jobs are available. The important thing is to get started now.

Founded in 1909, RCA Institutes is one of the largest technical schools in the United States devoted princi-

pally to electronics. The very name "RCA" means dependability, integrity, and scientific advance. RCA Institutes offers the finest facilities of home training. A Service of the Radio Corporation of America, RCA Institutes gives you the technical instruction you need to plan, build and realize the career you want in today's fastest growing field.

Investigate your future now at RCA Institutes. It can be the smartest investment you ever made.

HOME TRAINING COURSES

RCA Institutes offer this complete selection of Home Training Courses

- Electronic Fundamentals
- Electronic Fundamentals (in Spanish)
- TV Servicing
- Color TV Servicing
- Transistors

- Communications Electronics
- FCC License Preparation
- Mobile Communications
- Automation Electronics
- Automatic Controls

- Industrial Applications
- Nuclear Instrumentation
- Digital Techniques
- Computer Programming
- Drafting

Liberal Tuition Plan. All RCA Institutes Home Study courses are available under a Liberal Tuition Plan. This plan affords you the most economical possible method of home study training. You pay for lessons only as you order them. If, for any reason, you should wish to interrupt your training, you can do so and you will not owe a cent until you resume the course. No other obligations! No installment payments required.

RCA Personal Instruction. With RCA Home Study training you set your own pace in keeping with your own ability, finances and time. RCA Institutes allows you ample time to complete the course. Your lesson assignments are individually graded by technically trained personnel, and helpful comments are added where required. You get theory, experiment, and service practice beginning with the very first lesson. All lessons are profusely illustrated. You get a complete training package throughout the entire course.



You Get Prime Quality Equipment. All kits furnished with the course are complete in every respect, and the equipment is top grade. You keep all the equipment furnished to you for actual use on the job... and you never have to take apart one piece to build another.

CLASSROOM TRAINING IN NEW YORK CITY

No previous training required. You are eligible even if you haven't completed high school.

RCA Institutes Resident School in New York City offers training that will prepare you to work in rewarding positions on research and production projects in fields such as automation, transistors, communications, technical writing, television, computers, and other industrial and advanced electronics applications. If you did not complete high school, RCA will prepare you for such training with courses specially designed to provide the basic math and physics required for a career in electronics. Check classroom training on attached card, and full information will be rushed to you.

Free Placement Service. RCA Institutes graduates are now employed in important jobs at military installations with important companies such as IBM, Bell Telephone Labs, General Electric, RCA, and in radio and TV stations all over the country. Many other graduates have opened their own businesses. A recent New York Resident School class had 93% of the graduates who used the FREE Placement Service accepted by important electronics companies... and had their jobs waiting for them on the day they graduated!



Coeducational Day and Evening Courses. Day and Evening Courses are available at RCA Resident Schools in New York City. You can prepare for a career in electronics while continuing your normal full-time or part-time employment. Regular classes four times each year.

**SEND POSTCARD FOR FREE ILLUSTRATED BOOK TODAY!
SPECIFY HOME TRAINING OR CLASSROOM TRAINING.**

RCA INSTITUTES, INC. Dept. EW-N6 SERVICE OF RADIO CORPORATION OF AMERICA, 350 WEST 4TH ST., NEW YORK, N.Y. 10014



The Most Trusted Name in Electronics

THE WORLD'S MOST DISTINGUISHED PHOTOGRAPHIC ANNUAL



AND THE WORLD'S LARGEST SELLING PUBLICATION OF ITS KIND

For almost 20 years, in every corner of the world, the name **PHOTOGRAPHY ANNUAL** has meant just one thing: photographic excellence. The 1967 edition will show you why. It's the best yet. A brilliant collection of the year's most stimulating photographs, taken by the world's most gifted photographers and painstakingly selected by the editors of *Popular Photography*.

Over 200 exciting pages of superb, provocative pictures — magnificently reproduced in stunning color and dramatic black and white—and described in full technical detail to help you improve your photographic skills.

No wonder the **PHOTOGRAPHY ANNUAL** becomes a collector's item as soon as it goes on sale . . . why it outsells by far any similar publication in the field . . . why you'll turn to it again and again, month after month, year after year.

Order your copy now only **\$1.50**

Get the Handsome **LEATHERFLEX-COVERED EDITION** for just **\$3 P.P.**

PHOTOGRAPHY ANNUAL is also available in a splendid deluxe edition. Rugged Leatherflex cover provides lasting protection yet is softly textured and gold-embossed for the look of elegance. A collector's item—a superb addition to your Library of Photo Classics. And it's yours, for just **\$3 postpaid**, when you check the appropriate box on the order form.



Ziff-Davis Service Division, Dept. PA
589 Broadway, New York, N. Y. 10012

Please send my copy of the 1967 **PHOTOGRAPHY ANNUAL**.

- I am enclosing \$1.50 plus 15c for shipping and handling for the Regular Edition. (\$2.00 for orders outside U.S.A.)
- I am enclosing \$3.00. Please send me, postpaid, the Leatherflex-covered Deluxe Edition. (\$3.75 for orders outside U.S.A.) (Please allow 3 additional weeks for delivery of the Deluxe Edition.)

name _____ (PLEASE PRINT)
address _____ EW-116
city _____
state _____ zip code _____

Diode Meter Protectors

(Continued from page 57)

fusing at *B* in Fig. 3B sidesteps fuse resistance problems and also protects the meter shunts. If the highest selectable current range is above the fuse rating, place the fuse at *A* as shown. Fusing at *A* requires that the fuse resistance be no larger than 1% of the meter resistance to avoid excessive decalibration.

For a v.o.m. using a 1-milliamperere, 50-ohm meter, use a 1/4- or even 1-ampere fuse at *A*, along with a diode having at least a six-ampere surge rating. Fuse resistance is no problem in Fig. 3C due to high meter resistance.

Diode Clipping

D.c. currents in pulse and multivibrator circuits, unfiltered battery chargers, and unfiltered d.c. SCR power supplies often have very high peak-to-average values. Typical d.c. meters respond to average values. By voltage-limiting action, the diode protector will clip the peaks, resulting in very large meter error, particularly near full scale.

Fig. 4 shows the voltage waveforms observed across the load current meter of an unfiltered half-wave battery charger in operation. Peak voltage (V_p) to average (V_{avg}) is 9 to 1 in this case. Upon connecting the diode, it clipped at voltage V_1 and introduced a meter error of nearly 50%. (Compare V_{avg} in Fig. 4B with V_{avg} in Fig. 4A.)

To detect clipping, switch the v.o.m. to a higher current range and compare readings. A large difference indicates diode clipping, which can be reduced or eliminated by using a higher current range and restricting readings to the lower portions of the scale.

An effective remedy is to connect a capacitor across the meter terminals which will act like a filter for the a.c. components. Sizes may vary from .01- μ F disc types to 50- μ F transistor electrolytics, depending upon repetition frequencies and meter and circuit resistances. To be certain of obtaining the desired results, compare meter indications with the diode removed, diode attached, and with diode and capacitor connected. A capacitor permanently connected across the meter terminals has little or no effect on the v.o.m. a.c. ranges but this should be checked for the particular instrument being used.

Two diodes in series will double the meter's immunity to diode clipping. It will also reduce diode insertion error by more than one-half. However, it will double the overload factor by doubling the limiting voltage. But this is an acceptable compromise for meters having a low factor around 3 \times with one diode.

Diode Selection

The lower current rated diodes are

preferred for use with the more sensitive high-resistance meters. This reduces diode insertion errors to a minimum. The higher rated diodes are preferred for the lower resistance meters because they have high current-handling ability.

Ordinary top-hat and epoxy diodes are often suitable for use as protectors but may introduce larger diode insertion errors than the commercial protectors. Select the most suitable by noting the meter error at full scale on the *lowest* current range. Use two diodes back-to-back for v.o.m.'s, as in Fig. 3A.

When the meter current range is not very small compared with the diode rating, the diode is less able to carry the major part of the short-circuit current. Higher rated diodes such as stud types can be used to effect an improvement. One exception is the circuit of Fig. 3C in which the diode always sees a fairly large resistance regardless of the range-switch setting. Higher current meters are adequately protected with fast-action fusing alone.

To conclude, v.o.m.'s should be safeguarded by a properly matched diode-fuse combination for maximum protection of the costly meter. ▲

Linear IC's: What's Available

(Continued from page 42)

zero d.c. offset; the leakage when the gate is in another position is typically 1 nanoampere. The switch can safely pass 100 mA of current. Turn-on and turn-off times are 0.5 and 2 microseconds respectively.

Two other companies presently offer analog gates. These are *General Microelectronics* and *General Instrument Corp.* The latter provides an entire line of switches in its MEM5000 series, ranging from six-position single-throw through double-pole, double-throw. Prices are now in the \$40 to \$90 range, but the devices will inevitably become low-cost IC's once volume usage sets in and development costs have been returned. ▲



"That replaced Cosgrove . . . and I can't figure out what it does either."

ELECTRONIC CROSSWORDS

By JAMES R. KIMSEY

(Answer on page 104)

ACROSS

1. In a.c. theory, a polar..... in which voltages, currents, or impedances fan out from the center at their proper phase angles.
8. Third note in the musical scale.
9. Optical maser.
10. The current, voltage, or power that is fed into a circuit.
13. Designation for the band from 3000 to 30,000 MHz (abbr.).
15. Two of a kind (abbr.).
16. Possessing non-directional characteristics.
18. An oscillator circuit employing a screen-grid tube so connected that its input and output are internally connected by the streams of electrons from the cathode (abbr.).
19. Not happy.
21. Printer's measure.
22. Type of calibrated meter (abbr.).
23. A connecting wire, etc.
25. Familiar designation for a large Western city.
26. FCC designation for the band from 30 to 300 Hz.
27. Chemical abbreviation.
28. Type of switch.
32. Conceal.
33. Type of current (abbr.).
34. Variations of a chemical element, each having the same atomic number but different atomic weights.
37. Possess.
38. Type of connector.
39. Schematic designation for plate current of a vacuum tube.
42. A current distributor (abbr.).

43. Protective coating of cured plastic placed around delicate components.

DOWN

1. British Commonwealth term for tubes.
2. In series.
3. The unit of magnetic intensity in the cgs electro-magnetic system.
4. Any shifting of a station's signal from the original dial setting.
5. A practical unit of current (abbr.).
6. The common system of radio broadcasting (abbr.).
7. Unit of length equal to one-millionth of a meter.
11. Elevator direction.
12. The higher audio frequencies.
14. Licensed amateur radio operator.
17. Optical counterparts.
20. Malt beverage.
24. Sound waves capable of being heard (abbr.).
25. A vein of metallic ore.
27. Three-electrode vacuum tube.
28. Contact at the end of a plug.
29. Sixty (Rom. num.).
30. A metal partition or shield.
31. Pertaining to or utilizing sound waves.
32. Connected, alive, energized.
35. Waves whose frequency is higher than 1600 kHz (abbr.).
36. Type of antenna.
38. Small rug.
40. Sound network (abbr.).
41. Greek letter used as a symbol for amplification factor.
42. One-thousandth of an ampere (abbr.).

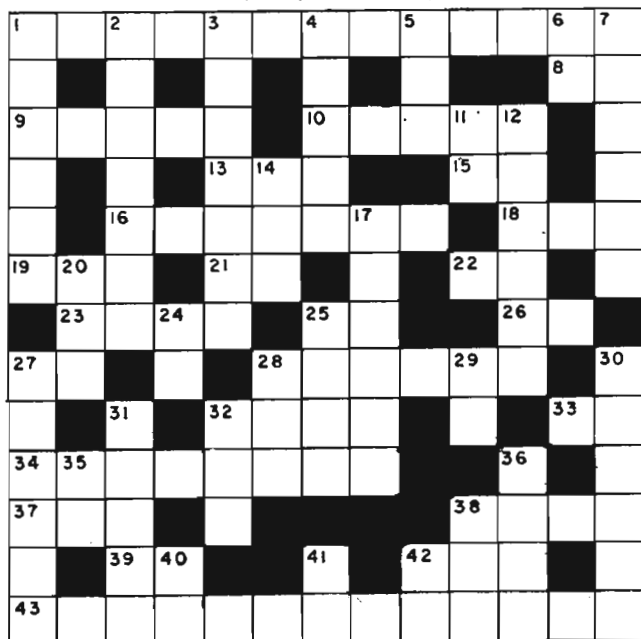

Technicians:

Keep learning while you earn.

IBM Customer Engineers learn every day. If you are qualified, you'll receive a training program with full pay. You'll be taught how to install and service IBM data processing equipment.

After that you will be given your own territory to handle. But you'll still keep learning. You will attend classes to keep you up-to-date on the latest in your field. The average Customer Engineer spends more than a month each year in IBM education programs.

It's a great way to learn a specialty. And you'll be preparing yourself for positions of greater responsibility in the fast-growing field of information handling and control.

If you have 2 years of technical school education (or equivalent experience), are handy with tools and know electronics, we'd like to see you. IBM is an Equal Opportunity Employer.

Please write, outlining your qualifications and interests, to Dept. 650Y at any of the locations listed below:

W. S. Bedford
IBM Field Engineering
400 Wyman Street
Waltham, Mass. 02154

D. L. Potts
IBM Field Engineering
425 Park Avenue
New York, New York 10022

C. E. Farnham
IBM Field Engineering
66 Glen Avenue
Glen Rock, New Jersey 07452

D. H. O'Neill
IBM Field Engineering
Seven Penn Center
Philadelphia, Pa. 19103

R. M. Baker
IBM Field Engineering
3833 North Fairfax Drive
Arlington, Virginia 22203

O. J. Agee
IBM Field Engineering
Room 240
1371 Peachtree St., N.E.
Atlanta, Georgia 30309

F. W. Garvin
IBM Field Engineering
20700 Greenfield Road
Oak Park, Michigan 48237

R. O. Berger
IBM Field Engineering
29 North Wacker Drive
Chicago, Illinois 60690

T. W. Dickey
IBM Field Engineering
6811 West 63rd Street
Shawnee Mission
Kansas 66201

C. W. Gilbert
IBM Field Engineering
2929 Cedar Springs Road
Dallas, Texas 75219

L. A. McWilliams
IBM Field Engineering
9045 Lincoln Boulevard
Los Angeles, Calif. 90045

C. G. Kruse
IBM Field Engineering
340 Market Street
San Francisco, Calif. 94119

IBM®

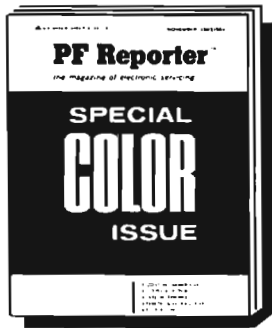

send just  and
I will send you this special
COLOR TV issue of
PF REPORTER

Sam W. Hamer

There's no better way to acquaint you with the invaluable, practical help PF REPORTER offers you month-after-month in your electronics work, than to start your subscription with a copy of the special November Color TV issue for just one cent!

We'll enter your subscription with November and send you the next 11 issues for only \$2.49—regular subscription rate is \$5.00 per year—so you save ONE-HALF!

To see what we mean about the practical value of PF REPORTER, here are just some of the features in the Color TV issue:

Know Your 1967 Color Circuits—a valuable preview of significant new developments and features • **Color Countermeasures**—symptoms and solutions for recurring color TV troubles • **Servicing Bandpass Amplifiers**—fundamentals of this basic color stage • **Color Chaos**—what happens when a chassis gets redesigned • **Notes on Test Equipment**—uses in color servicing • **The Troubleshooter**—answers to perplexing color service problems • **Color TV Training—AND MUCH MORE!**

A single issue of PF REPORTER can bring you information and help worth many times our special low introductory subscription price. And here's your solid guarantee: Subscribe to PF REPORTER today. If you aren't completely satisfied it's the best magazine in the electronics servicing field, just let us know and we'll refund the unexpired portion of your subscription immediately.

SPECIAL HALF-PRICE PF REPORTER INTRODUCTORY SUBSCRIPTION OFFER!

PF REPORTER, Dept. EWR-11
Box 68003, Indianapolis, Ind. 46268

Okay—here's my penny—start my subscription with your Special Nov. Color TV issue, and bill me for \$2.49 for a full one-year term (regular rate is \$5 per year).

\$2.50 enclosed Bill me

Name _____

Firm _____

Address _____

City _____ State _____ Zip _____

CIRCLE NO. 96 ON READER SERVICE CARD

78

Power Inductors (Continued from page 35)

hermetically sealed types offer the greatest amount of protection and best appearance, while having the poorest heat dissipation and higher cost. Many types of construction between these two extremes are available which combine the desired qualities of each. For example, many fully enclosed types of inductors are available which are not hermetically sealed but which have more protection and better appearance than the open-frame types.

The hermetically sealed inductor is completely enclosed in a metal case which has been filled with a suitable compound and sealed by soldering all the seams and openings. Filling material may be wax, pitch, epoxy, or polyester, depending upon the temperature requirements of the item. This type offers maximum protection against mechanical and environmental stresses but is generally larger and heavier than equivalent units of other construction. Molded and encapsulated types offer reasonable protection and are increasing in usage where size and weight are significant in equipment design. Epoxies are prominent as encapsulants, and silicon rubber is often used for high-temperature applications. Encapsulated or molded inductors offer good moisture resistance, mechanical strength, and heat dissipation but are not as impervious to thermal conditions as hermetically sealed types.

Open-frame, varnish-impregnated units are quite common in commercial applications where environmental conditions are not severe. Varnish impregnation offers moderate protection against moisture and climate. Variations of this open construction offer several levels of protection by use of end covers, partial enclosures, etc.

Commercial & Military Specs

MIL-T-27B, "Transformers and Inductors (Audio, Power and High Power Pulse), General Specification for," sets forth minimum standards for inductors used in military equipment. Areas covered by this specification include: materials, design, inspection requirements, case sizes, marking, environmental requirements and testing, and packaging levels. Transformers and inductors supplied to this specification are normally hermetically sealed (grades 1 or 4) or encapsulated or molded (grades 2 or 5). Open-frame types may be purchased to this specification (grades 3 and 6) but are normally used only where further protection will be provided in the equipment, such as encapsulation of sub-assemblies.

Transformers and inductors supplied

to MIL-T-27B are marked with a MIL type number, such as TF4RX01EA. This number indicates the grade, temperature class, life expectancy, family, and case size of the unit. An additional three digits following this type number indicate that the unit is designed to a particular government MS drawing.

Compliance with this specification is mandatory for items supplied for most military equipment, and complete qualification testing must be performed for many contracts.

Commercial standards, although not as strictly followed by individual contractors as the military equivalents, set forth specifications which are generally adhered to by the electronics industry. For power inductors, RS-197 (revision of TR-110-B) covers power filter inductors and RS-181 (revision of TR-127) covers iron-core charging inductors. These particular standards are available through the engineering department of the Electronic Industries Association (EIA).

Specifying Power Inductors

The following ten points should be considered when selecting or specifying inductors for electronic power circuits. Some of these points will be dictated by the electrical requirements of the circuit in which the inductor is to be used, while others will depend largely upon the construction of the equipment and its intended usage.

1. Application and circuit used. For charging inductors, a schematic of the circuit should be made available, while for filter inductors, specifying the type of rectifier circuit (*i.e.*, full-wave bridge, etc.) should be adequate.

2. Inductance and tolerance. Due to the complexity of design and number of variables on inductors carrying direct current, at least 10% tolerance should be allowed. Standard tolerance on off-the-shelf inductors of this type is —20% to +50%.

3. A.c. operating voltage and frequency.

4. Direct current or range of direct-current values that are present in the coil.

5. D.c. resistance and tolerance when necessary to circuit operation.

6. Dielectric strength and/or maximum working voltage.

7. Case type (open frame, encapsulated, etc.).

8. Terminals (wire leads, turret type, lugs, etc.).

9. Environmental requirements, including maximum temperature rise and operating temperature, moisture resistance, thermal shock, vibration and shock, life expectancy, and other applicable factors.

10. Applicable military or commercial specifications. ▲

Linear Integrated Circuits

(Continued from page 26)

avoid the use of large resistors by substitution of transistors. A typical example is the simulation of a constant-current source by use of a transistor in place of a large-value resistor.

(g) When possible, replace a capacitor with a transistor. Fig. 10 shows an example in which coupling between two stages is accomplished by a capacitor in one case and by a transistor in the other. In integrated form, the two-stage amplifier using only transistors is markedly lower in cost than the one that uses a capacitor.

4. Prepare a breadboard design, using parasitic (not circuit-interconnected) IC components for all active devices (transistors and diodes). The parasitic capacitance is simulated by connecting the substrate of the device to the most negative voltage point. The parasitic components that are used must match, in area, those which will appear in the final monolithic design. Because the impurity concentration and distribution employed in the fabrication of the monolithic circuit can have a marked effect upon the characteristics, it is also important that all parts of the process for the parasitic components and the process to be used for the fabrication of the circuit be identical.

After these steps are completed, a circuit can be released for layout, mask preparation, and fabrication. After fabrication, the circuit is subjected to a complete d.c. analysis. The limits used for this analysis are determined in advance by the circuit-design engineer. After successful completion of the static tests, the circuits are then subjected to a complete dynamic performance

Fig. 10. Circuit (A) employs a transistor in place of the capacitor shown in (B).

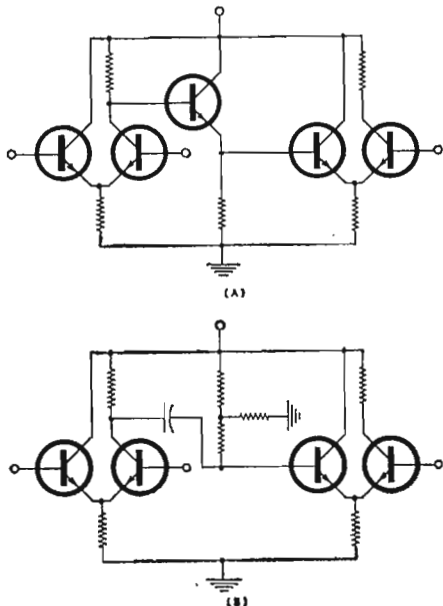

The ideal base/mobile combination for CB radio

FOR BASE STATIONS where 117V 60 cycle AC current is available...



The Low-Cost RCA Mark VIII and Mark NINE

- 9 crystal-controlled transmit and receive channels
- Tunable receiver for reception of 23 C-B channels, dial marked in both channel numbers and frequency
- Exceptionally good voice reproduction
- Highly selective superheterodyne receiver with one RF and two IF amplifier stages
- Electronic switching—no relay noise or chatter
- Illuminated "working channel" feature
- Light and compact - only 3¾ inches high, weighs only 9 pounds with mike
- Improved Automatic Noise Limiter

Plus these EXTRA features in the Mark NINE

- Combination "S" Meter (indicates the relative strength of incoming signal) and Relative RF Output Meter (indicates relative strength of signal being transmitted)
- Spotting Switch. Permits precise manual tuning of receiver without use of receiver crystals
- External Speaker Jack. Lets you connect an external speaker to set, so that incoming calls can be heard in remote locations

Mark VIII: \$99.95* Mark NINE: \$114.50*

*Optional distributor resale price.

FOR MOBILE UNITS where low power consumption is important...



The all-solid state MARK 10

- All silicon transistors assure low power consumption, dependable communication at temperatures from -23° to $+130^{\circ}$ F
- Compact, lightweight. Fits easily under dash of any car or truck. Only 3¾" high, 5¾" deep, 8½" wide. Weighs less than 4½ pounds
- 12 crystal-controlled transmit and receive channels with illuminated channel selector
- Combination "S" Meter and Relative RF Output Meter
- Operates from 12-volts DC power source (positive or negative ground)
- Crystal-controlled double conversion, superheterodyne receiver provides frequency accuracies greater than 0.004%
- Separate AGC amplifier eliminates blasting and overloading, minimizes fading
- Six-stage IF bandpass filter for maximum selectivity without ringing
- Low-distortion, series-type noise limiter with automatic threshold adjustment
- Receiver power regulated for maximum stability
- Acoustically designed cabinet with audio characteristics shaped for maximum intelligibility
- External speaker jack (de-activates internal speaker)

Mark 10: \$189.95*

*Optional distributor resale price.

See them at your Authorized RCA CB Radio Distributor. Look for stores displaying this symbol.



RCA ELECTRONIC COMPONENTS AND DEVICES, HARRISON, N. J.

The Most Trusted Name in Electronics

CIRCLE NO. 93 ON READER SERVICE CARD

THE FALL 1966 EDITION OF THE EXCITING ELECTRONIC EXPERIMENTER'S HANDBOOK IS ALL-NEW, PACKED WITH THE MOST FASCINATING CONSTRUCTION PROJECTS EVER AND READY FOR YOU RIGHT NOW!



You'll build a smoke alarm for your home . . . a TV picture tester and rejuvenator . . . a \$10 solid-state 6-watt amplifier . . . a headlights-on alarm . . . a watchdog mobile monitor . . . a failsafe transistor power supply . . . a 99c speaker enclosure . . . and over 20 other challenging do-it-yourself construction projects!

Each project is described from start to finish in clear, concise, easy-to-follow language. Add fully detailed schematics, illustrations and parts lists—plus dozens of professional how-to tips and techniques—and you've got all the ingredients for some of the most unique electronics items you've ever seen . . . or put together with your own two hands!

Including units for: your home • audio/stereo/hi-fi • your car • SWL-CB-Ham • test equipment

Whether you keep the valuable units you'll build, or sell them for a profit (they'll cost you next to nothing to construct), the Fall 1966 Electronic Experimenter's Handbook is guaranteed to increase your over-all electronics proficiency and provide you with hour after hour of sheer fun!

And note this special bonus feature: "Project Choose"—an exclusive report on electronics correspondence and resident schools!

Over 148 pages of fascinating electronics in all. Don't miss it! Use the coupon below and order your copy today!

only Got the message?
\$1.25 Get the scissors!

GET THE HANDSOME LEATHERFLEX-BOUND EDITION for just \$3 POSTPAID!

The Fall 1966 Electronic Experimenter's Handbook is also available in a splendid deluxe edition: Rugged leatherflex cover provides lasting protection yet is softly textured and gold embossed for the look of elegance. A collector's item—a superb addition to your electronics bookshelf. And it's yours, for just \$3 postpaid, when you check the appropriate box on the order form.

**ZIFF-DAVIS SERVICE DIVISION
DEPT. EEH-F
589 Broadway • N.Y., N.Y. 10012**

OK! Send me the all-new Fall 1966 Electronic Experimenter's Handbook.

\$1.25 enclosed, plus 15c for shipping and handling. Send me the regular edition. (\$1.75 for orders outside the U.S.A.)

\$3.00 enclosed. Send me the Deluxe Leatherflex-bound edition, postpaid. (\$3.75 for orders outside the U.S.A.) Allow three additional weeks for delivery.

name PLEASE PRINT EW-116

address

city

state zip code

PAYMENT MUST BE ENCLOSED WITH ORDER

Yes, I did miss the big Spring 1966 edition. So please rush it to me right now! I want the regular edition Deluxe Leatherflex-bound edition. (Prices same as above.)

Miss the Spring '66 Handbook?

analysis to ensure that the unit complies with the original "black-box" specifications.

Production Testing

Because an integrated unit performs a circuit or multiple-circuit function, testing can be a significant portion of the cost. However, a large part of the testing cost can be avoided by use of a.c. or dynamic specifications which permit performance deviations within the normal process variables. Under such conditions, an integrated circuit can generally be evaluated completely by means of static or d.c. testing. These static tests are fast (typical automatic-equipment static test rates are on the order of 30 to 60 tests per second) and provide a high probability that the circuit will perform properly under dynamic conditions because the components of the integrated circuit are frequently more sensitive to d.c. than a.c. evaluation.

There are obvious exceptions for which d.c. tests cannot assure compliance with an a.c. specification, particularly when capacitor coupling is used. In such cases the pellet is d.c.-probed before dicing at internal points and then may be a.c.-tested after the mounting and bonding have been completed.

The Future

The most important single development in linear integrated circuits over the next few years should be the design of standard types and the acceptance of these types by equipment manufacturers. Large volume requirements with extreme emphasis on low cost will encourage the development of special circuits with multi-function uses, particularly in consumer and some limited industrial applications. Technological developments will extend the frequency range through u.h.f., and large improvements will be forthcoming in low-noise applications at both high and low frequencies. Extension into greater power-handling capability will, to a large extent, be determined by economic considerations. Combinations of MOS and bipolar transistors offer some unique technical advantages and will become a part of the standard types offered by more manufacturers.

The most significant contribution that integrated circuits will make to equipment of the future is that more complex instruments will be generated because one or more orders of magnitude of electronic functions will be purchased for the same cost. In addition, the improvement in reliability will permit such designs. As a result, equipment manufacturers will be stimulated to design products which today are neither practical nor economically feasible. ▲

Designing Hi-Fi Amplifiers

(Continued from page 50)

ture capabilities of the silicon transistors, the performance of the amplifiers remains essentially the same over a wide variation in ambient temperature.

Fig. 5A shows a schematic of a practical 10-watt quasi-complementary audio amplifier. This circuit employs the same stability techniques as those used in the circuit of Fig. 1. Two 1N3754 diodes are used in the input of the driver stage to compensate for the effect of high-temperature variations of the output transistors. Two 1-ohm resistors are placed in the output stage to provide the degeneration required for circuit stability. These resistors are shunted by 1N3193 diodes to reduce losses when the amplifier is operated at full rated output power.

The use of direct-coupled stages and local d.c. feedback results in very stable quiescent operation at ambient temperatures up to 71°C. With an over-all negative feedback of 5 dB, the amplifier has a response that is flat within 1 dB from 15 to 20,000 Hz. Performance curves for the 10-watt amplifier are shown in Figs. 5B, 5C, and 5D.

25-Watt, Class-AB Audio Amplifier

Fig. 6A shows the schematic of a 25-watt a.c./d.c. transformer-coupled audio amplifier intended primarily for public-address systems and other applications for which economy and flexibility with respect to load impedance are important considerations. The high breakdown voltage of the silicon power transistors used in the output and driver stages permit the amplifier to be operated directly from a 120-volt a.c. or d.c. line. The negative-voltage terminals of the amplifier (*i.e.*, circuit ground) is isolated from chassis ground by a 0.22-megohm resistor to reduce the risks of electrical shock. The signal input should be transformer-coupled to the power amplifier to avoid shock hazard from the signal-source ground. A 0.1-μF capacitor provides a low impedance connection between circuit ground and chassis ground at r.f. frequencies to prevent high-frequency oscillations.

Each driver transistor is connected to the associated output transistor in a Darlington arrangement; the output is transformer-coupled to the speaker. Drive-signal phase inversion is provided by a transistor phase-splitter circuit. The small amount of forward bias required for class-AB operation is provided by the 180,000 and 510-ohm resistors and the 1N3754 diode. The diode also provides the temperature compensation required so that the quiescent current will remain relatively constant for wide variations in temperature. With the 10 dB of over-all

feedback from the output to the emitter of the first stage, the amplifier has an input impedance of 2500 ohms. Performance curves for the 25-watt unit are shown in Figs. 6B, 6C, and 6D.

70-Watt, Class-AB Audio Amplifier

Fig. 7A shows the schematic of a high-quality 70-watt direct-coupled series-output audio amplifier in which unique techniques are used to obtain stable and reliable performance. The three 1N3754 diodes in the driver stage are thermally connected to the output transistor heatsinks so that the thermal feedback required to maintain a preset 20 milliamperes of quiescent output current is obtained at all case temperatures up to 100°C. Small-value emitter resistors are employed in the output stage because additional stability is not necessary and output losses must be held to a minimum. A 1N1612R diode is placed in the emitter of one output transistor to cancel the offset voltage of the input transistor and thereby maintain the quiescent output voltage near zero.

Short-circuit protection is provided by the 0.27- and 0.33-ohm emitter resistors and the zener diode. If any condition exists which will cause higher-than-normal current (5 amperes) to flow through these resistors, the voltage potential across the zener diode will be such that the diode conducts in the forward direction during the negative output half cycle and exceeds the diode breakdown voltage during the positive half cycle. In this way, the driver is clamped below the 5-ampere level, and no increase in output current above this value is allowed. The drivers and output transistors, therefore, are protected from high currents and excessive power dissipation that may result from a reduced load resistance or, in the worst case, a short-circuit. In addition, a 100°C thermal cut-off is attached to the output transistor heatsink which will turn off the amplifier when these abnormal conditions cause sustained higher-than-normal output dissipation.

The frequency response of the amplifier is flat within 1 dB from 5 to 25,000 Hz. The input sensitivity of the amplifier is 0.8 volt r.m.s. for full rated output. The input resistance is 100,000 ohms. The performance curves for the 70-watt amplifier are shown in Figs. 7B, and 7D.

(Editor's Note: The three amplifier circuits shown in this article are not intended as construction projects. We have no information on sources for any of the special parts required. Rather the circuits were included to illustrate the various design principles discussed in this three-part series of articles.) ▲



Your new copy is waiting

FREE! For fun and pride in assembly, for long years of pleasure and performance, for new adventures in creative electronics mail the coupon below and get Conar's brand new catalog of quality do-it-yourself and assembled kits and equipment. Read about items from TV set kits to transistor radios . . . from VTVM's to scopes . . . from tube testers to tools. And every item in the Conar catalog is backed by a no-nonsense, no-loopholes, money-back guarantee! See for yourself why Conar, a division of National Radio Institute, is just about the fastest growing entry in the quality kit and equipment business.

CONAR

MAIL THIS COUPON NOW

CONAR 3939 Wisconsin Ave., Washington, D.C. 20016

MB6C

Please send me your new catalog.

Name _____

Address _____

City _____ State _____ Zip Code _____

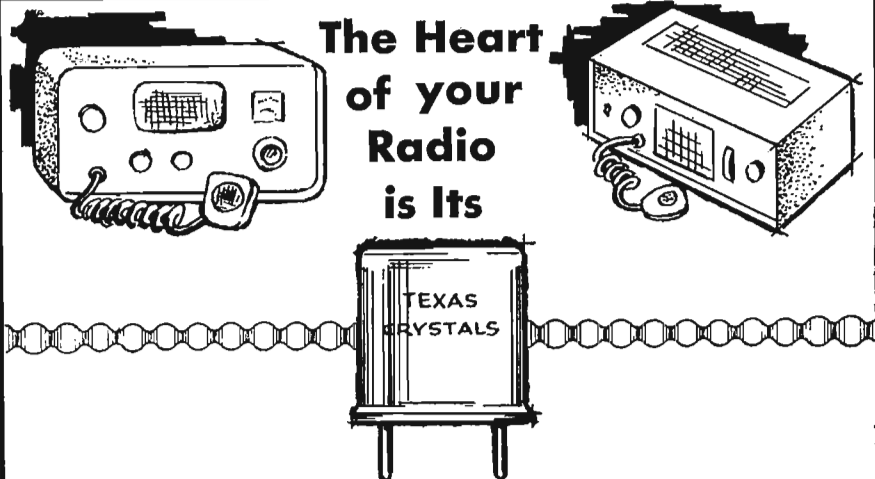

INSIST ON CQC*

*Controlled Quality Crystals available only from Texas Crystals dealers. Extensive precision testing throughout manufacture enables Texas Crystals to unconditionally guarantee their frequency control crystals. Use of Texas Crystals in space program and by other governmental agencies is evidence of the quality you can count on.

If your dealer can't supply your needs, send his name with your request for catalog to our plant nearest you.



TEXAS CRYSTALS

1000 Crystal Drive
Fort Myers, Fla. 33901
Phone: 813-936-2109

4117 W. Jefferson Blvd.
Los Angeles, Calif. 90016
Phone: 213-731-2258



Division of Whitehall Electronics Corp.

CIRCLE NO. 84 ON READER SERVICE CARD

SCOTT



SCOTT'S NEW ONE-AFTERNOON TUNER KIT DELIVERS AMAZING FET PERFORMANCE

Now you can get factory-wired performance from a kit that takes only one afternoon to build! Scott's new LT-112B is the only kit with Field Effect Transistor circuitry*, enabling you to enjoy more stations more clearly. Interstation Muting Control effects complete quiet between FM stations . . . oscilloscope output allows laboratory-precise correction for multipath distortion.

"Scott's LT-112 . . . is one of the finest FM stereo tuners we have tested and it is easily the best kit-built tuner we have checked . . . Because of its simple construction and trouble-free nature, it is a logical choice for anyone who wants the finest in FM reception at a most remarkable price." HiFi/Stereo Review.

LT-112B specifications: Usable sensitivity, 1.8 μ V; Cross modulation, 90 dB; Stereo separation, 40 dB; Capture ratio, 2.5 dB; Price, \$189.95. *Patents pending

For complete information on the Scott LT-112B, send for your free copy of Scott's 16-page full-color illustrated Guide to Custom Stereo.

FREE! 1967 SCOTT GUIDE TO CUSTOM STEREO

Here are 16 colorful, information-packed pages on Scott stereo components . . . receivers, tuners, amplifiers, speakers . . . for 1967. Fact-filled, fully-illustrated articles show you what to look for when buying solid-state components, how stereo works, how to create your own home music system.

NAME _____

ADDRESS _____

CITY _____

STATE _____

ZIP _____

Scott . . . where innovation is a tradition



H. H. Scott, Inc.,
111 Powdermill Road, Maynard, Mass.
Export: H. H. Scott, Inc., Maynard, Mass.

Prices slightly higher west of Rockies. Subject to change without notice.

CIRCLE NO. 89 ON READER SERVICE CARD

Square-Wave Generator

(Continued from page 43)

the base of this transistor to the emitter momentarily and note that the collector voltage should rise as the other side becomes conducting. Do this several times, and if results are consistent, the flip-flop is operating. If pulses had been observed at point A, the trouble would have been in the trigger network consisting of C3, D1, D2, and D3. Diode polarities and bad capacitors are the usual causes of trigger trouble.

Once square waves are being produced, audio equipment can be tested by any of the well-known methods. If the scope used with the generator does not have d.c.-coupling or a low-end response to below 5 Hz, it will affect the waveshape, and this should be taken into account before some possibly innocent amplifier is accused of having poor low-end response.

At the other extreme of the spectrum, rise time and overshoot measurements will allow equipment to be judged to beyond 100 kHz.

For great accuracy, either a frequency counter or an accurate audio signal generator used in the well-known Lissajous pattern system can be employed to calibrate R2. In lieu of these, a procedure having intermediate accuracy can be performed as follows:

1. Adjust the scope sweep so that a single low-voltage 60-Hz sine wave (line frequency) applied to the vertical input occupies the bulk of the calibrated scope graticule. Adjust the

scope controls so that the sine wave is stationary and its zero points cross noted graticule marks.

2. Remove the 60-Hz signal from the scope and substitute the square-wave generator output. Adjust R2 so that one complete square wave now occupies exactly the same space as the 60-Hz sine wave. This is the 60-Hz setting of R2 and this point should be so marked.

3. Reset the scope sweep speed so that three cycles of 60-Hz square wave now occupy the same space as the single one did previously. Adjust R2 so that one square wave now occupies this space. This is the 20-Hz setting of R2. If R2 will not reach 20 Hz, reduce the value of R3 in 100,000-ohm steps until it does.

To calibrate the higher frequencies, "walk up" the audio spectrum as follows:

1. Fill the graticule space with a 20-Hz square wave. Adjust R2 for two square waves in this space. This is the 40-Hz setting.

2. Change the scope sweep speed for one 40-Hz square wave on the graticule. Adjust R2 for two square waves. This represents the 80-Hz setting.

3. Continue the above procedure to produce settings at 20, 40, 80, 160, 320, 640, 1280, 2560, and 5120 Hz, and at 10.240 and 20.480 kHz at the end of the R2 rotation. Unfortunately, in spite of the use of logarithmic potentiometer for R2, the frequencies will tend to bunch up at the maximum resistance end of the pot. ▲

SPEAKER EFFICIENCY AND AMPLIFIER POWER

By R.S. OAKLEY, Jr.

IN the table below, the second column refers to the percent of amplifier power converted to acoustic power by the loudspeaker. Direct radiators in small cabinets will normally be about 0.5% to 2.0% efficient; direct radiators in large cabinets will be about 2.0% to 10% efficient. Horn-loaded systems will be about 10% to 50% efficient.

The columns marked "Amplifier Power" refer to continuous power ratings (per channel) of amplifiers. It is assumed that 0.25 acoustic watt per channel will result in natural sound levels. For instance, an amplifier rated at 25 clean continuous watts per channel would normally be sufficient to drive speakers of 1.0% efficiency. In a room

that is much larger than normal or in a room with very "dead" acoustics, 100 watts might be needed.

The column marked "Music" takes into account the fact that peak power in music signals will be from ten to one hundred times greater than the normal average power. In a larger-than-normal "dead" listening room, a speaker of 10% efficiency might have to handle as much as 10 watts on very loud orchestral peaks. But assuming a peak-to-average ratio of only 10 dB, the average power of a music signal fed to the speaker would not normally exceed about .25 watt.

(Note: This material was derived from information supplied by Acoustic Research, Inc.) ▲

	SPEAKER EFFICIENCY	AMPLIFIER POWER		MUSIC
Very low	0.5%	50	200	5.0
Low	1.0%	25	100	2.5
Medium low	2.0%	12.5	50	1.25
Medium	5.0%	5.0*	20	0.5
Medium high	10%	2.5*	10*	0.25
High	20%	1.25*	5.0*	0.125
Very high	50%	0.5*	2.0*	0.05

*Commercially available amplifiers rated at less than 10 watts per channel may have excessive distortion for wide-range music applications. On the other hand, some amplifiers rated at more than 10 watts per channel may have too much hum or noise for high-efficiency speakers.

JAPANESE IC'S

JAPANESE semiconductor manufacturers are now deeply involved in the development of integrated circuits.

Afraid that overseas patents may restrict Japanese manufacturers, the Japanese Government is presently allocating \$80,000 per year to six semiconductor manufacturers: *Fujitsu Ltd.*, *Nippon Electric Co. Ltd.*, *Mitsubishi Electric Corp.*, *Tokyo Shibaura Electric Ltd. (Toshiba)*, *Oki Electric Ltd.*, and *Hitachi Ltd.* for integrated circuit research and development.

These government fears stem from the Japanese patent applications of *Fairchild Co.*, *Texas Instruments*, and *General Electric*. In the opinion of some Japanese manufacturers, the American IC's now constitute a very serious menace to the Japanese electronics industry.

The present standing of the bulk of Japanese IC manufacture is as follows:

Fujitsu Ltd. Computer manufacturer. Mostly thin-film hybrid digital.

Hitachi Ltd. Computer manufacturer. Mostly digital types. Latest IC contains 15 transistors and 13 resistors.

Kyodo Electronic Labs. Inc. This organization was established a few years ago by cooperation of the five largest component manufacturers in Japan: *Toko Inc.* (coils, ceramic capacitors, resistors, mechanical filters, memory matrices); *Nippon Chemical Condenser Co. Ltd.* (capacitors, recording tapes); *Koden Electronics Ltd.* (radio direction finders, loran systems); *Alps Electric Co. Ltd.* (switches, TV tuners); and *Pioneer Electronic Corp.* (speakers, hi-fi systems). The lab is devoted to the development of IC's and has produced a high-speed hybrid flip-flop and several other digital types. They are looking into IC's for use by the member firms. Incidentally, the chief engineer is an American.

Matsushita Electronics Corp. Has a close connection with Dutch *Philips* and is developing a linear IC for low-level hearing-aid use.

Mitsubishi Electric Corp. Has developed a hybrid linear IC for audio use, called the "Molelectron". They also make digital thin-film hybrid types.

Nippon Columbia in conjunction with *Towa Capacitor* have produced an IC using four transistors, ten capacitors, and twelve resistors.

Nippon Electric Co. Ltd. One of the first Japanese IC manufacturers. Their latest is a digital device having four capacitors, four resistors, and two transistors.

Oki Ltd. Computer manufacturer. Developing strictly digital types.

Sony Corp. Developing linear IC's. Their latest is a two-stage direct-coupled wide-band amplifier.

TEAC[®] (TEE-AK) 3 MOTORS 4 HEADS

The TEAC R-1000 is a professional quality stereo tape recorder with automatic reverse system. 3 motors make it a professional type recorder. 4 heads and automatic reverse make long playing possible. This model is the ultimate in quality stereo performance. It gives you professional quality for home listening enjoyment.

Other features include stereo echo effects, safety switch for preventing accidental erasings, micline mixing, simultaneous playback and recording on separate tracks and automatic shut-off.
LESS THAN \$450

TEAC[®]

**INTERCONTINENTAL
SEAWAY
PRODUCTS
COMPANY**

5400 E. 96th Street
Cleveland, Ohio 44125

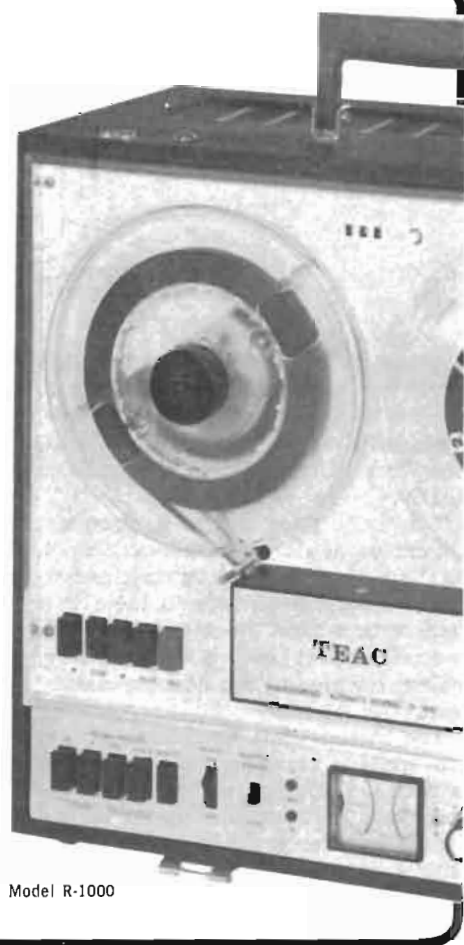

Model R-1000

CIRCLE NO. 110 ON READER SERVICE CARD

**WORLD'S
FINEST
5-CORE
SOLDER**

**ERSIN
MULTICORE
NEW EASY
DISPENSER
PAK ONLY 69¢**

BUY IT AT RADIO-TV PARTS STORES

F.C.C. LICENSE TRAINING

by correspondence

The best there is!

Ask about our

**MONEY-BACK
WARRANTY**

Approved for
veterans and servicemen

For free information, write:

Dept. 66-S
**GRANTHAM SCHOOL
OF ELECTRONICS**
1505 N. Western Ave.
Hollywood, Calif. 90027

BOOK REVIEWS

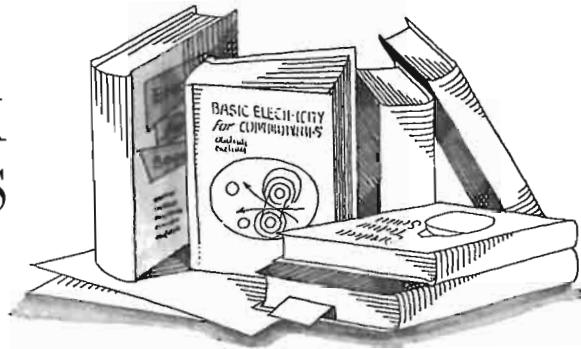

"OPTICAL SCANNING FOR THE BUSINESS MAN" by R. Dyer, J.E. Hoelter, J.A. Newton & Assoc. Published by *Hobbs, Dorman & Co., Inc.*, 441 Lexington Ave., New York, N.Y. 10017. 190 pages. Price \$14.50.

This book grew out of a classroom assignment at Harvard Business School. As the authors worked on their assignment it became obvious to them that there was a need for a non-technical, in-depth report on optical scanning, written for men at the decision-making level.

The material has been divided into five sections covering an introduction to optical scanning (outline of the report, brief history, and major conclusions); machine technology (document control, scanning techniques, logic, and machine classifications); scanners in data processing systems (turnaround source document systems, fan source document systems, type-scan *versus* keypunch, other system considerations, and implementation); industrial and governmental applications; and future trends (implications of standard font, alternative inputs, and handwriting readers).

The text is quite lavishly illustrated and it is presented in easy to assimilate form.

"ENGINEERS' RELAY HANDBOOK" compiled by the National Association of Relay Manufacturers. Published by *Hayden Book Company, Inc.*, New York. 293 pages. Price \$11.95.

This volume has been produced by NARM in cooperation with 32 of the major relay manufacturers. It provides engineers, management personnel, and technicians with a comprehensive source of information on operating principles, properties, performance characteristics, application requirements, specifications, and testing.

While technology is covered to some extent, the major emphasis in this book is on the practical. One particularly valuable chapter deals with the various ways in which a relay for a particular service can be specified to obtain desired performance.

The appendix contains extensive information valuable to engineers when designing relays into circuits or systems.

It also includes a comprehensive bibliography which will be invaluable for user, designer, or manufacturer.

"HANDBOOK OF STROBOSCOPY" by Frederick Van Veen. Published by *General Radio Company*, West Concord, Mass. 112 pages. Price \$1.00. Soft cover.

Although this handbook is written around *General Radio's* line of stroboscopes, much of the material and many of the techniques described can be applied to stroboscopes in general.

The text describes modern electronic stroboscopes, their accessories, and their application in speed measurement, motion observation, and high-speed photography.

Chapter 6, a 42-page section, covers the many applications for strobes—indexed to one or more of the 37 uses discussed in the chapter. The entire book is filled with photos, line drawings, pictorials, graphs, charts, and schematics, amplifying the various points under discussion.

"OSCILLOSCOPE MEASURING TECHNIQUE" by J. Czech. Published by *Philips Technical Library*. Distributed in U.S. by *Springer-Verlag New York Inc.*, 175 Fifth Ave., New York, N.Y. 10010. 613 pages. Price \$15.80.

This is a revised, expanded, and updated version of the author's "Cathode Ray Oscilloscope" which received a warm reception a number of years ago.

The text material is divided into four parts and 33 chapters. The first part deals with the instrument itself and covers the construction of the CRO and CRT, the power-supply unit, time-base unit, deflection amplifiers, while Part II covers the general measuring technique—including setup and preliminary adjustments, amplitude measurements, null-indication in a.c. bridge circuits, the electronic switch, the uses of intensity modulation, phase measurements, frequency measurements, and rise-time measurements.

Part III is devoted to a practical discussion of various examples of scope applications, while Part IV deals with the problems of photographic recording and large-picture projections of oscillograms.

Although the text is oriented toward

British equipment, it remains an excellent reference handbook for all those who work with cathode-ray oscilloscopes and their accessories.

"AUDIO SYSTEMS" by Julian L. Bernstein. Published by *John Wiley & Sons, Inc.*, New York. 404 pages. Price \$4.50. Soft cover.

This book is an outgrowth of the various audio courses the author has given at *RCA Institutes* and is designed as a textbook for electronics students, technicians, or engineers who need more information on all types of audio systems. Users of this book will need algebra, trigonometry, and a little calculus since the treatment is mathematical.

The text is divided into eight chapters and an introduction and covers signals, noise, and distortion; decibels and volume units; attenuators; mixing and bridging systems; amplifier systems; recording systems; equalizers; and audio transducers. As is usual in textbooks, there are problems appended to each chapter with answers given for the odd-numbered problems. The text is amplified by a generous use of schematics, graphs, oscillograms, line drawings, and photographs. It is also suitable for use as a self-instruction text.

"HANDBOOK OF RELAY SWITCHING TECHNIQUE" by J. Appels & B. Geels. Published by *Philips Technical Library*. Distributed in U.S. by *Springer-Verlag New York Inc.*, 175 Fifth Ave., New York, N.Y. 10010. 316 pages. Price \$10.80.

The tremendous growth in automated processing and the widespread adoption of the ubiquitous computer has created a demand for switching specialists. As the authors point out, not only is there a scarcity of skilled workers but there is a paucity of available information to eliminate this shortage. This volume is an attempt to fill the gap.

Although the book is primarily concerned with the basic elements of relay circuitry, much of the information is also applicable to electronic switching techniques. In many cases the theoretical information is illustrated by means of practical examples. Self-checking questions at the end of each chapter permit the user to test his grasp of the material discussed.

For those lacking the requisite background, the authors have provided a chapter on the elements of switching algebra—the understanding of which is valuable for those involved with electronic switching techniques.

As a reference work as well as a textbook, this volume should prove a worthwhile addition to any technical library. ▲

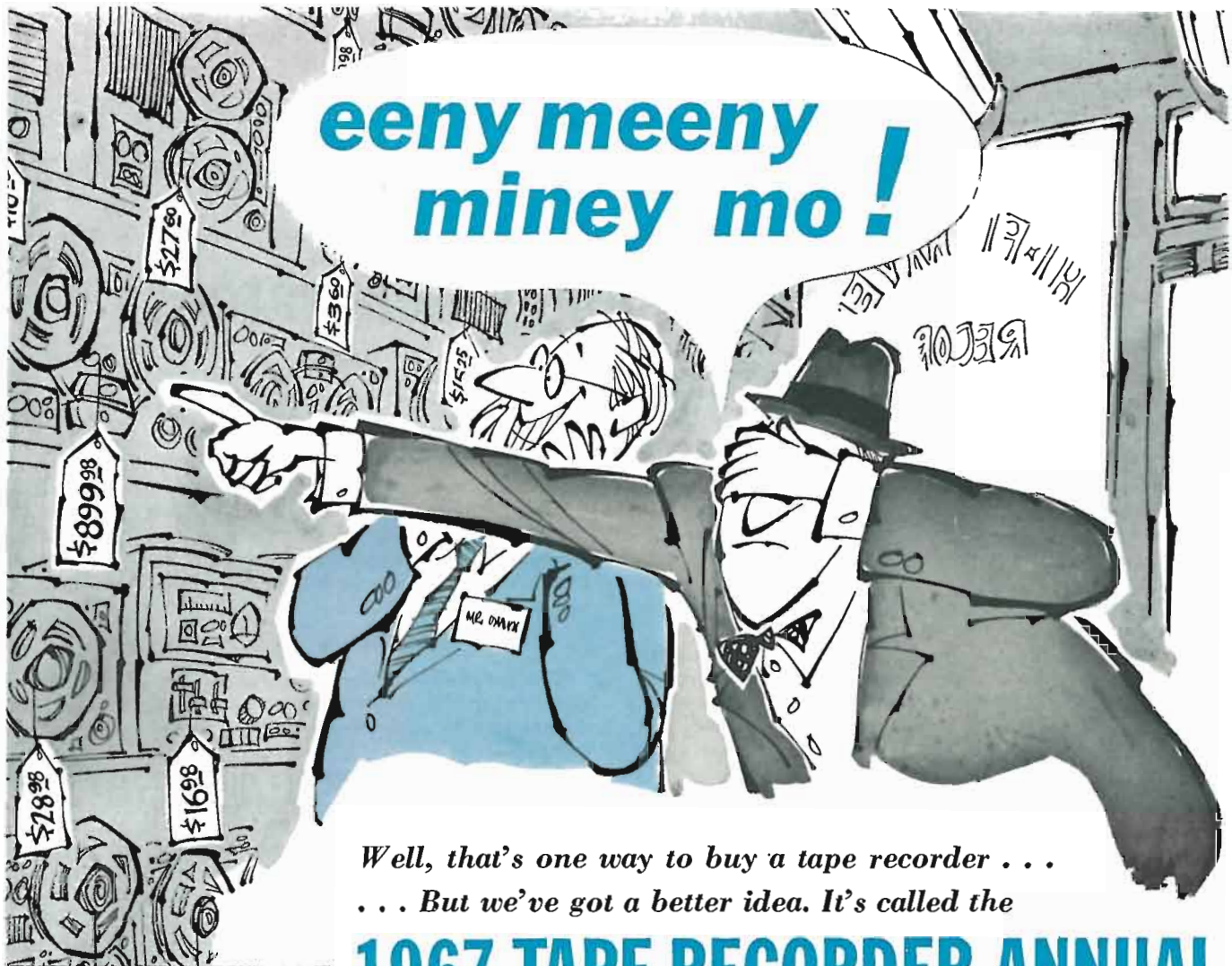

*Well, that's one way to buy a tape recorder . . .
 . . . But we've got a better idea. It's called the*

1967 TAPE RECORDER ANNUAL

—your guide to the tape recorder brands and models on the market right this minute. The only buyer's guide of its kind available in the field!

Oh, it may not be as exciting as the "blind-man's-bluff" method, but it sure is a lot less costly . . . and less disappointing. This encyclopedic volume will arm you with all the essential data you need to go out and pick the very best recording equipment in your price range. Without a qualm. Without an "after-you-get-it-home" let-down. Without a blindfold!

You'll find more than 132 pages of full information on over 250 models from virtually every major manufacturer. Stereo and mono. Portables and full home installations. Even video tape recorders and the new car cartridge machines! All the model numbers,

specifications, dimensions and prices. Almost 200 photos. Every vital statistic you need to compare the newest recorders and select the one that will bring you the greatest value for your dollar!

And that's only half the story. After you buy your recorder, turn to the articles on microphone selection, basic tape recorder theory, taping off the air, creative editing or the special accessories section. You'll get expert tips by the dozens. Ten complete features covering every aspect of tape recording. All designed to give you better performance, greater versatility and a lot more fun from your tape recorder!

How much for this indispensable treasury of sound advice? Just \$1.25. A small price for a big eye-opener.



GET THE HANDSOME LEATHERFLEX-COVERED EDITION FOR \$3 POSTPAID:

THE 1967 TAPE RECORDER ANNUAL is also available in a splendid deluxe edition. Rugged Leatherflex cover provides lasting protection yet is softly textured and gold-embossed for the look of elegance. A collector's item—a superb addition to your permanent reference library. And it's yours, for just \$3 postpaid, when you check the appropriate box on the order form.



Ziff-Davis Service Division, Dept. TRA
 589 Broadway, New York, N.Y. 10012

Please send my copy of the 1967 TAPE RECORDER ANNUAL as checked below:

- I am enclosing \$1.25 plus 15c for shipping and handling for the Regular Edition. (\$1.75 for orders outside U.S.A.)
- I am enclosing \$3.00. Please send me, postpaid, the Leatherflex-covered Deluxe Edition. (\$3.75 for orders outside U.S.A.) (Please allow 3 additional weeks for delivery of the Deluxe Edition.)

name _____ (please print) EW-116

address _____

city _____ state _____ zip code _____

This instrument is used when fast, accurate frequency response measurements are needed in the laboratory, on the production line, and at the service bench. Sweep methods and parameters used by most manufacturers are covered.

Selecting A Sweep Frequency Generator

By SAMUEL C. ALLEN / Supervisor, Quality Assurance Engineering
Jerrold Electronics Corp.

WHEN the need arises for a fast, accurate method of making frequency-response measurements, whether in the laboratory, on the production line, or at the service bench, a sweep frequency generator is usually chosen to fill the assignment. But a look through several manufacturers' catalogues will indicate that many types of sweep generators are available, each having its own distinct advantages and disadvantages.

The ability to select the correct instrument for a particular application requires a knowledge of the theory, operation, and descriptive terms concerning sweep generators. This article will explain in general the sweep methods and parameters used by most instrument manufacturers who offer sweep equipment.

A sweep frequency generator is a device employing an oscillator whose output frequency is varied through a particular band. The rate at which the frequency excursion of the sweeping oscillator occurs is determined by a time-base generator.

Fig. 1 is a block diagram of a simple sweep generator illustrating the function of the time-base generator and sweep oscillator as well as the leveling amplifier whose job it is to maintain the oscillator output constant under varying loads and at different sweep bandwidths.

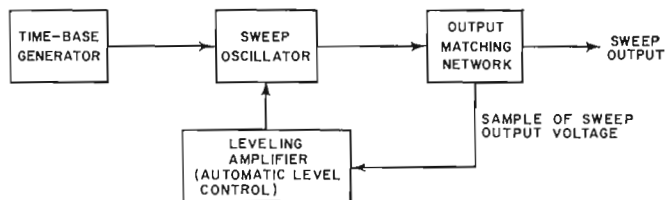
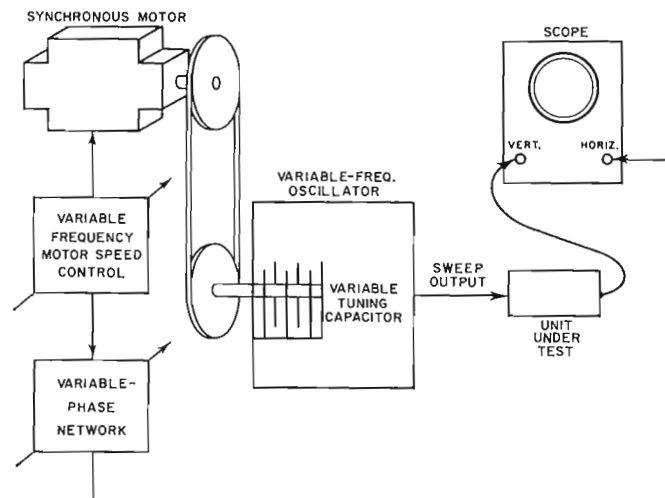

Fig. 1. Block diagram of basic sweep frequency generator.

Fig. 2. Principle of the motor-driven sweep generator.



By connecting a sweep generator to a mechanical recorder or to an oscilloscope, measurement of frequency response can be made quickly and accurately. The numerous benefits of sweep techniques over methods requiring point-to-point voltage vs frequency plots make sweep techniques desirable for qualitative and quantitative measurements.

Motor-Driven Sweep Generator

The motor-driven device shown in Fig. 2 is a sweep generator in the simplest form. By studying its operation, we are able to apply these fundamentals to more complex equipment.

The motor-driven sweep uses an electric motor to turn the tuning capacitor of a variable frequency oscillator throughout the oscillator's range. This causes the oscillator output frequency to vary from minimum to maximum frequency and then back to its lowest frequency again as the motor turns the tuning capacitor through its range. Whether the variable frequency oscillator operates in the audio, r.f., or microwave range, sweeping action will take place.

The rate at which the sweeping oscillator repeats its cycle from the lowest frequency to the highest and back again is dependent upon the motor speed. Thus, a slower motor speed results in a slower sweep repetition rate.

To observe the output frequency response of the motor-driven sweep, a scope is connected so that the horizontal scope speed is synchronized with that of the motor, and the vertical scope amplifier is connected to the generator output. The scope presentation will be a frequency vs time response of the generator output as the generator is driven through its frequency range. Note that observation of generators whose frequencies are above the range of the scope vertical amplifier must be accomplished by detecting (demodulating) the signal before applying it to the scope.

Synchronization of the horizontal scope speed with the motor speed is established through a phase-shifting network which allows the forward and return sweep traces to be superimposed on the scope screen, thereby giving a linear frequency vs time display.

Mechanical-Type Sweep Generator

At this point, it should be noted that sweeping action may be accomplished by either electromechanical or by all-electronic methods.

The most frequently used mechanical sweep technique employs a vibrating inductor or capacitor, sometimes called a wobblator.

Figs. 3 and 4 show a refinement of the motor-driven sweep in which the motor has been replaced by a small speaker-like device which has its diaphragm specially constructed to support a set of capacitor plates. These plates mesh with rigid plates, forming a variable capacitor.

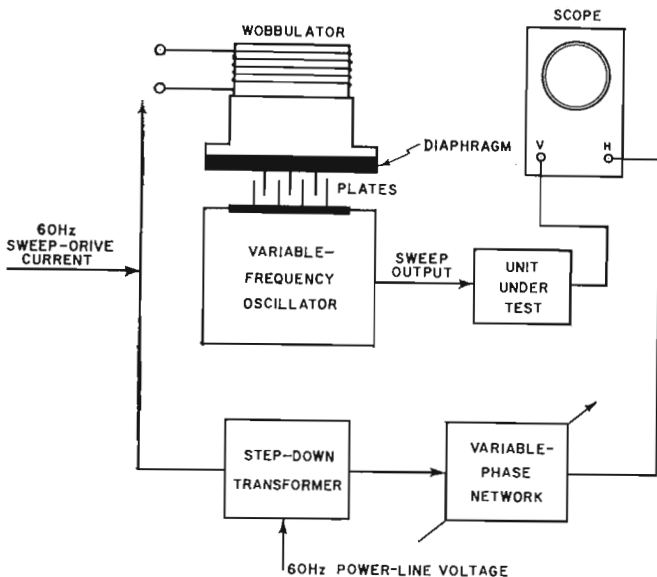

Fig. 3. Principle of the wobbulator-driven sweep generator.

In order to better understand this type of sweep generator, a voice-coil-driven capacitor is substituted for a fixed capacitor in the tank circuit of the 100-MHz oscillator in Fig. 5. When the capacitor plates of the wobbulator are fully meshed (causing maximum capacitance across the tank coil), the oscillator frequency is driven below 100 MHz. The oscillator frequency will be tuned above 100 MHz when the wobbulator plates are unmeshed. Neglecting stray circuit capacitance, the range of frequencies the oscillator will sweep over is determined by the circuit inductance and the maximum and minimum values of capacitance presented by the wobbulator capacitor.

By applying a 60-Hz current to the wobbulator, sweeping action takes place as the capacitor plates are vibrated at a 60-Hz rate. Increasing the amplitude of this 60-Hz current increases the mechanical excursion of the wobbulator diaphragm; thus, the minimum and maximum values of capacitance are extended, resulting in wider sweep bandwidth. Hence, frequency bandwidth is a function of the amplitude of the modulating signal.

A variable d.c. current is also applied to the wobbulator voice coil. This current allows the operator to vary the mechanical resting place of the diaphragm. Hence it serves to provide a fine control of the center frequency around which the oscillator sweeps.

A separate coarse center-frequency control is provided by

Fig. 4. The wobbulator assembly is a loud-speaker-like arrangement in which a set of capacitor plates are attached to diaphragm. When a 60-Hz low current is applied to voice coil, diaphragm vibrates at this rate and, in turn, moves plates.



an adjustable tuning slug placed in the main tank coil. Inductive tuning may be accomplished with a wobbulator device by substituting a brass or iron tuning slug in place of the capacitor plates on the wobbulator diaphragm. This assembly is then positioned so that the tuning slug may travel through the center of the oscillator tank coil and thus control the oscillator frequency in a manner similar to that of the capacitor previously described.

Electronic Sweep Generator

The all-electronic sweep generator may take the form of a modulated microwave tube, a variable-permeability device, or a voltage-controlled capacitor. While modulated microwave tubes find application at microwave frequencies, some manufacturers have used these tubes in conjunction with a fixed oscillator to provide a heterodyned output in the v.h.f. or u.h.f. bands. Variable-permeability devices employing a saturable reactor generally provide coverage of the 1- to 250-MHz band. Voltage-controlled capacitors are used in all bands, audio through microwave, and permit excursions greater than other electronic sweep methods.

Microwave Sweep. In the microwave region, where great frequency coverage and wide bandwidths are desirable, most manufacturers offer rather large equipment employing a grid-modulated backward-wave oscillator tube. By modulating this tube with a sweep-drive voltage, bandwidths of 200 to 400 MHz are easily achieved.

Some microwave sweeps have also been made by modulating the repeller of a klystron or modulating a tuned magnetron with the sweep-drive voltage.

Saturable-Reactor Sweep. Variable-permeability or saturable-reactor type sweep generators find wide use particularly because of the frequency bands covered and relative simplicity resulting in lower price. Saturable reactors, while chiefly used in the less expensive service-shop instruments, are also employed in more elaborate laboratory equipment because they are easily operated at the slow speeds that are necessary in order to drive mechanical recording instruments.

Fig. 6 shows a simple circuit diagram of a saturable-reactor sweep, and Fig. 7 pictures the actual construction and placement of such a device in a sweep generator.

Referring to both figures, it can be seen that the reactor is made up of the oscillator tank coil enclosed in a ferrite iron cup-shaped housing or core. This cup core is physically placed between the poles of a stack of U-shaped laminations. These laminations appear much the same as those used in transformer construction. Around one leg of the laminations is another coil which forms the plate load for the power-amplifier tube (V2).

To understand the operation of this circuit, let us suppose the oscillator circuit (V1) operates at 50 MHz when

Fig. 5. A 100-MHz oscillator with wobbulator frequency control.

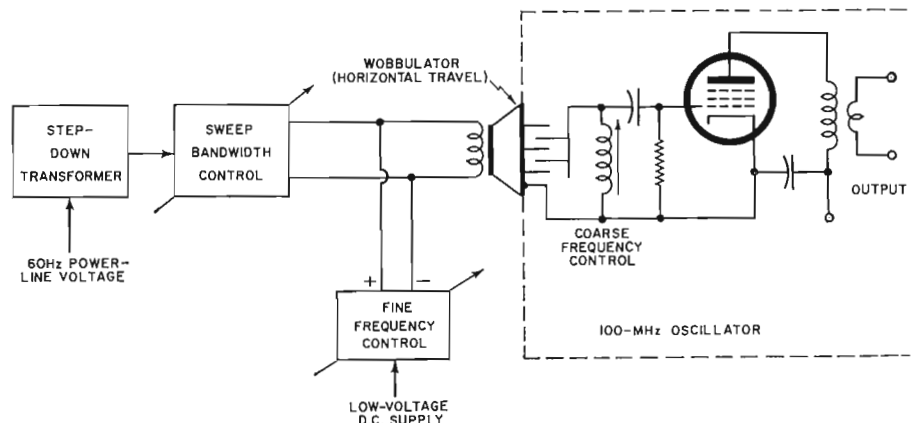

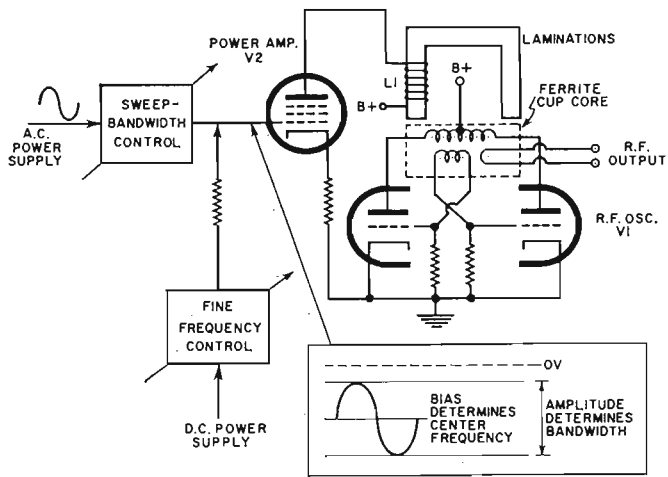

Fig. 6. A saturable-reactor type of sweep frequency generator.

no external modulation is applied and that some nominal amount of plate current is flowing through the plate load coil ($L1$). Now, if the d.c. bias on the power-amplifier grid is decreased, allowing the grid to become less negative, more plate current will flow through the plate coil ($L1$), thereby raising the magnetic flux induced in the laminations and hence across the cup core. The core, being made of a ferrite material, will be driven closer to its saturation point and the inductance of the oscillator tank coil will be reduced. Therefore, as the flux field increases, output frequency increases to a maximum determined by circuit capacitance and inductance. On the other hand, when grid bias is increased, plate current is reduced below the

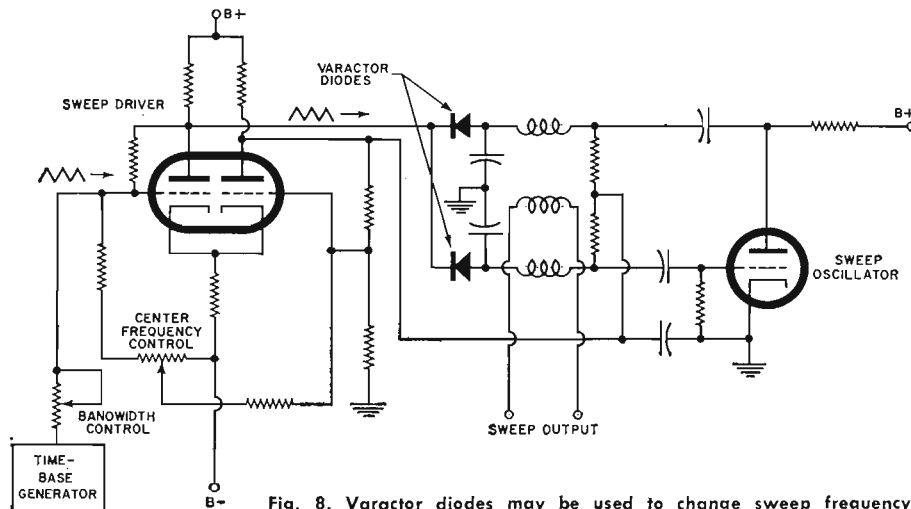

Fig. 8. Varactor diodes may be used to change sweep frequency.

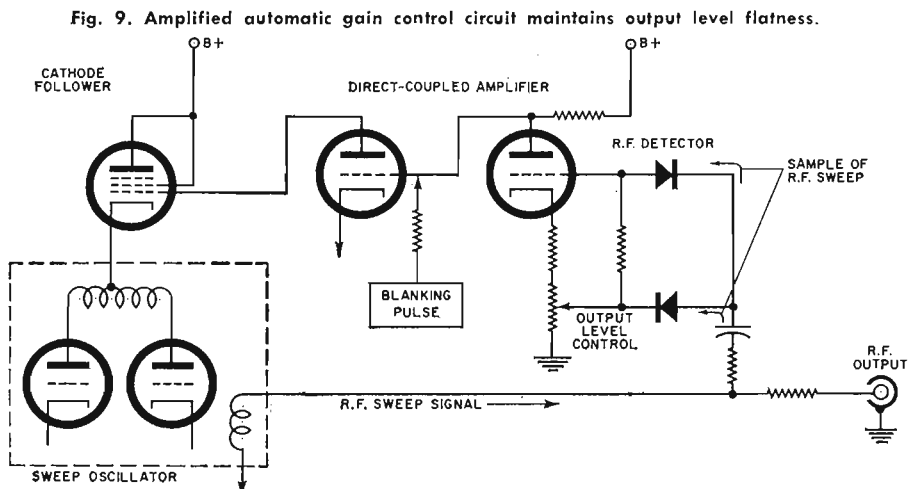

Fig. 9. Amplified automatic gain control circuit maintains output level flatness.

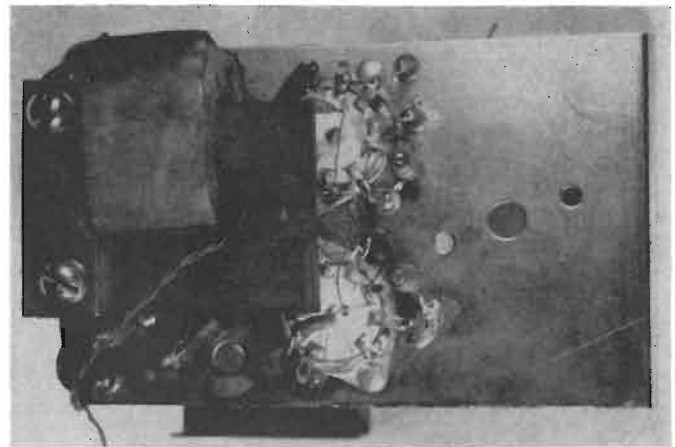

Fig. 7. Sweep-oscillator section of saturable-reactor sweep generator showing cup-core coil (with leads) in laminations.

nominal value, thus reducing the flux field which in turn drives the output frequency below 50 MHz.

By applying a modulating a.c. signal to the power amplifier, the r.f. oscillator will sweep through a frequency band determined by the amplitude of the modulating signal—high-amplitude sweep drive results in a maximum sweep excursion or maximum bandwidth. Saturable-reactor sweep generators are capable of approximately two octaves of bandwidth with relatively good frequency linearity.

Center-frequency control is accomplished by varying the d.c. bias on the power-amplifier grid, which will change the nominal plate current around which the modulating current will swing. Coarse frequency control may be obtained by shunting the oscillator plate coil with fixed or variable capacitors.

Although saturable-reactor sweep equipment suffers from the effects of drift and residual FM, wide sweep bandwidth, relatively good frequency linearity, and the ability to be driven at slow speeds make this type of equipment popular in many service-shop and laboratory applications.

Varactor Sweep. The voltage-controlled capacitor or varactor-type sweep generator relies on a reverse-biased semiconductor diode which exhibits a capacitance change in accordance with applied voltage. Varactor sweep generators can be used in any frequency band, audio through microwave, resulting in a distinct advantage over other sweep methods.

Sweep action is established by placing the varactor across the tank circuit of an oscillator as in Fig. 8. A change in the varactor bias voltage will result in a capacitance change and thus a frequency shift. Modulating the varactor with a 60-Hz a.c. signal results in sweep action with the sweep bandwidth controlled by varying the amplitude of the 60-Hz voltage within the limits of the varactor. Center-frequency control is achieved by varying the tank-circuit inductance or capacitance.

This type of sweep equipment offers several advantages over other electronic or mechanical sweep methods since the effects of drift, hysteresis, and limited frequency range are non-existent. These advantages make varactor

sweep equipment well suited for narrow-band, high sweep rate, and all-band operation.

Sweep Drivers

Next in importance when considering sweep-generator operation is the sweep driver. The sweep driver is that section of the generator which provides the sweeping oscillator control voltage, whether it be 60 Hz, variable speed, or manually controlled.

Most often used is the 60-Hz speed found as a standard feature in inexpensive service-shop instruments. Sixty-hertz sweep speed is popular because it is easily obtained from the power line and because this speed allows accurate measurements for all but a few applications dealing with sharp amplitude excursions where a 60-Hz sweep speed will not allow the scope and detector to follow the fast response changes.

Measurements of high-*Q* trap circuits and crystal filters frequently require sweep speeds well below 60 Hz as do measurements of audio-frequency devices. Sweep generators offering a variable sweep speed often allow the sweep rate to be reduced to one sweep every two minutes, permitting the measurement of steep amplitude excursions and the use of mechanical recording equipment.

Manual control of the sweep is useful in the laboratory where investigation of a discrete part of the sweep trace is desired. When used with a frequency meter, the manual control may be employed to spot or mark desired frequencies of interest along the response curve, such as the 3-dB down points.

Less expensive service-shop equipment generally provides only sine-wave sweep drive, resulting in equal trace and retrace times. However, laboratory equipment is available which allows selection of pyramid or saw-tooth modes, thus providing choice of various trace-to-retrace ratios for use with a mechanical recorder.

Important Parameters

After considering the sweep oscillator and drive modes available, thought should next be given to the following parameters: output power, sweep flatness, output impedance, and attenuation facility.

Output Power. The output power requirements of a sweep generator are determined by the intended application. Generators to be used for checking varactor frequency multipliers, such as those employed in microwave service, must be operated at specified power levels if proper results are to be expected. Generators used to measure extremely lossy circuits must provide sufficient output power to cover all intended uses. Consideration should also be given to wideband amplification and attenuation devices available for v.h.f. applications.

Flatness. Accurate measurements and ease of operation require the sweep output to be as flat as possible over the entire sweep bandwidth. Flatness is usually controlled by an a.g.c. circuit as shown in Fig. 9. A sample of the output sweep voltage is detected and the resultant d.c. voltage amplified by a direct-coupled amplifier having a cathode-follower output. The amplifier output controls the sweeping oscillator plate voltage and thus its output level. In this way, drop in output voltage is automatically compensated for by increased oscillator output.

Depending upon the gain of the

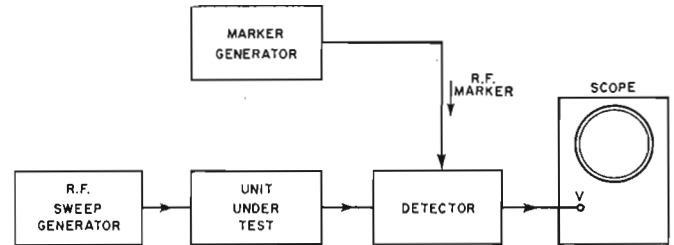

Fig. 10. Simple marker-injection system is illustrated here.

a.g.c. amplifier and the flatness of the sweep oscillator, extremely flat outputs may be obtained. Variation of ± 1 dB over narrow bandwidths may be expected using less expensive equipment, while ± 0.75 dB flatness over 200 to 400 MHz is available on more costly industrial and laboratory equipment.

When comparing flatness specifications, it is important to note over what band and at what power level the sweep flatness is being specified. For instance, the output level of some equipment is adjusted by varying the sweep oscillator plate voltage and/or by a variable attenuator, either of which may cause the flatness to deteriorate when the output level is changed. It is also important to note that flatness is contingent on the generator output impedance being matched to that of the test circuit.

Output Impedance. Test-equipment manufacturers generally offer as standard a 600-ohm output impedance at audio frequencies and 50 ohms at r.f. While these impedances cover most applications, some segments of the industry have standardized on other impedances; for example, 75- and 300-ohm impedances are used by TV manufacturers. Thus, many instrument manufacturers serving this market offer equipment with an optional 75-ohm output which can easily be converted to 300 ohms. However, if a power loss can be tolerated, the standard 50-ohm impedance may be matched to test circuits of different impedance by a properly designed resistive *L* pad or a tapered line.

Attenuation. Attenuation facilities built into some sweep equipment offer several advantages. First, this arrangement allows the convenience of adjusting the output level in calibrated steps, thereby offering a means of measuring the gain or loss of the item under test. Secondly, built-in attenuators allow control of sweep output power without

Fig. 11. Measurement setup employed to determine amount of r.f. gain or loss.

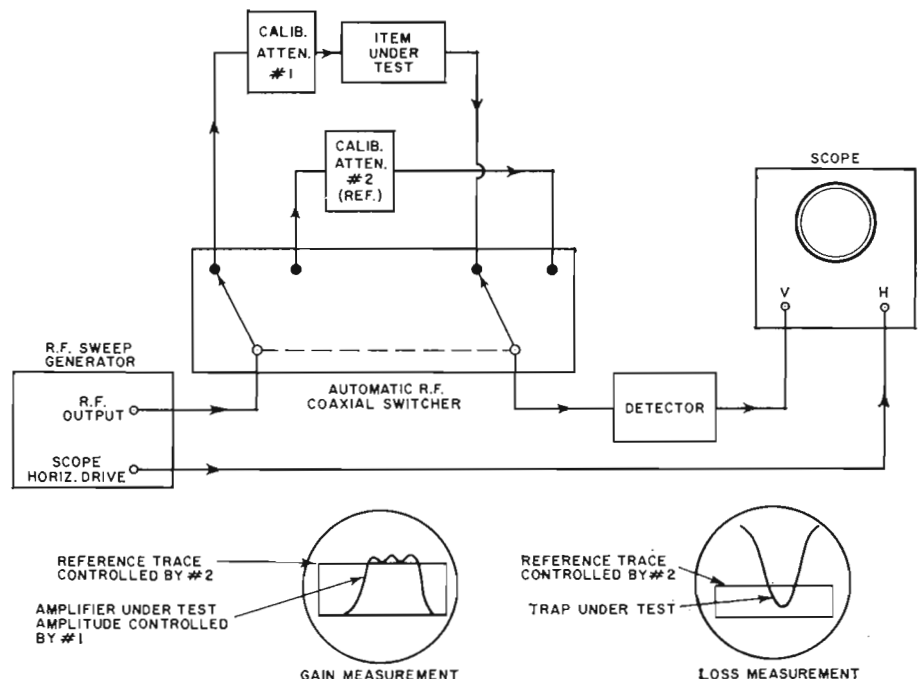

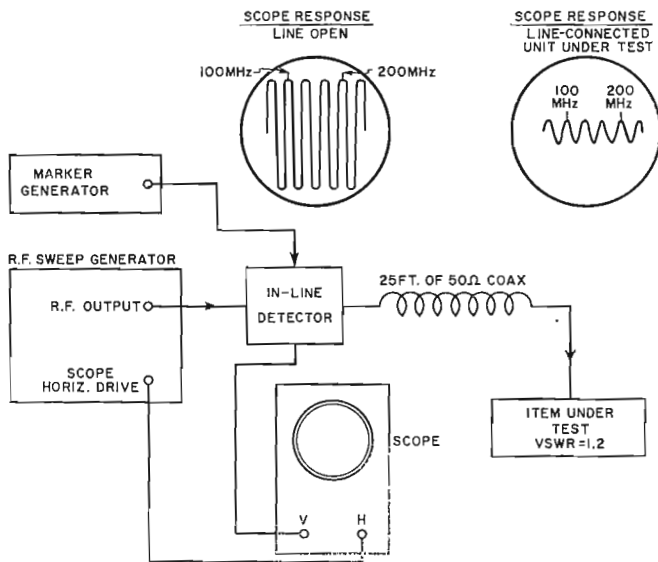

Fig. 12. Test setup used to measure the r.f. impedance match.

the expense of additional equipment and offer isolation between the sweep output and test circuit. Isolation is desirable, particularly at high r.f. frequencies, since external circuit impedance mismatch may cause deterioration of sweep flatness.

Blanking. Most sweep equipment allows the operator to blank either the forward or return sweep excursion. This is accomplished by reducing the generator output to zero during sweep trace or return, thus allowing a zero output reference trace to be established on the oscilloscope screen. Amplitude measurements are thereby made far more meaningful as well as more convenient.

Marker Injection

Several methods are commonly used to provide a frequency reference or marker on the sweep-generator output response. Frequency markers may be obtained by passing the sweep signal through a high-*Q* crystal filter, by inserting the output from a variable frequency generator into the sweep output or the detector, or by mixing a portion of the sweep-generator output with that from a variable frequency source. Absorption-type markers are generally used at microwave frequencies. These markers are produced by a calibrated, tunable trap or wavemeter, which produces a suck-out in the sweep response at the desired frequency.

Relatively simple marker injection, useful for most applications, is shown in Fig. 10. Note that the marker signal is not passed through the test circuit but rather is post-inserted at the detector. Since strong marker signals may overload or otherwise distort the operation of the test unit, post-injection is desirable in all but a few situations.

Better control of marker amplitude and shape is achieved by extracting a sample of the sweep output, heterodyning this with a signal from a variable or crystal-controlled oscillator, and feeding the resultant beat signal to the oscilloscope. Control of marker gain and shape is particularly useful when the sweep is changed from wide to extremely narrow bandwidths. Wide sweep widths require greater marker width and height, while reduced marker size and width are necessary at narrow sweep bandwidths.

Pulse-shaped markers formed by sweeping a crystal filter or tuned circuit can be used to modulate the sweep output or can be injected at the vertical input of the oscilloscope. Pulse

markers offer the same control of amplitude and shape obtainable with the previous system.

Applications

Over the years, sweep techniques have been best known for use in the alignment of television receiver i.f. circuits and FM discriminators. However, recent expansion in the area of microwaves, crystal filters, and wide-band TV distribution has demanded more sophisticated and versatile equipment. Features such as slide-rule tuning, amplitude modulation for recovery of weak signals, built-in automatic r.f. switches, and manual sweep triggering are but a few of the conveniences serving to broaden the usefulness of modern sweep systems.

A typical radio-frequency sweep measurement setup is shown in Fig. 11. Aside from the advantages of sweep techniques over point-to-point methods, this setup provides both simultaneous and accurate measurements of gain, loss, and tilt by employing commercially available coaxial attenuators and automatic r.f. switches.

Fig. 12 demonstrates a relatively simple way of making wide-band impedance-match measurements. In this application, the sweep generator is used to establish a ripple pattern on the oscilloscope screen. This ripple pattern results when a wide-band sweep generator is coupled to a section of coaxial cable or open-wire line which is electrically open (unterminated). The ripple, which looks like simple audio sine waves, is the result of the reflections of energy back and forth along the line. All the r.f. has been removed by the detector, so the pattern represents the standing waves on the line. The ratio of ripple amplitude produced when the line is open to the ripple amplitude when the line is connected to the item under test establishes a direct indication of impedance match. This ratio may easily be related in terms of v.s.w.r. If the load were perfectly matched ($v.s.w.r. = 1$), then the ripple amplitude would drop to zero and the pattern would be a straight line.

The same time-saving sweep techniques so useful for broadband response measurements also serve the needs of the designer who is investigating oscillator circuitry. In this function, a sample signal from the oscillator being tested is applied to the marker input of the sweep system. Proper setting of the sweep-generator bandwidth and center frequency provides a visual display of the fundamental, harmonic, and any spurious output frequencies. With such a sweep setup the designer can easily juggle components to achieve the desired conditions in regard to frequency stability, harmonic output, relative amplitude, and spurious emission.

Manufacturers of sweep generators are constantly demonstrating new techniques, and through the development of sweep accessories such as r.f. switches, r.f. impedance bridges, and marker systems, many previously laborious and time-consuming measurements can now be made with speed and accuracy. Indications are that continued research will further expand the versatility, speed, and accuracy of sweep frequency systems.

When used in conjunction with an oscilloscope, sweep frequency generators greatly simplify the making of frequency response measurements, particularly on broadband equipment.

Ancillary equipment for creating frequency markers on the oscilloscope trace greatly aid the sweep generator by providing a reference point from which the pertinent frequency response points can be determined.

Some service-type sweep generators have this provision built in, while others use an external source of accurately known frequencies as a reference. ▲

Fig. 13. Typical portable sweep generator.



EW Lab Tested

(Continued from page 16)

The Model 7T has eight inputs, selectable by a front-panel rotary switch, plus recording and playback connections for a tape recorder, controlled by a separate "Tape Function" lever switch. A unique feature is the pair of front-panel jacks for recording and playback connections to a second external tape recorder. The preamp has low-level equalized inputs for a tape head and two magnetic cartridges,

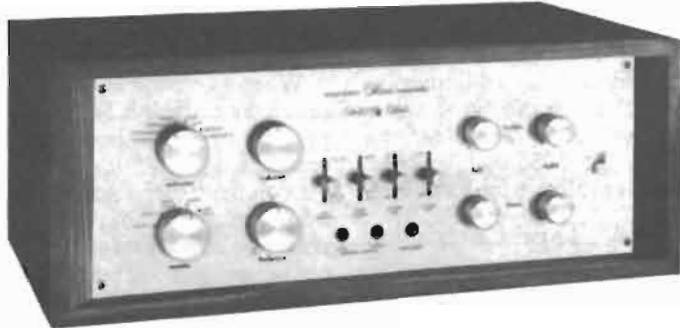

plus an unequalized microphone input. There are four high-level inputs.

On the rear of the chassis, in addition to the various input jacks, there are two pairs of parallel-connected output jacks for driving the power amplifiers and a pair of parallel-connected center-channel (A + B) output jacks with their own level control. The main outputs will drive loads as low as 600 ohms without distortion. There are five switched a.c. outlets and one unswitched outlet. A pair of screwdriver-adjusted controls permits the NAB tape-playback equalization to be trimmed to compensate for head wear in the recorder. As a final touch, there is a pair of "Scope Test" output jacks for checking phase shift or stereo separation with an oscilloscope.

The four tone controls (separate bass and treble controls for each channel) use step switches instead of the usual continuously variable potentiometers. The treble controls have five positions of cut and five of boost while the bass controls have four positions of cut and six of boost.

In the center flat position of each tone control, all tone-control circuitry is bypassed. Each step on the treble controls provides a 2.5-dB boost or cut

in high-frequency response and each step of the bass controls corresponds to a 3-dB change in low-frequency response.

The "Phono Equalizer" has the old 78 rpm and the old Columbia LP characteristics in addition to RIAA equalization. A "Low-Freq. Filter" is used with cut-off frequencies of 50 and 100 Hz, while the "High-Freq. Filter" has cut-off frequencies of 5000 and 9000 Hz. The filters have a 12 dB/octave roll-off.

We measured the frequency response of the Model 7T at ± 0.1 dB

from 20 to 20,000 Hz. The RIAA phono equalization was within 0.5 dB of the ideal characteristic from 30 to 15,000 Hz and the NAB tape equalization was accurate to within 0.7 dB. The filters had near-ideal shapes, with no effect on mid-range response. Their cut-off frequencies were almost exactly as specified. (See figure.)

At 10 volts output (far more than could be used to drive any power amplifier), the harmonic distortion was under 0.15% between 20 and 20,000 Hz. At lower signal levels, it was too low to measure. The IM distortion was less than the residual distortion of our instruments up to 10 volts output. (Both the harmonic and IM distortion measuring equipment used in our tests have residual distortions of about 0.06%.)

At maximum gain, a signal of 60 millivolts at a high-level input, or 0.6 mV at the phono input, was sufficient to drive the Model 7T to a 1-volt output, which is enough to drive almost any power amplifier to full output. There was no measurable (or audible) crosstalk between inputs. The noise level (a smooth hiss audible only at or near maximum gain) was 84 dB below 1-volt output on high-level inputs

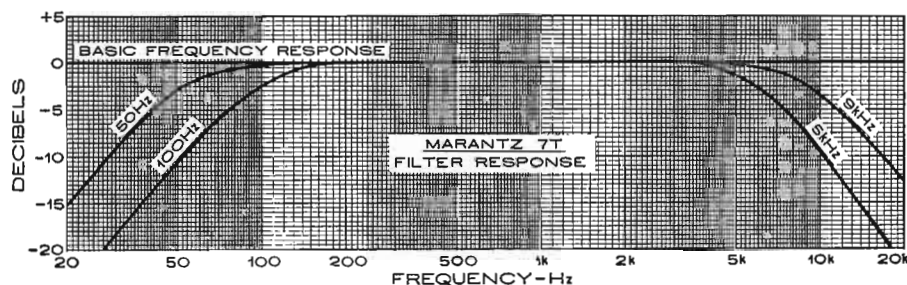

for the critical ear

SHURE

Stereo Dynamic[®]

HIGH FIDELITY PHONO CARTRIDGES

ALL THE MOST WANTED FEATURES



M55E

15° TRACKING, ELLIPTICAL STYLUS

Professional performance at a modest price. Compares favorably to the incomparable Shure V-15, except that it is produced under standard Shure quality control and manufacturing techniques. Remarkable freedom from IM, Harmonic and tracing distortion. Will definitely and audibly improve the sound of monaural as well as stereo records. ¾ to 1½ tracking. \$35.50. M44E cartridge tracks 1½ to 4 grams with elliptical stylus. \$34.50.

Write for literature:

SHURE BROTHERS, INC.

222 HARTREY AVE., EVANSTON, ILLINOIS

CIRCLE NO. 88 ON READER SERVICE CARD

Every No-Noise Aerosol Product

Guaranteed

Non-Flammable

Non-Toxic and

Won't Affect Plastics

"NO NOISE"

Insist On This Trusted
NAME BRAND
Avoid Risky "Private Labels"

"No Noise" PRODUCTS ARE
PERFECT FOR COLOR TV

- Volume Control & Contact Restorer
- Tuner-Tonic with Perma-Film
- EC-44 For Electrical Contacts
- Tape-Reco Head Cleaner
- Frigid-Air Circuit Cooler

FREE 5" plastic extender push-button assembly for pin-point application with all No-Noise products.

ELECTRONIC CHEMICAL CORP.

813 Communipaw Avenue, Jersey City 4, N. J.

CIRCLE NO. 118 ON READER SERVICE CARD

SPECIAL

FROM HIFI/STEREO REVIEW

DELUXE DUST-PROOF RECORD AND TAPE CASES *Plus* FREE CATALOGING FORMS



These decorative, yet sturdily constructed cases are just what you've been looking for

to keep your records and tapes from getting tossed about and damaged, disappearing when you want them most and just generally getting the "worst of it" from constant handling. They're ideal too for those valuable old "78's" that always seem to get thrown about with no place to go.

Constructed of reinforced fiberboard and covered in rich leatherette in your choice of eight decorator colors, the HIFI/STEREO REVIEW Record and Tape Cases lend themselves handsomely to the decor of any room, whether it be your library, study, den, music room or pine-paneled garage. The leatherette back (in your color choice) is gold tooled in an exclusive design available only on HIFI/STEREO REVIEW Record and Tape Cases. The sides are in standard black leatherette to keep them looking new after constant use.

Extra With each Record and Tape Case you order you will receive, free of charge, a specially designed record and tape cataloging form with pressure-sensitive backing for affixing to the side of each case. It enables you to list the record names and artists and will prove an invaluable aid in helping you locate your albums. The catalog form can be removed from the side of the case at any time without damaging the leatherette.



Record Cases are available in three sizes: for 7", 10" and 12" records. Each case, with a center divider that separates your records for easy accessibility, holds an average of 20 records in their original jackets. The Recording Tape Case holds 6 tapes in their original boxes.

● The Tape Cases and the 7" Record Cases (with catalog forms) are only \$3.25 each; 3 for \$9; 6 for \$17.

● The 10" and 12" Record Cases (with catalog forms) are \$3.50 each; 3 for \$10; 6 for \$19.

Add an additional 75¢ per order (regardless of number of cases ordered) for shipping and handling.

Ziff-Davis Publishing Company, Dept. SD
One Park Avenue, New York, N. Y. 10016

My remittance in the amount of \$_____ is enclosed for the Cases indicated below.

Quantity _____ Tape Case at \$3.25 each; 3 for \$9; 6 for \$17.
 _____ 7" Record Case at \$3.25 each; 3 for \$9; 6 for \$17.
 _____ 10" Record Case at \$3.50 each; 3 for \$10; 6 for \$19.
 _____ 12" Record Case at \$3.50 each; 3 for \$10; 6 for \$19.

Add 75¢ PER ORDER for SHIPPING and HANDLING
 Check color choice for back of case (sides in black only):

Midnight Blue Red Saddle Tan
 Pine Green Orange Yellow
 Grey Spice Brown

Name _____ Address _____ EW-116

City _____ State _____ Zip Code _____

PAYMENT MUST BE ENCLOSED WITH ORDER

and 72 dB below 1 volt on phono. No hum was detectable.

In use, there were absolutely no clicks or other switching transients when operating the controls. All controls had a silky smoothness and positive "feel" which must be experienced to be appreciated. The tone-control curves were excellent for loudness compensation and even at their extremes did not produce an unnatural effect. The filters were highly effective in removing noise with minimum effect on the program material.

Used with a good power amplifier, the preamp provides almost limitless flexibility—more than most of us could use—combined with almost ideal frequency response and linearity characteristics. It could well be a lifetime investment and the manufacturer offers a three-year warranty. The Marantz Model 7T sells for \$325.00. An oiled walnut cabinet is available for \$24.00. ▲

Tape Cartridges

(Continued from page 32)

board lighter. Some are also battery powered.

Philips, G-E, Mercury Records, Sony, Panasonic, Magnavox, Concord, and Revere-Wollensak are some of the manufacturers of these units. Mercury has recently announced the release of 49 stereo cassettes at \$5.95 each, including 26 albums from their own catalogue, 8 from Philips, and the rest from smaller pop-field companies. Philips has an extensive library of European recordings in cassettes.

(Editor's Note: According to the manufacturer, more than a million units of the cassette instrument have been sold throughout the world since its introduction in 1964. They predict that by the end of this year more than 500,000 auto, home, and portable units of this type will have been sold in this country. The company also announced that over 40 manufacturers and marketers of tape recorder equipment throughout the world have adopted the Philips cassette system.)

All of the cartridge deck manufacturers offer speakers with their players, either as a separate purchase or in combination with the player. Prices range from about \$15 per set to \$40 or more for home speakers.

Recording & Sound Quality

For those who want to make their own recordings, several record/playback units are now available in either 4- or 8-track single-reel cartridges or in two-reel cassettes. Some have been built in combination with disc players or conventional reel-to-reel tape players, and all of them record directly into the cartridge. All have inputs for microphones or for other playback equip-

ment which the owner may have. Prices range from around \$90 for table models to \$400 for consoles.

Still missing from the single-reel cartridge picture is the fast-forward and reverse feature. You cannot spot a particular selection on a given band of music unless it occurs at the beginning of the tape. However, since each band contains only about 15 to 20 minutes of music, the wait cannot be too long. Meanwhile, if the listener knows the content of his cartridge well enough, he can switch channels to spot the music he wants. (In the case of the cassette system, fast-forward and fast-reverse speeds are provided as well as calibrated cassettes for spotting a particular selection on the tape.—Editor.)

When considering the quality of sound in cartridge equipment, it is important to remember that most of it was first designed for the car where its stereo effect surpasses anything coming from the car radio. Also, the cartridge was originally designed for the mass consumer market and not the sophisticated audiophile. Over the past year, cartridge technology has improved to the point where many cartridge players have a frequency response from 50 to 14,000 Hz. Recording standards have not yet reached this potential with any consistency and most recordings average out at 7500 Hz top. However, improved magnetic heads are rapidly changing this picture; and tape manufacturers are working on finer oxide coatings which should make it possible for cartridge recordings to match the quality of 7½-ips reel-to-reel recordings. Meanwhile, a few record companies are turning out a consistent quality of about 11,000 Hz top.

In summary, there are many advantages of cartridge over disc or reel-to-reel tape. These include less storage space and a self-contained package with no threading or rewinding. And safety—you can trust a child to play a cartridge without damage to your player or recording.

The choice of a system is up to the consumer's taste and pocketbook: lower-priced 4-track units with a larger existing pop library; more expensive 8-track players with a smaller current selection from the major record companies; a compatible unit which will allow the user to play either. Or, there is the Philips cassette system, a mighty midget for which a large European library and some American labels are already available. And if these choices are not enough, there is still the RCA reel-to-reel cartridge system, which has been on the market for several years. And now there is a newly announced continuous loop cartridge system from MGM, using ½" tape. All in all, the magnetic tape cartridge is here to stay, in one form or another. ▲

Looking for Hi-Fi equipment, but in the dark about which to buy? Well you can always...

1



Ask your Uncle Fred. He used to fix your toaster.....

2



Inquire from store to store to store to store.....

3



Choose the one that looks nicest. And cross your fingers.....

or you can get a copy of the **1967 STEREO/HI-FI DIRECTORY**



and forget about the first 3!

If you think buying hi-fi equipment has to be a game of "musical chairs" . . . **chance not choice** . . . we've got news for you! Now there's a quick, easy, foolproof way to plan your next equipment purchase: with the all-new 1967 STEREO/HI-FI DIRECTORY.

It's a giant, 180 page buyer's guide to virtually every new audio component on the market—

- amplifiers • changers and turntables • cartridges—arms—accessories • receivers • tuners • tape machines • speakers/cabinets • hi-fi systems • miscellaneous accessories

PLUS—special directories for **home TV tape recorders** and **tape cartridge machines for cars and boats!**

Every technical specification, measurement, special feature, optional accessory, price and model number

of all the latest products is at your fingertips. Including detailed photos. To help you compare similar items—feature for feature, dollar for dollar—and decide which is best for you. **Before** you buy!

Forget the guesswork, costly mistakes and "after-you-get-it-home" disappointments. With the 1967 STEREO/HI-FI DIRECTORY as your authoritative guide, you buy with confidence—and **know** you're getting the greatest value for your money on every piece of equipment you select.

The price for this valuable "encyclopedia" of hi-fi information? Just \$1.25. A very small investment when you think of the time, trouble and money it's guaranteed to save you. So don't delay. Use the coupon below and order your copy of the 1967 STEREO/HI-FI DIRECTORY today!



GET THE HANDSOME LEATHER-FLEX-BOUND EDITION for just \$3 POSTPAID!

The 1967 STEREO/HI-FI DIRECTORY is also available in a splendid deluxe edition. Rugged Leatherflex cover provides lasting protection yet is softly textured and gold-embossed for the look of elegance. A collector's item—a superb addition to your permanent hi-fi reference library. And it's yours, for just \$3 postpaid, when you check the appropriate box on the order form.

ZIFF-DAVIS SERVICE DIVISION • DEPT. SD • 589 Broadway • New York, N. Y. 10012
YES! Send me the new 1967 STEREO/HI-FI DIRECTORY.

- \$1.25 enclosed, plus 15c for shipping and handling. Send me the regular edition. (\$1.75 for orders outside the U.S.A.)
- \$3.00 enclosed. Send me the Deluxe Leatherflex-bound edition, postpaid. (\$3.75 for orders outside the U.S.A.) Allow three additional weeks for delivery.

name _____ please print _____ EW-116
address _____
city _____
state _____ zip code _____

PAYMENT MUST BE ENCLOSED WITH ORDER

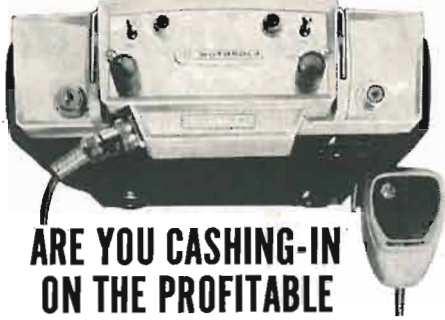

ARE YOU CASHING-IN ON THE PROFITABLE 2-WAY RADIO SERVICE BUSINESS?

- ★ Motorola will train you for this rewarding, elite profession
- ★ Send for our FREE EVALUATION EXAM. Prove to yourself that you are ready to learn FM 2-way radio servicing.

Opportunities in 2-way radio servicing are virtually unlimited. Just one of the hundreds of successful Motorola Service Stations writes, "we would be pleased to interview any graduate of your school that has received some training in 2-way radio maintenance. We are an established firm, 10 years old, with a promise of expansion governed by our ability to obtain competent technicians." Get all the facts today. There is no obligation and no salesman will call.

MOTOROLA TRAINING INSTITUTE

4545 West Augusta Blvd. • Chicago 51, Illinois • Dept. AEF646

- Send me FREE entrance exam.
- Send full details on Home Study Course on FM 2-way Radio Servicing
- Send me details on how you can help me prepare for an FCC License.

Name _____ Occupation _____
Address _____
City _____ Zone _____ State _____

CIRCLE NO. 101 ON READER SERVICE CARD

Sonalert®

New high-reliability solid-state tone signal

Produces distinctive 2800 or 4500 cps tone, draws only 3 to 14 milliamps.

No RF noise—no arcing contacts. Explosion-proof.

High reliability—solid-state oscillator drives piezoelectric sound transducer.

High output—68 to 80 db sound level.



Standard models available for operation on 6 to 28 volts DC, 6 to 28 volts AC, 110 volts AC. Can be supplied with pulsed output, 3 to 5 pulses per second. For data, typical circuitry for over-voltage, under-voltage, overheat, security, and many other signalling applications, write Mallory Distributor Products Company, a division of P. R. Mallory & Co. Inc., P.O. Box 1558, Indianapolis, Indiana 46206.



CIRCLE NO. 103 ON READER SERVICE CARD

with the model. In the 19-inch portable, a single-ended output stage is used. This transistor, a 71N1, is a low-current, high-voltage type with a collector load impedance of approximately 3000 ohms. This is quite similar to a typical audio output tube.

One of the novel features of this receiver is the light-dependent resistor (LDR) circuit that provides automatic brightness adjustment for varying room lighting conditions. The light-dependent resistor, R1 in Fig. 2, is mounted near the front of the TV set but is electrically connected across the emitter resistor of video output amplifier Q1. This transistor receives the video signal on its base and receives a fixed forward bias through R2 and R3. Emitter resistor R4 is shunted by the LDR. Note that the collector of Q1 is d.c.-connected to the cathode of the picture tube as well as to the brightness control, which is a d.c. adjustment. When room lighting increases, LDR resistance becomes smaller, which means that there is less total emitter resistance in Q1. With less emitter resistance, Q1 has more gain and thereby produces a larger amplitude video signal. At the same time, the average d.c. collector voltage is reduced because a larger current is being drawn through R5. Because of the d.c. connection of the Q1 collector, this increased voltage drop lowers the positive voltage on the cathode of the picture tube, increasing brightness as well as contrast.

If ambient room lighting decreases, LDR resistance increases. This reduces the gain in Q1 as well as the current drawn by R5 and thereby provides less contrast and less brightness on the picture-tube screen. A 33-ohm resistor is connected in series with the LDR to limit the variation of its resistance to avoid over-correction. As shown in Fig. 2, the screen grid of the picture tube controls the beam current for a given level of ambient light, contrast, and brightness. In combination with the front-panel contrast and brightness adjustments, the secondary control (LDR adjustment R6) is used to set the operating range of the automatic brightness circuit.

The sync separator and the vertical oscillator output circuits are very much like those found in other transistor receivers. The vertical deflection coils are connected in parallel across an iron-core choke.

This TV receiver is the first model to use a conventional blocking oscillator transformer and circuit to generate horizontal sweep voltage. This circuit, shown in Fig. 3, uses a single transistor and two diodes to provide the a.f.c. as well as the saw-tooth generation function. The output of the sync separator is applied to a set of dual diodes for phase comparison with a feedback signal from the horizontal output transformer, just as in all TV receivers. The d.c. correction

Fig. 3. Horizontal oscillator frequency is controlled by variations in d.c. across D1 produced by either horizontal hold control or correction voltage from horizontal phase comparator.

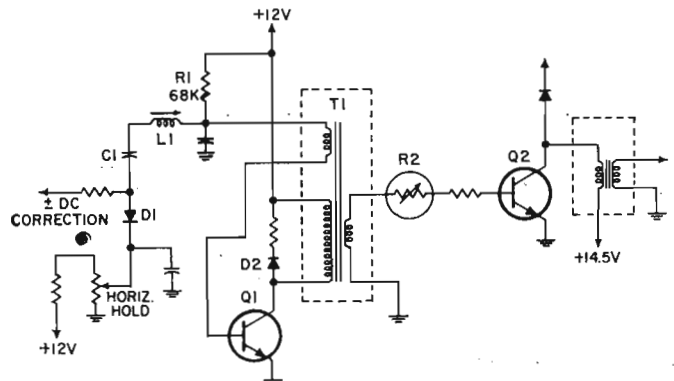

voltage developed there, however, is then applied directly across diode *D1*, which acts as a capacitor that is variable by the d.c. applied across it. Transistor *Q1* oscillates easily because of coupling between the collector and base through the two respective windings of *T1* and forward-biasing resistor *R1*.

The frequency of oscillation is controlled by a resonant network consisting of *L1*, *C1*, and diode *D1*. The horizontal-hold control sets the positive voltage which is placed on the cathode of *D1* and thereby controls the action of the d.c. correction voltage from the phase comparator. The resonant frequency of *L1*, *C1*, and *D1* is varied by changing the d.c. voltage across *D1*, either through a change in correction voltage from the phase comparator, or through a change in the positive voltage from the horizontal hold control. Across the collector winding of the blocking oscillator transformer, diode *D2* and a series resistor limit the high positive voltage spike which occurs when the transistor is cut off.

The third winding on transformer *T1* provides output pulses to *Q2* (the horizontal driver stage). Resistor *R2* is a temperature-sensitive resistor which is mounted near *Q1* and which compensates for temperature variation. As the temperature of *Q1* increases, *R2* will decrease in resistance, producing a heavy load across *T1* and causing a change in the inductance reflected back into *Q1*. With proper polarity connections, the inductance change is such as to correct for any frequency drift of the oscillator, and this stabilizes the collector current as well.

The horizontal output circuit of the *Magnavox* unit is very similar, at least in its principle of operation, to that described for previous transistor receivers. The output transistor drives the two horizontal deflection coils in parallel, as well as the primary of the flyback transformer. An autotransformer secondary is used to step up the voltage for the vacuum-tube rectifier which produces +18 kV. The damper diode is connected directly across the output transistor, and a separate diode is used to rectify the boost voltage to provide +500 volts, which is then used for the focus element and the screen grid of the picture tube. ▲

NEW WWV STARTING DATE

THE National Bureau of Standards (U.S. Department of Commerce), recently announced that effective 0000 UT, December 1, 1966, all of the services presently provided on 2.5, 5, 10, 15, 20, and 25 MHz by the Bureau's broadcast station WWV located at Greenbelt, Maryland, will be continued by WWV now installed in its new location at Fort Collins, Colorado. ▲

Did you ever...

... lift a wire-lead component from a printed wiring board for testing?



... test or replace a capacitor or resistor on a crowded tube socket?

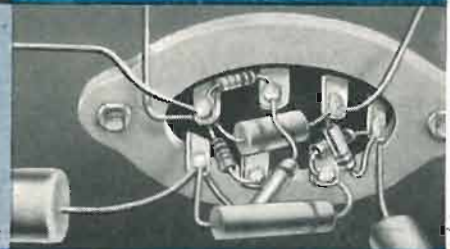

CUT YOUR TIME IN HALF with **KWIKETTE*** Soldering-Aids

...the revolutionary connectors that practically let you do "in-circuit" component testing!

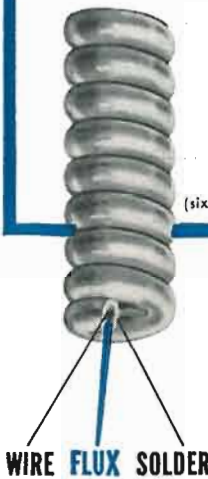

(six times actual size)

WIRE FLUX SOLDER

The KWIKETTE SOLDERING AID is not just another wire spring connector! It has a Copperweld wire inner core, an intermediate layer of flux, and an outer jacket of solder... **all you need is heat!**

KWIKETTES are now being packed with Sprague Atom® Capacitors at no extra cost to you! Whenever you need tubular electrolytics, insist on pre-packaged Sprague Atoms from your parts distributor and you'll automatically get your KWIKETTE component connectors... the biggest boon to the service technician since the soldering gun!

*trademark

FREE TRIAL PACKAGE!

10 free KWIKETTE Soldering Aids are yours for the asking! Simply send your postcard request to KWIKETTE Center, Sprague Products Co., 51 Marshall Street, North Adams, Mass. 01247. Don't forget to include the name of your Sprague Distributor.

SNIP LEAD...

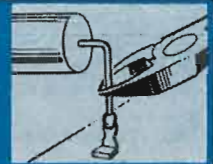

TEST...

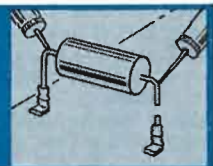

SLIP ON KWIKETTE...

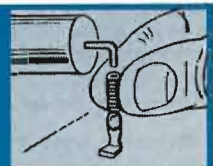

APPLY HEAT!

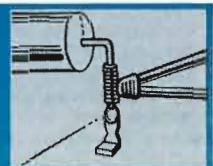

SPRAGUE®
THE MARK OF RELIABILITY

WORLD'S LARGEST MANUFACTURER OF CAPACITORS

85-6109

CIRCLE NO. 35 ON READER SERVICE CARD

NEW PRODUCTS & LITERATURE

Additional information on the items covered in this section is available from the manufacturers. Each item is identified by a code number. To obtain further details, fill in coupon on the Reader Service Card.

COMPONENTS • TOOLS • TEST EQUIPMENT • HI-FI • AUDIO • CB • HAM • COMMUNICATIONS

INFRARED PYROMETERS

Infrared radiation pyrometers which are capable of measuring the temperature of objects up to 25 feet away with an accuracy of ± 2 percent are now available. The new instruments are of the quantum detector type. They use semi-



conductors in a remote-mounted detector head to measure radiation. Electrical signals are produced and transmitted to an amplifier system where they are changed to usable form and displayed on a pyrometer.

If control action is desired, the Series 700 temperature controller may be integrally installed in the amplifier housing. "On-off", time-proportioning, or SCR proportioning control action is then available.

The initial model in the series, Model 860, uses a lead sulfide photon detector and reads temperatures in the 200° to 1050°F range at wavelengths from 2 to 2.6 microns with a response speed of 0.1 second for 95 percent in full scale. API

Circle No. 126 on Reader Service Card

600-WATT FULL-RANGE DIMMER

A new economically priced full-range, 600-watt dimmer control is now being marketed as the No. 6681. Listed by UL, the new device provides push-on, push-off control and is designed for easy installation.

The dimmer features Specification Grade construction, including printed circuits; a radio-TV interference filter; definite "on-off" positions; and components selected to resist vibration, shock, and temperature change.

The No. 6681 is rated at 600 watts, 120 volts a.c., incandescent only. A three-way version is also available. Leviton

Circle No. 1 on Reader Service Card

SELECTIVE NULL DETECTOR

A tunable null detector with a sensitivity of 1 microvolt for full-scale meter deflection, a frequency range of 15 to 100,000 Hz, and 5-10% bandwidth is now available as the 96016-A.

The instrument can be used as a sensitive detector in bridge balancing and as a low-noise preamplifier for increasing the sensitivity of instruments such as scopes and v.t.v.m.'s.

A linear or a logarithmic response can be ob-



tained from the output amplifier by operating a switch. This simplifies the search for a null point by widening the scale logarithmically. External filters can be used to extend the scope of the instrument.

Input impedance is either 50,000 ohms or 1 megohm depending on the gain control setting. Output impedance is about 300 ohms in series with 5 pF. Maximum output is about 1 volt r.m.s. The instrument operates from two 6-volt dry cells. ITT

Circle No. 127 on Reader Service Card

ELECTRONIC CONTROL KITS

Three "experimenter kits" which make possible the construction of 14 different electronic control circuits using silicon controlled rectifiers, thermistors, and photocells are now on the market.

Among the circuits which can be built are: speed controls for food mixers, power tools, model electric trains and autos; electronic timers and time-delay switches for photography; warning flashers; battery chargers for 6- and 12-volt batteries; light dimmers; light- and heat-activated controls for automatic lighting and heating; and overload and synchronous switches.

The basic kit, KD2105, includes one SCR, five silicon rectifiers, and two transistors. Two "add-on" kits, KD2110 and KD2106, can be used with the basic kit to permit construction of more exotic control devices. An 80-page manual, KM-70, gives step-by-step instructions for the construction of each control circuit. RCA Electronic Components and Devices

Circle No. 2 on Reader Service Card

MICRORESISTORS

Two new cermet element microresistors have been introduced as the Models 4205 and 4201.

The Model 4205 measures just 0.3" x 0.05" x 0.03" and has gold-plated nickel leads emerging from an epoxy-coated alumina substrate. The Model 4201 is a resistor chip without leads measuring just 0.1" x 0.05" x 0.03". Its sides are grooved and tinned with solder, allowing maximum connection versatility. It is especially suited to dense hybrid circuit packaging applications since it can be inserted between other micro-components.

Standard resistance tolerances of $\pm 1\%$, $\pm 2\%$, $\pm 5\%$, and $\pm 10\%$ are available. The resistances range is 10 to 200,000 ohms for the Model 4201 and 200,000 ohms to 1 megohm for the Model 4205. Power rating is 0.07 watt at 100°C. Bourns Trimplot

Circle No. 128 on Reader Service Card

LINEAR IC's FOR FM SETS

Two "economy-line" linear IC's for use in FM radio receivers and other commercial and industrial equipment applications have been introduced as the Types CA3005 and CA3014.

The CA3005 is a r.f. amplifier and is designed to be used in the first stage to handle r.f., mixer-oscillator, and i.f. driver functions while the wideband amplifier-discriminator type CA3014 performs the functions of i.f. amplifier, AM and noise limiter, FM detector, and audio pre-amplifier.

Each of the CA3014 chips is no larger than the letter "o" on a typewriter and can replace 39 discrete circuit components. The IC offers excellent performance between 100 kHz and 20 MHz.

The IC's are packaged in the TO-5 transistor-type case no larger than an aspirin tablet. Additional technical information on the CA3005 and

CA3014 is available on request. RCA Electronic Components and Devices

Circle No. 129 on Reader Service Card

INSTRUMENT MOTOR LINE

A new line of sub-fractional horsepower, synchronous and induction motors has been introduced as the 1020 series. The entire stator is insulated with an epoxy coating which is applied in powder form and is cured by heat to form a continuous film. By eliminating the conventional slot-cell and end-lamination insulators, the dielectric strength has been increased, reliability improved, and manufacturing costs reduced. The thin, epoxy film also allows additional copper

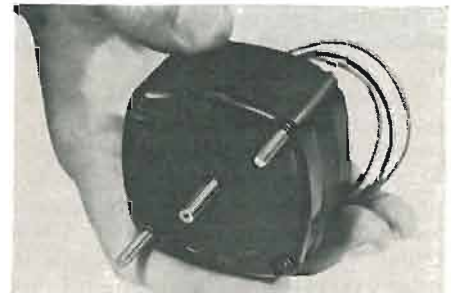

windings in the stator slots for increased efficiency. Heat dissipation and resistance to moisture are also improved.

The 1020 motors offer a smooth output speed at a high-rated running torque. The motors are as short as 1 $\frac{1}{32}$ " yet offer torques from 0.3 to 150 oz/in and speeds from 1 to 1800 rpm. Complete information on this new line is available on request. Amphenol Controls

Circle No. 130 on Reader Service Card

GARAGE-DOOR OPERATOR

A new electronic garage-door opener whose transmitter is completely portable and requires no installation has been introduced as the "Electro-Lift". The new unit is especially designed for single-car garages but may also be used on two-car garages with one-piece solid doors.

The openers will open, close, and securely lock the garage door automatically as well as control the garage light to provide safe and convenient "doorman" service from 100 feet away.

Of all-transistor design, the new units meet FCC rules and are certified for operation without a license. A catalogue sheet, LCG-680, describing the "Electro-Lift" in detail will be forwarded on request. Perma-Power

Circle No. 3 on Reader Service Card

INFINITE RESOLUTION TRIMMER

The new Series IRW trimmer measures 1.262" long x 0.323" high x 0.288" thick, offers infinite resolution, 0.01% stability, and 0.0005% settability.

Its different design concept consists primarily of a contact which slides along the entire length of the spiral winding instead of from turn to turn. This eliminates any danger of the contactor shorting turns together, as well as eliminating fluctuations in shorting of adjacent turns by the contactor as environmental conditions vary. For easy settability, elements are up to three feet long.

Applications are in fields where resistors must be preset to pinpoint accuracy and maintain a constant ratio with no change over longer periods

of time. These include such fields as navigational equipment, test equipment, machine tools, and production equipment. CTS

Circle No. 131 on Reader Service Card

NEW POWER RECTIFIERS

High-current rectifier types, numbering 238 items in all, have been added to a power rectifier line which consists of a broad selection in the 100, 150, and 160 ampere range and over a hundred types in the 240, 250, and 275 ampere series.

Power conversion equipment using these components supply thousands of kilowatts of d.c. power for motor drives, arc furnaces, electrochemical extraction and refining processes, and general-purpose power in mills and mines.

Detailed engineering specifications on this new line are available on request. IRC, Inc.

Circle No. 132 on Reader Service Card

TV REPLACEMENT RELAYS

A standard stock line of TV replacement relays is now available. Designed for specific television chassis, the line combines new and tested materials: nylon cams and glass-filled nylon bobbin and cover; acetal copolymer material is used in the integral molded platform bearing and armature hinge, greatly reducing friction and extending operating life.

The relays are available in either open, snap-on dust cover, or hermetically sealed construction. No changes are required in mounting, terminals, or ratings. Cornell-Dubilier

Circle No. 4 on Reader Service Card

REGULATED 500-WATT SUPPLIES

The development of a series of solid-state continuously variable regulated power supplies delivering 500 watts d.c. has been announced.

Three models with output ranges of 2 to 32 V, 2 to 55 V, and 2 to 125 V are designed for continuous heavy-duty production testing; design; electronic and electromechanical circuitry development in industry; laboratories and schools; as well as for aircraft, military, and commercial



uses where a regulated d.c. output is required.

Ripple is less than 1% at maximum rated current and load regulation is less than 1% for both line and load changes. All have solid-state circuitry with silicon rectifiers and SCR regulation. Fused input, circuit-breaker output protection is provided. Full details are included in Spec. Sheet PS-3 which will be forwarded on request. Electro Products

Circle No. 133 on Reader Service Card

MICROCIRCUIT SOLDERING IRON

An answer to the problem of hand soldering microcircuits is being offered in the "Princess" soldering iron. The new unit combines ultra-miniaturization with great thermal efficiency and work capacity.

For high-density circuits, flat or stack packs, and discrete components, the iron has a special series of subminiature copper or iron-clad soldering nibs, some drawn as fine as 0.005". In heat ranges, the user has a choice of 6-, 10-, 15-, or 18-watt heat capsules with temperatures from 450°F to 1000°F. Ungar

Circle No. 5 on Reader Service Card

GERMANIUM RECTIFIER

The new 1N91-93 germanium rectifier features an extremely low forward voltage drop

(0.45 V—for low power loss) plus high rectification efficiency (75% at 100 kHz).

According to the company, both performance characteristics of the 1-ampere device series are about 50% better than comparable low-current silicon rectifiers and are improvements over the ratings of a previously available, limited-source, JEDEC-registered 1-ampere germanium type.

Applications for the new units can be found in low-power circuits where voltage losses must be minimized, such as low-current battery charging and amplifier voltage biasing circuits. The new series is packed in the DO-13 flangeless case. Motorola

Circle No. 134 on Reader Service Card

NEW LASER

A "Q"-switched yttrium aluminum garnet (YAG) laser system, the Model LCW3, capable of pulse rates up to 5000 pulses per second has been put on the market. The laser is pumped continuously by two 1000-watt tungsten lamps in a double elliptical cavity. Output is at 1.06 microns and beam divergence is 4 milliradians. Rated lamp life is 500 hours. The LCW3 is water-cooled from ordinary tap water sources.

The compactly packaged laser is 8" x 5" x 21". It can be supplied with a stabilized d.c. power supply if extreme stability is required. An adjustable a.c. supply is ordinarily furnished, along with a small power supply for the "Q" switch. Raytheon

Circle No. 135 on Reader Service Card

FET FOR V.H.F. AMPS/MIXERS

The new 2N3823 "n"-channel FET offers extremely low cross-modulation and intermodulation distortion along with a guaranteed 100 MHz noise figure of 2.5 dB maximum. The drain and source are interchangeable, making it possible for the designer to choose the pin configuration best suited to his printed board layout.

Because of its low transfer capacitance of 2 pF maximum and low input capacitance of 6 pF maximum, the new device can also be used

A SELECTION OF ANNUALS STILL AVAILABLE

FROM THE WORLD'S LARGEST PUBLISHER OF SPECIAL INTEREST MAGAZINES



CAR & DRIVER YEARBOOK

A complete buyers guide covering virtually every car available in the United States . . . Road tests . . . Technical specifications . . . Accessories and performance equipment buying guide . . . Guide to racing with action-packed photos.

1966 — \$1.25..... #15
1965 — \$1.25.....#17



FLYING ANNUAL

The most valuable aviation yearbook ever compiled . . . Pilot reports . . . Aircraft directory . . . How to buy a used airplane . . . Navcom directory . . . Learn to fly section.

1966 — \$1.25.....#27
1965 — \$1.25.....#28



TAPE RECORDER ANNUAL

Everything you need to know about tape recording including a complete directory of mono and stereo recorders.

1966 — \$1.25.....#30
1965 — \$1.00.....#31



STEREO/Hi Fi DIRECTORY

Complete buyers guide for virtually every Hi Fi component manufactured.

1966 — \$1.25.....#29
1965 — \$1.00.....#37

Order by number from Ziff-Davis Service Division, 589 Broadway, N.Y., N.Y. 10012. Enclose add'l 15¢ per copy for shipping & handling (50¢ for orders outside U.S.A.)

BIGGER... BETTER THAN EVER!

FREE!



SEND TODAY FOR YOUR NEW 40th ANNIVERSARY 1967 CATALOG

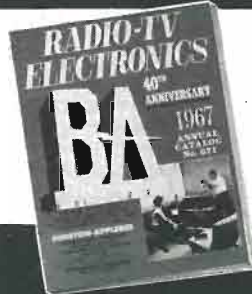

YOUR BUYING GUIDE FOR

- Stereo & Hi-Fi Systems & Components.
- Tape Recorders.
- Electronic Parts, Tubes, Tools.
- Phonos & Records.
- Cameras and Film.
- Public Address.
- Citizens Band. ● Ham Gear.
- Transistor & FM-AM Radios.

252 GIANT VALUE PACKED PAGES!

BURSTEIN-APPLEBEE CO.

Dept. EW, 1012 McGee, Kansas City, Mo. 64106
 Rush me the FREE 1967 B-A Catalog.

Name.....
Address.....
City.....
State..... Zip Code.....

CIRCLE NO. 124 ON READER SERVICE CARD

as a low-noise u.h.f. amplifier at frequencies up to 500 MHz.

The 2N3823 is housed in a standard TO-72 package. Motorola

Circle No. 136 on Reader Service Card

SOLID-STATE POWER SUPPLY

A low-cost solid-state power supply designed for a wide variety of applications is now available as the Model PS-200.

The unit employs zener-referenced voltage regulation and delivers 9 volts d.c. at loads up to 200 mA with complete dead short protection. A locking screwdriver-adjusted programming potentiometer permits the output voltage to be adjusted over a 1-volt range.

Specifications include: input voltage 105-125 volts a.c., 60 Hz, 5 watts; output voltage 9 volts

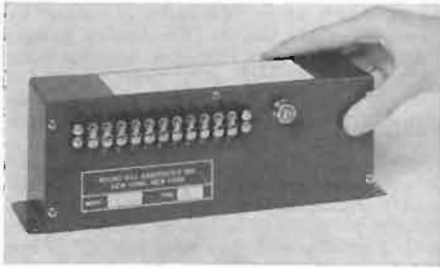

d.c.; maximum load current 200 mA. It is housed in an enameled steel case measuring 9" x 2 3/4" x 3 1/4". Weight is 44 ounces. Round Hill

Circle No. 137 on Reader Service Card

HIGH-ACCURACY A.F. BRIDGE

A new high-accuracy (0.01%) a.f. bridge which features electronic nulling and five-figure read-out for the resistive and reactive terms of any component or impedance/admittance is now on the market as the Model B331.

A discrimination of 10 parts per million is achieved on the B331 by combining three decades of push-button switches with continuous metering, giving an over-all measurement range of from 0.001 pF to 1 F; 100 μ ohms to 1000 kmeohms; and 0.01 μ H to 100 mH.

Lamps indicate the correct switching sequence for rapid backing-off until the settings for maxi-

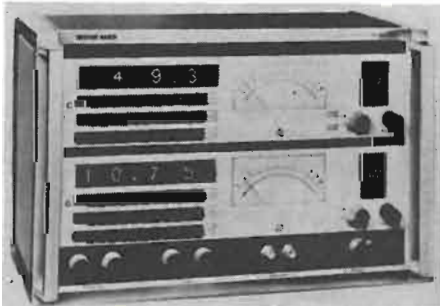

mum accuracy have been established. No search procedures are necessary and outputs are provided for recorders. Wayne Kerr

Circle No. 138 on Reader Service Card

COMPACT DEPTH SOUNDER

A compact "Fathometer" depth sounder, which measures 4 1/2 x 4 1/2 x 4 1/2 inches, has been developed especially for use in outboards and small inboards.

An easy-to-read dial on the Model DE-728 shows depth of water under the boat in one-foot steps up to 50 feet. A "vary-go-round" feature permits the outgoing ultrasonic signal to frequently yield second or third revolution readings over hard bottoms, allowing readings in water two or three times as deep as the rated 50-foot scale.

The depth sounder employs a compact transducer especially matched to the system. The transducer can be permanently installed through the hull of a boat, or it can be attached to a boat's transom for greater safety in boats that are



trailered or beached. The transom mounting bracket is included.

The DE-728 draws only 1/10th ampere from a 12-volt line or a separate battery. Raytheon

Circle No. 6 on Reader Service Card

H.F. VARIABLE AIR CAPACITOR

The new 5200 Series variable air capacitors provide improved rotational life, noiseless contact while adjusting, greater stability under shock and vibration, broader operating temperature range, and greater soldering ease, according to the manufacturer. These features are the result of a new one-piece rotor construction.

The new line features: capacity 0.8 to 10 pF; working voltage 250 V d.c.; temperature coefficient, 0 \pm 30 ppm/ $^{\circ}$ C; "Q" at 100 MHz of over 3000; sinusoidal vibration greater than 60 g's; random vibration greater than 2 g²/Hz; and shock greater than 275 g (6 milliseconds). The unit is constructed with 570 $^{\circ}$ solder. Johanson

Circle No. 139 on Reader Service Card

HI-FI—AUDIO PRODUCTS

SOLID-STATE AM-FM-STEREO TUNER

The new Model LT-325T solid-state AM-FM stereo tuner features IHF FM sensitivity of 2 μ V, plus i.f. rejection of better than -55 dB. The front panel includes an easy-to-read slide rule dial and illuminated d'Arsonval meter for pinpoint tuning accuracy.

The circuit uses 18 transistors and 17 diodes. Frequency response is 20-15,000 Hz \pm 2 dB; capture ratio is 3 dB; S/N is 60 dB at 98 MHz (100% modulation); and stereo separation is 35 dB at 400 Hz.

The tuner measures 13" x 3 3/4" x 9 3/8" and comes complete with a walnut-finish metal case. Lafayette

Circle No. 7 on Reader Service Card

SOLID-STATE GUITAR AMPLIFIER

The new "Ampli-Vox Baronet 890" is a portable, powerful solid-state guitar amplifier which operates from flashlight batteries and provides separate channels for microphone and instruments.

One set of ten "D" cells will provide a full year's service. An a.c. adapter is available for indoor use. Designed for portability, the 30-watt transistor amplifier and 9" oval speaker are housed in an attaché-type case which weighs only 16 pounds. Perma-Power

Circle No. 8 on Reader Service Card

8-TRACK CARTRIDGE MACHINE

The new "Duo-Vox" 8-track stereo tape player is designed to be used on the 12-volt battery systems of cars, boats, buses, trucks, and

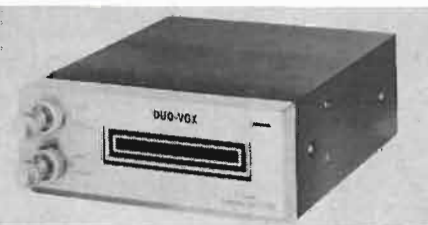

planes but with an accessory converter, it can be used on the power lines as well.

Standard 8-track cartridges will provide two hours playing time and then repeat automatically if desired. Tracks are changed by pressing a knob. A remote or foot control for track changing is also available.

The 13-transistor unit provides a frequency response of 60 to 10,000 Hz. It may be used with either two or four speakers. A variety of speakers for use with the system is available from the company. Duosonic

Circle No. 9 on Reader Service Card

BASS GUITAR SPEAKER SYSTEMS

Two new portable systems, engineered to obtain maximum performance from bass guitar amplifiers, are being marketed as the PMC-1 and PMC-2.

Both systems are about the size of a 2-suitcase. The PMC-1 has a 12" woofer and handles 60 watts while the PMC-2 has two 12" woofers and handles 120 watts. Utah

Circle No. 10 on Reader Service Card

RADIO/CASSETTE RECORDER

The Model L962 radio/cassette recorder permits recording up to 1 1/2 hours live from a microphone or direct from the AM-FM-shortwave portion of the radio. The radio will also play prerecorded tapes now available on the Philips and Mercury labels.

The cassette system plays at 1 7/8 ips while the radio is an AM-FM-shortwave-aircraft model. It has a full-range tone control plus automatic frequency control and extended coverage on short-

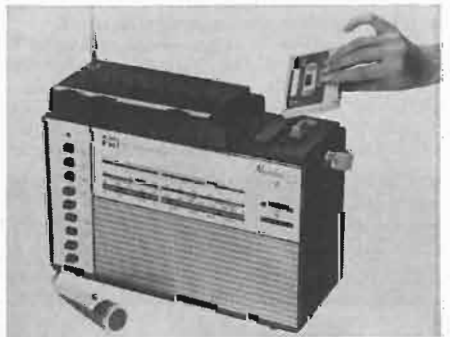

wave. A unique feature of this radio is separate volume controls for radio listening and tape recording. This feature allows a recording to be made direct from the radio either while listening or while the volume control of the radio is turned down.

The radio works on six flashlight batteries, measures 13 1/4" x 5 1/16" x 9", weighs 10 1/4 pounds with batteries, and comes complete with cassette, carrying case, and dynamic microphone. It is also a.c. adaptable. Norelco

Circle No. 11 on Reader Service Card

SOLID-STATE STEREO AMP/PREAMP

The TA-1120 is a solid-state stereo amplifier/preamplifier whose power amplifier section has an IHF power rating of 120 watts (both channels) at ohms and 200 watts at 4 ohms. Distortion is 0.05% at 1/2 watt and 0.1% at rated output. Internal damping is 140 at 16 ohms while the S/N ratio is better than 110 dB.

Frequency response is \pm 0 dB - 1 dB from 10 to 100,000 Hz. An SCR protects the transistors against damage due to accidental shorting.

The control preamp section features a functional arrangement of controls for maximum operating convenience. The unit comes in a metal enclosure with brushed aluminum panel. An optional walnut enclosure is available. Sony

Circle No. 12 on Reader Service Card

"UNIVERSAL" CARTRIDGE PLAYER

A unique tape cartridge unit which automatically adjusts to play any standard type or size tape cartridge has been introduced. The unit will handle both 4-track and 8-track tapes and



any of the three standard sizes of cartridges which are being used in car stereo players. The player will not handle the Philips cassettes or Orrtronic cartridges.

The tape cartridge unit is activated the moment a selector knob is set and the cartridge inserted. An exclusive electronic sensing device then automatically determines the type of cartridge and number of tracks. It also switches tracks automatically, shuts off both motor and amplifier at the end of the tape, and releases the cartridge. These 120-volt a.c. units are being incorporated in the firm's consoles and consoles.

Circle No. 13 on Reader Service Card

PRECISION TURNTABLE

A moderately priced automatic turntable, which incorporates many of the features previously found only in professional units, is now on the market as the "McDonald 500".

The 500 has a low-mass pickup which is so perfectly counterbalanced, both vertically and horizontally, that the entire turntable can be turned on the bias while playing without interrupting the record, according to its maker.

Stylus pressure is controlled by a micrometer-like pressure setting which permits precise $\frac{1}{8}$ gram adjustment from 0 to 6 grams. The pickup arm is supported on horizontal ball-bearing pivots which minimize vertical friction. The arm is also protected against accidental overloading with a uniquely designed mechanism which assures continued function of the arm even if it has accidentally locked down during the change cycle.

The turntable accepts either mono or stereo



cartridges and has an automatic lock which secures the arm to its rest whenever the machine turns off. BSR (USA) Ltd.

Circle No. 14 on Reader Service Card

CB-HAM-COMMUNICATIONS

COMMUNICATIONS RECEIVER

The new HA-700 communications receiver is a 6-tube superhet with two i.f. mechanical filters, a sensitive r.f. stage with front-panel antenna trimming, and continuous filament voltage on the oscillator/mixer stages to maintain frequency stability.

The silicon diode automatic noise limiter and a.v.c. circuitry provide efficient noise suppression. The built-in b.f.o. and product detection stages permit clear reception of c.w. and SSB signals. Electrical bandspread calibrated at 10 kHz per division on 80 meters, 5 kHz per division on 40 meters, and 50 kHz per division on 10, 15, and 20 meters makes the receiver easy to tune.

The receiver, which draws 45 watts at 110-117

V a.c., 50/60 Hz, measures $7\frac{7}{8}$ " x 15" x 10". Lafayette

Circle No. 15 on Reader Service Card

PORTABLE TRANSCEIVER

Boasting a receiver sensitivity of $0.75 \mu\text{V}$ for 10 dB signal-to-noise ratio, the 15-200 portable transceiver measures 6" x 6" x $1\frac{3}{4}$ ".

Features include two crystal-controlled channels with 2-watt output from 13 transistors; simple push-button operation throughout with "on-off" switch, preset volume control, squelch control, and channel selectors. It uses a combination speaker-microphone with push-to-talk switch.

For portable operation, the unit uses 8 "AA" batteries or cadmium equivalents. It comes complete with 4 crystals (2 transmit and 2 receive) and dynamic microphone-speaker. Claricon

Circle No. 16 on Reader Service Card

SOLID-STATE COMMUNICATIONS RECEIVER

The new DR-30 communications receiver is a compact, high-performance, dual-conversion, solid-state superhet unit for amateur and other applications. The use of FET's in the r.f. stages of the DR-30 is said to provide greater sensitiv-



ity, better image rejection, and exceptional freedom from cross-modulation or overloading on strong signals.

All of the circuitry is contained on nine plug-in, glass-epoxy modules for easy access and a rugged $\frac{3}{16}$ " thick aluminum extrusion used for the chassis provides rock-like stability. The receiver offers complete ham-band coverage, 80 through 10 meters plus a portion of 6-meter band; 9.5-10.5 MHz for WWV and 31-meter SWL band plus provision for two optional crystals for additional frequency coverage. The receiver measures 4" x $7\frac{1}{8}$ " x 6". Davco

Circle No. 17 on Reader Service Card

MOBILE-TYPE MICROPHONE

To supplement the firm's transistorized "+2", the first microphone with a volume control, the "M+2", a mobile-type unit, has been put on the market. The "M+2" is designed especially for mobile applications where more output may be needed or where variable output level is desirable.

The microphone features fingertip volume control, self-contained two-transistor preamp, and a 300-3500-Hz voice response range. An electronic switching model is also available at no extra cost. The unit comes complete with battery, dash bracket, and 5-foot coiled cord. Turner

Circle No. 18 on Reader Service Card

CB TRANSCEIVER

A compact, transistorized CB transceiver with new crystal socket accessibility and solid-state switching has been introduced as the "Slimline 675".

The new unit is a 10-channel, 5-watt transceiver which allows the addition of transmitter and receiver crystals merely by removing three knobs and two shaft nuts from its front-panel controls. The panel can then be lifted away, exposing the bank of crystal sockets and the channel indicator dial.

The 675 measures only $2\frac{1}{2}$ " high by $6\frac{1}{2}$ " wide by 9" deep and has a built-in p.a. system. Amphenol

Circle No. 19 on Reader Service Card

MANUFACTURERS' LITERATURE

POWER SUPPLIES

A new 82-page catalogue and application manual on regulated d.c. power supplies is now available to systems engineers, circuit designers, and electronic packaging engineers.

Containing complete specs on the company's line of high-, medium-, and low-voltage rack and bench supplies, the booklet also includes a 32-page illustrated section that covers power-supply circuit principles, operational features and options, special application problems, and definitions and measurements. Hewlett-Packard/Harrison Div.

Circle No. 140 on Reader Service Card

COAX INSTALLATION

A new 16-page illustrated booklet describing installation procedures for all coaxial cable types manufactured by the company has been issued.

Covering Styroflex, foamflex, and helical membrane cables, the publication (Bulletin IP-2) discusses cable-cutting tools, reel handling, cable-cutting and lashing techniques, testing, leak detection, and three types of installation (aerial, tower, and underground).

The new booklet is a complete revision and updating of a similar manual on coaxial cable (Bulletin IP-1) that was published some years ago. Phelps Dodge

Circle No. 20 on Reader Service Card

INSTRUMENT MOTORS

A line of reluctance synchronous, hysteresis synchronous, induction, and servo control motors is described and illustrated in a new 8-page catalogue. Listed in the booklet is a wide range of output speeds and torques available for recorder and control applications. Amphenol

Circle No. 141 on Reader Service Card

AIR CAPACITORS

A new line of microminiature, high-"Q" variable air capacitors (Series 4700) is fully described in a new catalogue sheet.

Featuring coin silver and gold-plated brass construction, glazed-alumina insulation, and silicone rubber seals, the capacitors are available in printed-circuit, lug terminal, and turret terminal configurations. Johanson

Circle No. 142 on Reader Service Card

SOLDERING COPPER WIRE

Complete information on the technology of soldering the fine copper wire used to manufacture microcircuit devices is contained in a new 4-page bulletin (TR-1018).

Discussed in the booklet are types of alloys and fluxes, magnet-wire stripping, various copper-wire manufacturing methods, and design considerations. Alpha Metals

Circle No. 143 on Reader Service Card

FRACTIONAL H.P. MOTORS

A wide range of fractional horsepower motors for industrial applications is featured in a new 16-page illustrated catalogue. Special- and general-purpose devices, laundry equipment units, direct-drive blower types, and motors specially designed for room air conditioners, refrigerators, oil burners, and jet pumps are covered in the booklet. Emerson

Circle No. 144 on Reader Service Card

FUSE HOLDERS

A new 4-page condensed catalogue which describes a variety of military-approved indicating and non-indicating fuse holders along with several non-military indicating types has been released.

The illustrated booklet also lists a number of blown-fuse indicators. Fuse Indicator

Circle No. 145 on Reader Service Card

LAMINATED WIRE

Information on a complete line of fused, high-temperature, Teflon-laminated wire and cable is

PERMANENT PROTECTION!



Electronics World

Deluxe Magazine Files that hold a full year's copies!

Designed to keep your periodicals orderly and easy to refer to. These durable files guard against soiling, tearing, wear or misplacement of issues. They look, feel like leather and are washable! 23kt. gold lettering and exquisite 2-color binding make them highly-decorative additions to your bookshelves.

Shipped POSTPAID! FULLY GUARANTEED!
Only **\$3.50 each—3 for \$10, 6 for \$19**

Order several today—for ELECTRONICS WORLD and all your other favorite magazines.

Jesse Jones Box Corp., Box 5120, Dept. EW Philadelphia 41, Pa.

Enclosed is \$_____ Please send me _____ Electronics World Magazine Files in the colors checked below:

Black backing/maroon sides
 Maroon backing/black sides

NAME _____
ADDRESS _____
CITY _____ STATE _____ ZIP CODE _____

Orders outside U.S.A. please add \$1 additional for each file ordered.

(Payment must accompany order)

COMPLETE TUNER OVERHAUL

ALL MAKES ALL LABOR AND PARTS (EXCEPT TUBES & TRANSISTORS) **9.95**

Send complete tuner now... or write for full information and mailing labels. Exchanges on tuners unfit for overhaul... from \$12.95

CASTLE TV TUNER SERVICE

MAIN PLANT: 5717 N. Western Ave., Chicago 45, Illinois
EAST: 41-84 Vernon Blvd., Long Island City 1, New York
Castle TV Services, Ltd. . . . Nation-wide service.

CANADA: For service in Canada write to Chicago for details, Canadian address, and mailing kit.
*Major parts are charged extra in Canada

"HOW TO MAKE MONEY IN Mobile Radio Maintenance"

AUTHORITATIVE GUIDEBOOK ABOUT THE BOOK IN TWO-WAY MOBILE RADIO! GIVES FACTS, FIGURES, PAY RATES. WRITE TODAY! **FREE**

LAMPKIN LABORATORIES, INC. MFM Div. BRADENTON, FLA.

LEARN Electronics Engineering AT HOME

Fix TV, design automation systems. Learn transistors, complete electronics. College level Home Study courses taught so you can understand them. Earn more in the highly paid electronics industry. Computers, Missiles, theory and practical. Kits furnished. Over 30,000 graduates now employed. Resident classes at our Chicago campus if desired. Founded 1934. Catalog. "Vets—write for information about G.I. Bill Training."

American Institute of Engineering & Technology
1141 West Fullerton Parkway Chicago, Ill. 60614

BARGAIN HUNTING? FREE! GIANT SENSATIONAL ELECTRONICS CATALOG

HENSHAW TV SUPPLY
3617 TROOST, KANSAS CITY, MO.

contained in a new 20-page illustrated booklet. Products covered include miniature instrument wire, hookup wire, low-bulk power conductors, and shielded and Teflon-jacketed cables.

Featured in the publication is a series of tables comparing the company's light wall insulation with conventional insulations in terms of size and weight. In addition, there are sections on useful wire formulas and American Wire Gauges as well as a wire stranding chart. Inso

Circle No. 146 on Reader Service Card

TOOL SETS

A new illustrated catalogue sheet describing three color-coded "Tray Bien" nutdriver sets in molded plastic trays has been issued. Each set contains seven tools, either solid-shaft or hollow-shaft, in a variety of hex openings. Xcelite

Circle No. 21 on Reader Service Card

PLASTIC FASTENERS

An expanded 20-page illustrated catalogue (No. 110) covering a wide variety of plastic fasteners is now available. Listed in the booklet are screws, bolts, nuts, and washers made of nylon, Teflon, polyethylene, polystyrene, and other plastics. Product Components

Circle No. 147 on Reader Service Card

FET APPLICATIONS

Twenty-one different circuits, all employing FET's, are presented in a new 4-page pamphlet entitled "FET Circuit Ideas."

Included are a number of amplifiers, preamplifiers, and oscillators, as well as a voltmeter, timer, hi-fi tone control, phase shifter, and micro-power flip-flop. Siliconix

Circle No. 148 on Reader Service Card

SHOWROOM ALL-CHANNEL TV

The benefits to the TV and appliance dealer of single-cable distribution systems that carry v.h.f., u.h.f., and FM programs over the same channel are outlined in a new 4-page illustrated brochure (DS-C-017).

Included in the booklet are typical schematic layouts for all-channel TV showroom systems as well as several special applications. Jerrold

Circle No. 22 on Reader Service Card

CAPACITOR RELIABILITY

Tantalum-foil capacitor reliability is the subject of a new 26-page illustrated report (No. GET-2998). The publication defines reliability, discusses methods of determining failure rates, and lists various product features and capabilities that contribute to reliability.

Featured in the brochure is a 4-page statement on the company's quality-control policy. General Electric

Circle No. 149 on Reader Service Card

COUNTER PLUG-IN

Information on the Type DP-140 event counter and slave plug-in is offered in a new illustrated catalogue sheet. Fully transistorized and providing three-digit all-electronic display, the unit is designed for use with the company's DMS-3200 digital measuring system to permit extension of the system's frequency-measurement and event-counting capability. Hickok

Circle No. 23 on Reader Service Card

INTEGRATED CIRCUITS

Design data and applications for seventeen DTL circuits are contained in a new 24-page booklet on SE100J-Series IC's. A 9-page section is devoted to characteristic curves, including design limit curves, for all elements of the series.

In addition, the brochure contains block diagrams of typical subsystem applications, including a switch-bounce eliminator, several shift registers, and a synchronous decade counter. Signetics

Circle No. 150 on Reader Service Card

TEST INSTRUMENTS

A line of panel and portable electrical and

electronic test instruments is described and illustrated in a new 12-page catalogue (No. 49-T). Covered in the booklet are a wide range of volt-ohm-milliammeters, tube and transistor analyzers, and various accessories. Triplett

Circle No. 24 on Reader Service Card

WIRING BOOKLET

A new pocket-sized 26-page booklet entitled "Helping Hand for Electrical Wiring" is now available. The brochure discusses electricity, types of circuits, resistance, splices, and a variety of terminals. Typical installations are illustrated, and a handy 7-page glossary of terms is provided. Vaco

Circle No. 151 on Reader Service Card

AUDIO PRODUCTS

A line of audio accessories, including audio mixers, speaker controls, couplers, adapters, selector switches, molded cable assemblies, and a wide range of connectors, is described and illustrated in a new 14-page catalogue (No. A-401b). Switchcraft

Circle No. 25 on Reader Service Card

TEST EQUIPMENT

Information on the "Commander" line of color-TV test equipment is offered in three new illustrated catalogue sheets. Features, accessories, and applications of a cathode-ray-tube checker/rejuvenator, a field-strength meter, and a color generator are covered. Amphenol

Circle No. 26 on Reader Service Card

MILITARY SWITCHES

Comprehensive selection charts covering one-hole mounted switches that conform to various military specifications have been issued.

Reference data on positive-action and miniature positive-action switches in single-, double-, and four-pole configurations is supplied, as well as information on rotary types, special service devices, and switch guards. Cutler-Hammer

Circle No. 152 on Reader Service Card

PHOTO CREDITS

Page	Credit
14	Kenwood Electronics, Inc.
27	Magnovox
30	TelePro Industries, Inc.
31	Lear Jet Corp.
32	Norelco
38, 40, 41 (bottom)	Texas Instruments
41 (top), 42	Motorola, Inc.
44, 45	General Electric Co.
68	Triplett
70	Eico Electronic Instrument Co., Inc.
72	Acopion
89, 90, 92	Jerrold Electronics Corp.
95	Marantz Co., Inc.

Answer to Crossword Puzzle appearing on page 77

V	E	C	T	O	R	D	I	A	G	R	A	M
A	A	E	R	M	M	I						
L	A	S	E	R	I	N	P	U	T	C		
V	C	S	H	F		P	R	R				
E	A	S	T	A	T	I	C	E	C	O		
S	A	D	E	M	M	D	B	N				
	L	E	A	D	L	A	L	F				
T	E	F	T	O	G	G	L	E	S			
R	S	H	I	D	E	X	A	C				
I	S	O	T	O	P	E	S	Y	R			
O	W	N	T					M	A	L	E	
D	I	P						M	M	A	G	E
E	N	C	A	P	S	U	L	A	T	I	O	N

SCOPE D.C. SHIFT

By DONALD LUDWIG

WHEN observing a waveform on a d.c.-coupled oscilloscope, an error due to the d.c. shift of the trace may occur which may cause the observed waveform to be misinterpreted.

Such a d.c. shift could occur when a d.c. potential, or a step function, is applied to the scope's vertical amplifier input. The trace may be deflected beyond the applied voltage level and may require as much as several seconds to drift back to the applied voltage level and stabilize in that position. Such a d.c. shift is shown in Fig. 1. This problem is often overlooked when calibrating or using a d.c. scope.

To detect any d.c. shift requires only a v.o.m. and several seconds. First, set the sweep controls for a reasonable sweep speed and to extend the trace the full length of the screen. Then, set the vertical amplifier gain to permit sufficient vertical deflection of the trace in response to the v.o.m. output voltage.

Position the scope trace on the bottom line of the CRT graticule, then select a resistance range on the v.o.m. that will produce a vertical deflection of approximately full screen height.

Connect the v.o.m. common lead to the scope ground terminal and the positive lead to the scope vertical input.

As the leads are attached to the scope terminals, watch the movement of the trace.

If it rises to the applied voltage level and remains there, no d.c. shift is present. If the trace rises above the applied level and requires some time to drift back and stabilize at the applied voltage, d.c. shift is present.

In some cases, a small amount of d.c. shift may be expected due to oscilloscope manufacturing tolerances, and the scope manufacturer's manual should be consulted if the error appears large.

Such d.c. shift may be due to improper scope alignment or a faulty component (usually a tube) in the oscilloscope vertical amplifier. ▲

Fig. 1. When a step function is applied to the input of a d.c. coupled amplifier, the d.c. shift shown usually occurs when the circuit (usually tubes) is faulty.

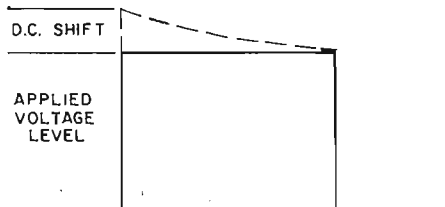

2 Complete Tube Testers In 1 Instrument

1. RECEIVING TUBE TESTER
- plus:
2. TV PICTURE TUBE TESTER

**SAVE MORE
THAN \$50!**

(compared to buying two separate testers)



Precise's New 'GREEN LINE' Model 115

\$9295 Net

1. RECEIVING TUBE TESTING

Eliminates Obsolescence Problem! A unique 10-circuit switching design allows testing of all the new type tubes that have elements with multiple pin connections—the Model 115 is the first and only obsolete-proof receiving tube tester in the speed-type class. ■ Grid emission test provides a sensitive grid emission and gas check by the use of built-in balanced VTVM circuitry. This all-important feature provides a revealing and significant tube condition test. ■ Basic dynamic cathode emission test is supplemented by a hot cathode shorts and leakage check. ■ Includes all latest type sockets, plus pin straighteners.

2. TV PICTURE TUBE TESTING & REJUVENATION (B&W and COLOR) •

The basic picture tube test (for each gun of color picture tubes, and the single gun of B&W tubes) is picture-producing beam current (not total cathode emission which is rarely indicative of picture brightness). The beam current test checks all picture tubes for proportionate screen brightness. The critical central area of the picture tube cathode is checked in addition to the controlling action of the first grid. ■ Rejuvenation of picture tubes is accomplished by a unique capacitor discharge circuit which welds most intermittent elements, and redistributes cathode oxide over the beam-producing central cathode area. Meter directly indicates increase in brightness after each rejuvenation "shot".

GENERAL DATA

Wide visibility, 2% accuracy meter includes separate scales for quality test, grid emission, and picture tube beam current. ■ Complete up-to-date data book supplied. New data constantly available. ■ Size 16" x 9" x 4 3/4". Weight 8 pounds. ■ ACCESSORIES AVAILABLE: Model CTA Color Tube Socket Adapter, \$6.50 Net.

See the complete "GREEN LINE"—power supplies, scopes, VTVMs, signal generators, tube testers, decade boxes, probes—at your local distributor, or write direct for full information and specs.



PRECISE ELECTRONICS

Division of Designatronics Incorporated

76 East Second Street, Mineola, L. I., New York

ENGINEERED EXCELLENCE IN TEST EQUIPMENT

CIRCLE NO. 81 ON READER SERVICE CARD



MODEL 1/4 TRACK STEREO
SX724 ONLY \$975 **DUO STATE**

NEW!

Modular Transport
Low-Noise Circuitry
Third Head Monitoring

World's Finest Recording Quality

Speed	Response	S/N
7-1/2	±2db 30 to 25,000	55db
3-3/4	±2db 30 to 15,000	50db

Crown International
BOX 1000, DEPT. EW-11
ELKHART, INDIANA

MADE ONLY IN AMERICA

CIRCLE NO. 78 ON READER SERVICE CARD



FREE

Fill in coupon for a **FREE** One Year Subscription to **OLSON ELECTRONICS' Fantastic Value Packed Catalog**—Unheard of **LOW, LOW PRICES** on Brand Name Speakers, Changers, Tubes, Tools, Stereo Amps, Tuners, CB, Hi-Fi's, and thousands of other Electronic Values. Credit plan available.

NAME _____
ADDRESS _____
CITY _____ STATE _____ ZIP _____

If you have a friend interested in electronics send his name and address for a **FREE** subscription also.

OLSON ELECTRONICS, INC.

528 S. Forge Street Akron, Ohio 44308

CIRCLE NO. 98 ON READER SERVICE CARD

ELECTRONICS MARKET PLACE

COMMERCIAL RATE: For firms or individuals offering commercial products or services. 70¢ per word (including name and address). Minimum order \$7.00. Payment must accompany copy except when ads are placed by accredited advertising agencies. Frequency discount: 5% for 6 months; 10% for 12 months paid in advance.

READER RATE: For individuals with a personal item to buy or sell. 40¢ per word (including name and address). No Minimum! Payment must accompany copy.

GENERAL INFORMATION: First word in all ads set in bold caps at no extra charge. Additional words may be set in bold caps at 10¢ extra per word. All copy subject to publisher's approval. **Closing Date:** 1st of the 2nd preceding month (for example, March issue closes January 1st). Send order and remittance to: Hal Cymes, **ELECTRONICS WORLD**, One Park Avenue, New York, New York 10016

FOR SALE

JUST starting in TV service? Write for free 32 page catalog of service order books, invoices, job tickets, phone message books, statements and file systems. Oelrich Publications, 6556 W. Higgins Rd. Chicago, Ill. 60656.

GOVERNMENT Surplus Receivers, Transmitters, Snooperscopes, Radios, Parts, Picture Catalog 25¢. Meshna, Nahant, Mass. 09108.

INVESTIGATORS, FREE BROCHURE, LATEST SUBMINIATURE ELECTRONIC SURVEILLANCE EQUIPMENT. ACE ELECTRONICS, 11500-J NW 7TH AVE., MIAMI, FLA. 33168.

CANADIANS—Giant Surplus Bargain Packed Catalogs. Electronics, Hi-Fi, Shortwave, Amateur, Citizens Radio, Rush \$1.00 (Refunded). ETCO. Dept. Z, Box 741, Montreal, Canada.

JAPAN & Hong Kong Electronics Directory. Products, components, supplies. 50 firms—just \$1.00. Ippano Kaisha Ltd., Box 6266, Spokane, Washington 99207.

TRANSISTORS —Miniature Electronic Parts. Send for Free Catalog. Electronic Control Design Company, P.O. Box 1432M, Plainfield, N.J.

CANADIANS, transistors, all semiconductors and components. Free catalogue contains reference data on 300 transistor types. J.&J. Electronics (Dept. EW), P.O. Box 1437 Winnipeg, Manitoba, Canada.

METERS—Surplus, new, used, panel and portable. Send for list. Hanchett, Box 5577, Riverside, Calif. 92507.

MESHNA'S TRANSISTORIZED CONVERTER KIT \$5.00. Two models—converts car radio to receive 30-50 mc or 100-200 mc (one mc tuning). Meshna, North Reading, Mass. 01864.

R.F. CONVERTERS World's largest selection. Also CCTV cameras, transmitters, etc. Lowest factory prices. Catalog 10¢. Vanguard, 196-23 Jamaica Ave., Hollis, N.Y. 11423.

CONVERT any television to sensitive big-screen oscilloscope. Only minor changes required. No electronic experience necessary. Illustrated plans, \$2.00. Relco-A22, Box 10563, Houston 18, Texas.

ELECTRONIC Ignition Kits, Components Free Diagrams. Anderson Engineering, Epsom, New Hampshire 03239.

FREE ELECTRONICS (new and surplus) parts catalog. We repair multimeters. Bigelow Electronics, Bluffton, Ohio 45817.

SURVEILLANCE EQUIPMENT—NEW HIGH PERFORMANCE SUBMINIATURE MODELS. ELECTRONIC COUNTERMEASURE DEVICES TO PROTECT PRIVACY. FREE DATA: SECURITY ELECTRONICS-EW, 15 EAST 43RD STREET, NEW YORK, N.Y. 10017.

DETECTIVES! Free brochures! Electronic Surveillance devices. SILMAR ELECTRONICS, 3476 N.W. 7th Street, Miami, Florida 33125.

CRYSTALS . . . largest selection in United States at lowest prices. 48 Hr. delivery. Thousands of frequencies in stock. Types include HC6/U, HC18/U, FT-241, FT-243, FT-171, etc. Send 10¢ for catalog with oscillator circuits. Refunded on first order. Jan Crystals, 2400E Crystal Dr., Fort Myers, Fla. 33901.

DIAGRAMS, service information, Radio \$1.00, Television \$2. BEITMAN, 1760 Balsam, Highland Park, Illinois 60035.

WHOLESALE: Microphones 89¢, Speakers 49¢, Amplifiers \$4.39. Hundreds of items. Catalog 25¢. Royal, 8632 La Mesa Blvd., La Mesa, Calif.

NEW supersensitive transistor locators detect buried gold, silver, coins. Kits, assembled models. \$19.95 up. Free catalog. Relco-A22, Box 10563, Houston 18, Texas.

McGEE RADIO COMPANY. Big 1966-1967 catalog sent free. America's best values. HiFi amplifiers—speakers—electronic parts. Send name, address and zip code number to McGee Radio Company, 1901 McGee Street, Dept. EG, Kansas City, Missouri 64108.

USED TEST EQUIPMENT. VTVM'S, OSCILLOSCOPES, SIGNAL GENERATORS. LOW PRICES. COME SEE. REX, 759 10th Ave., NEW YORK, NEW YORK 10019.

R.C.A. Transconductance type tube tester Model WT100A. Good condition \$100. Rozman, 18 Maple Avenue, Ellenville, New York 12428.

STEREO for sale. 3 Components Harmon Kardon Citation III and tuner. Harmon Kardon Citation IV Pre-Amp, Dynakit 35 stereo amp. Original value \$578. Will accept \$255.00. Write 10310 Malcolm Circle, Cockeysville, Md.

WARNING Burglar Alarm Decals two for \$1.00. Protect your home or business. Used Radar Alarms, phone dialers. Information. Reid's Electronics, 1221A East Van Buren, Phoenix, Arizona 85008.

TRANSISTORIZED Products Importers catalog. \$1.00. Intercontinental. CPO 1717, Tokyo, Japan.

GREGORY ELECTRONICS Reconditioned & Used FM 2-WAY RADIO SAVINGS

Partial list—Send for Fall '66 catalog

Voice Commander



132 to 172 MC, 1W 9.5" x 5.3" x 1.7" Reduced price including brand New Rechargeable Nickel Cadmium Battery Pack

Lowest Price Ever!

\$148

If crystal & tuning is desired add \$45.00
Battery charger for these units \$16.00

WRITE FOR QUANTITY PRICES

VOICE COMMANDER

Monitor Receiver only—Tuned & Crystalled with dry Batteries

\$78

MOTOROLA 30-50mc



T-51GGV

Vibrator Power Supply
6/12v 50-60 watts

Same unit tuned to desired frequency, including new antenna, add \$45.

Complete with all accessories, less crystals and antenna.
Wide Band TX Narrow, RX Wide **\$188**
Transmitter & Receiver Fully Narrow Banded **\$208**
(Less accessories, deduct \$30.00)

GE TX 4ET5
6 v 30 watt 40-50mc..... **\$10**

GE TX 4ET5
12 v 30 watt 40-50mc..... **\$15**

We Buy Late Model Equipment for Cash
—Write: Wire or Phone!



GREGORY ELECTRONICS CORPORATION

249 RT. 46, Saddle Brook, N.J., 07662
Phone: (201) 489-9000

CIRCLE NO. 112 ON READER SERVICE CARD
ELECTRONICS WORLD

RECTIFIERS & TRANSISTORS

Silicon Diodes

Amps	100 PIV	200 PIV	400 PIV	600 PIV
.75*	.07	.10	.14	.21
3	.14	.22	.28	.40
15	—	.75	1.20	1.55
35	—	1.30	2.00	2.70

Amps	700 PIV	800 PIV	900 PIV	1000 PIV
.75*	.25	.32	.40	.55
3	.49	.58	.67	.78
15	1.70	1.85	2.25	4.80
35	3.15	3.60	4.50	7.80

10 Watt Sil. Zener Stud 20% 12-200V .95¢ ea.
1 Watt Zener, axial 20%, 8-200V .50¢ ea.
Sil. diode Stud, 1500 piv, 300 ma. .50¢ ea.
Hoffman Sil. Epoxy diodes, 200 ma.
3000 PIV98¢ 6000 PIV. \$2.49
Thermistor bead, 900 or 1200 ohm, 600°F. .2/\$1.00

Silicon Power Transistors

4W, 2n498, TO-550¢
15W, 2n2990, TO-585¢
30W, 2n151, TO-601.25
40W, 2n1047, TO-571.40
50W, 2n1722, TO-631.50
50W, 2n1724, TO-611.50
2n1300 series, NPN or PNP6/\$1.00
Sil. Junction diodes, 1N200 series.15/\$1.00
70 amp. stud, 50 PIV—\$2.50, 100 PIV—\$3.50
Amplifier, 6 Tubes, new, 3 lbs. \$1.49
Nickel Cadmium Battery, 9 1/2 oz. 8 amp hr. . \$2.50
10 Lbs. Power Resistors, 5-60W. \$1.98
10 Lbs. Paper Capacitors, assorted. \$1.98
IN34A12/\$1.00
2 Watt Pots, assorted.15/\$1.00
Mercury Batteries, 5.4V, 5/8"x1"4/\$1.00
100—1/4 w resistors, assorted \$1.98
50 W. Zeners 12, 14, 16, 18 \$2.00 ea.
50 disc cap, assorted98¢
Computer Boards, parts free—Transistors. .8¢ ea.

Varicap-Voltage Variable Capacitor

27, 47, or 100 pf at 4v, 4:1 \$1.25
150 W Germanium Power (Diamond Case)
2n1021. . . \$1.00 2n1022. . \$1.25 2n511. . \$1.50
20 W Germanium Power (internal heat sink)
2n1038 4/\$1.00 2n1039 3/\$1.00 2n1040 2/\$1.00
2n1041 60¢ Add 10¢ ea. for external heat sink

SILICON CONTROLLED RECTIFIERS

PRV	.75A*	7A	16A.	PRV	.75A	7A	16A.
25	—	.48	300	1.20	1.80	2.20	
50	—	.45	400	1.70	2.20	2.70	
100	—	.70	500	1.95	3.00	3.30	
200	.80	1.15	600	2.30	3.20	3.90	

*Top Hat, others Stud
Money back guarantee. \$2.00 min. order, include postage. Write For Free Catalog. C.O.D. 25¢

Electronic Components Co.
Box 2902, Baton Rouge, La. 70821

CIRCLE NO. 117 ON READER SERVICE CARD
106

U.S. GOV'T ELECTRONIC SURPLUS

Nationally Known-World Famous SURPLUS CENTER offers finest, most expensive, Government Surplus electronic units and components at a fraction of their original acquisition cost.

ORDER DIRECT FROM AD or WRITE FOR CATALOGS

LABORATORY EXPERIMENTAL KIT

PERFORM 100'S OF FASCINATING ELECTRICAL EXPERIMENTS

Gov't Acquisition Cost Of Paris Over \$50.00

\$14.85 F.O.B.



(ITEM HA222) - Amazing Value! Valuable gift for son or husband. Hundreds of fascinating experiments. Teaches modern electronic theory and practice. Easy, interesting way to learn.

Experiment with electro-plating, electro-magnetic phenomena, resonance, burglar alarm, relay circuits, rectification, test circuits, capacitor, motor experiments, transformer phenomena, etc.

Kit Contains: DC motor, AC motor, electro-magnetic coils, and DC relays, set of lab capacitors, compass, test bulbs, plating chemicals, silicon diodes, germanium diode, burglar alarm actuator, carbon microphone eavesdropping element, ac test sockets, permanent magnets, telephone handset, cords, test clips, wire, and other items. Over 35 pieces. Includes fine Experimental Manual with drawings, procedures, etc., written by professional engineers.

Also furnished with each kit our popular book Home Laboratory Bench and Experimental Procedures, (Reg. \$1.00). Shows how to build wonderful home laboratory test bench, and how to get the most out of your experimental work. (12 lbs.) Paris cost gov't over \$50.00.

AC PROGRAM TIMING CLOCK

(ITEM H158) - Zenith 115-VAC program timer. Use for periodic signaling, work breaks, school classes, turn on radio for news, etc. Adjustable clips permit switching On or Off any time during 24-hour period. Sufficient clips for multiple programming. Also has "skip-ahead" feature. Contacts can handle up to 15-amps. 8 1/2" x 6 1/2" x 4". Wt. 8 lbs. Gov't Cost Over \$30.00.

Instructions Furnished. F.O.B. **\$9.49**



AUTO-PILOT GYROSCOPE

(ITEM H115) - DC motor driven, gimbal mounted gyroscope. Ultra-expensive precision unit used to "steer" large, multi-engine planes. Deviation from established plane sends potentiometer controlled signals to bring about change in other motors. Unit can be used as auto-pilot for boats. Wonderful class room unit to demonstrate and study gyro action. Missiles, planes, boats all use gyros. Size 9" x 8" x 10". Wt. 21 lbs. Cost Gov't Over \$500.00.

F.O.B. **\$12.47**



STANDARD DIAL TELEPHONE

(ITEM H116) - Standard, commercial telephone same as used throughout U.S.A. Attractive polished black, like new condition. Use as extension phone to private system or connect several phones together for local intercom system. Full instructions are furnished. Wt. 9 lbs. Original Cost \$24.50.

F.O.B. **\$5.95**



STEP-BY-STEP AUTOMATIC SWITCH

(ITEM H738) - Amazing "up-and-around" electro-magnetic telephone switch. Dial any bank pair from 1 to 100. Make your own telephone system. Can also be used to remotely control up to 100 circuits over a single pair of wires.

One of our FOUR STAR bargains. Comes complete with dial, one line and one line bank. Size: 5 1/2" x 7 1/2" x 1 1/2". Wt. 16 lbs. Cost Gov't Over \$75.00. Complete; Switch cover, dial, line bank, instructions..... F.O.B. **\$9.95**



STEP UP/DOWN TRANSFORMER

(ITEM H1543) - Step voltage up or down. Has many uses. Will step 115-volts up to 230-volts or step 230-volts down to 115-volts. Will also transform 115-volts to 55-volts. Rated 1.75 amps. output with 175-watt capacity. Size... 4 1/2" x 3 1/2" x 2". Wt. 4 lbs. Gov't Cost \$12.75.

F.O.B. **\$4.99**



TYPICAL BUYS FROM OUR 1967 CATALOGS

- \$ 350.00 - Geared 2-hp Battery Golf Car Motor **\$24.95**
- \$ 15.00 - Westinghouse DC Ammeter, 0 to 300 **\$ 7.11**
- \$ 40.00 - Vacuum/Pressure Pump, 12-VDC **\$11.95**
- - - 80-MW Walkie-Talkies, Per Pair **\$19.60**
- - - Deluxe, Multi-Range, AC/DC Tester **\$ 8.98**
- \$4000.00 - Carrier Telephone Amplifier System **\$13.91**

SPECIAL SALE

Correspondence Course In ELECTRICAL ENGINEERING



Sells For \$10.79 Outside U.S.A. **\$ 8.79** Postpaid In U.S.A.

(ITEM HA181) - Wonderful chance to obtain technical training at Amazing Low Cost! Lincoln Engineering School has suspended its Correspondence Courses because of increased operating costs. We offer a limited number of the school's complete Electrical Engineering Course but without the examination paper grading service. The course consists of 14 lesson unit books. Each book has the regular exams, and in a separate section, "Standard Answers" to each exam question.

Course is well written, easy to understand, profusely illustrated. Reader's Digest size, easy to carry and study in spare time. Many Lincoln Engineering School students holding excellent jobs as a result of E.E.S. training. Course contains latest information on transistors, silicon diodes, etc. Additional book on how to build and operate a "Home Laboratory and Experimental Bench" furnished with each course.

SEND 25c COIN OR STAMPS FOR 3 MAIN CATALOGS

All Items FOB Lincoln Money Back Guarantee

SURPLUS CENTER

DEPT. EW-116 LINCOLN, NEBR. 68501

DON'T WONDER who you talked to, write it down. Record book for CB'ers. Rush stamp for sample page or \$2.00 postpaid. Alameda Publishing, 9128 N. 4th, Albuquerque, N.M. 87114.

TUBE TESTER \$9.00. Shell model 102 tester panel, 7*0-Ima meter, 102 sockets, vibrator tester, 18" wide x 16" high. EVEREADY battery tester, \$4.00. Money back guarantee. Kirby, 3606 Delmar Road, Indianapolis, Indiana 46220.

ELECTRONICS ENGINEERING AND INSTRUCTION

FCC LICENSE in six weeks. First class radio telephone. Results guaranteed. Elkins Radio School, 2603C3, Inwood, Dallas, Texas.

ELECTRONICS! Associate degree—29 months. Technicians, field engineers, specialists in communications, missiles, computers, radar, automation. Start September, February. Valparaiso Technical Institute, Dept. N, Valparaiso, Indiana.

F.C.C. LICENSE (first class) in seven weeks. Resident classes or correspondence. Grantham, 1505 N. Western, Hollywood, California 90027.

REI First Class Radio Telephone License in (5) weeks Guaranteed. Tuition \$295.00. Job placement free. Radio Engineering Institute, 1336 Main Street, Sarasota, Fla.

LEARN ELECTRONIC ORGAN SERVICING at home. All Makes including transistors. Experimental kit—troubleshooting. Accredited NHSC. Free Booklet. NILES BRYANT SCHOOL, 3631 Stockton, Dept. A, Sacramento 20, Calif.

HIGHLY—effective home study review for FCC commercial phone exams. Free literature! COOK'S SCHOOL OF ELECTRONICS, P.O. Box 10634, Jackson, Miss. 39209.

PROFESSIONAL Engineering, Electronics. Free Prospectus. CIST, Suite 674, 263 Adelaide Street, West, Toronto, Canada.

FCC LICENSE THROUGH TAPE RECORDED INSTRUCTION. Bob Johnson Audio-Visual Training, 1060D Duncan, Manhattan Beach, California 90266.

TUBES

BEFORE you buy receiving tubes, Transistors, Diodes, Electronic Components and Accessories... send for Giant Free Zalytron Current Catalog, featuring Standard Brand Tubes: RCA, GE, etc.—all Brand new premium quality individually boxed. One year guarantee—all at biggest discounts in America! We serve professional servicemen, hobbyists, experimenters, engineers, technicians. Why pay more? Zalytron Tube Corp., 469-W Jericho Turnpike, Mineola, N.Y. 11502.

FREE Catalog. Electronic parts, tubes. Wholesale. Thousands of items. Unbeatable prices. Arcturus Electronics ZD, 502-22 St., Union City, N.J. 07087.

TUBES, SEMICONDUCTORS, ELECTRONIC EQUIPMENT & COMPONENTS. Quality merchandise only! Serving engineers, purchasing agents, TV/Hifi servicemen and hams for 16 years. Write for catalog or call WA 5-7000. BARRY ELECTRONICS, 512 Broadway, New York, N.Y. 10012.

TUBES—33¢ each. Year guarantee. Tuner Cleaner \$1.09. Free catalog. Cornell, 4213-W University, San Diego, Calif. 92105.

WANTED

QUICKSILVER. Platinum, Silver, Gold. Ores Analyzed. Free Circular. Mercury Terminal. Norwood, Mass.

CASH Paid! Sell your surplus electronic TUBES. (Want UNUSED, CLEAN Radio/TV Receiving, Transmitting, Special Purpose, Magnetrons, Klystrons, Broadcast Types.) Want military and commercial Lab/Test Equipment. Want commercial Ham Receivers and Transmitters. For a Fair Deal Write: BARRY ELECTRONICS, 512 Broadway, New York, N.Y. 10012 (WA 5-7000)

\$7.95



Dial telephone Special. Factory re-conditioned. Complete, guaranteed. Add \$1.00 if plug required. Shipments F.O.B. Waymart. Write for complete telephone list.

SURPLUS SAVING CENTER

Dept. EW116 Waymart, Pa. 18472

FAMOUS BC-645 TRANSCEIVER

15 Tubes 435 to 500 Mc

can be modified for 2-way communication, voice or code, on ham band 420-450 mc. citizens radio 400-470 mc. fixed and mobile 450-460 mc. television experimental 470-500 mc. 15 tubes (tubes alone worth more than sale price!); 4-7F7, 4-7H7, 2-7E8, 2-6ZF5, 2-955 and 1-WE-318A. Now covers 480 to 490 mc. Brand new BC-645 with tubes, less power supply in factory carton. Shipping weight 25 lbs. SPECIAL!

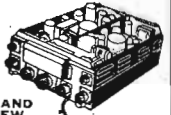

PE-101C Dynamotor, 12/24W input	\$6.95
UHF Antenna Assembly	2.45
Complete Set of 10 Plugs	5.50
Control Box	2.25

SPECIAL "PACKAGE" OFFER: BC-645 Transceiver, Dynamotor and all accessories above. COMPLETE, BRAND NEW, White Stocks Last. **\$26.95**

AN/APR-4Y FM & AM RECEIVER "FB" FOR SATELLITE TRACKING!



High precision lab instrument, suitable for monitoring and measuring frequency and relative signal strength of signals from 38 to 4000 Mc. in 5 tuning ranges. For 110 volt 60 cycle AC operation, built-in power supply. Original circuit diagram included. Checked out perfect. LIKE NEW

TN-19 TUNING UNIT for above, continuous tuning 975 to 2200 Kc, just right for 196 Mc. Satellite Frequency and other current Ham activity. Checked out, perfect. **\$59.50**
Other tuning units for above, TN-16, TN-17, TN-18, TN-54 in stock. **\$25.00** P. U. R.

BC-929 3-inch Scope, with all tubes, LIKE NEW. **\$16.95**
Conversion instructions, with diagram for 110 V AC operation. **\$.65**

SCR-522 2 METER TRANSMITTER-RECEIVER VHF Transmitter-Receiver, 100-156 Mc. 4-channels. Xtal. controlled. Amplitude modulated voice. Complete with all 18 tubes, top rack and metal case. Excellent. **\$39.50**

BC-221 FREQUENCY METER Equipped with original calibration charts. 125Kc. to 20,000 Kc. with crystal check points in all ranges. Excel. Used with all tubes, original calibration Book and Crystal. CHECKED OUT. Unmodified. **\$79.50**

BC-221 1000 Kc Crystal Brand New. **\$5.50**
BC-221 FREQ. METER CASE, aluminum, with volt. reg. supply. Shock mounted. BRAND NEW. **\$13.95**

LM Freq. Meter, Modulated, 125 Kc to 20,000 Kc. With Calibration Book, Like New. **\$79.50**
As above, less Calib. Book, exc. used. **\$34.50**

ARR-1S Collins Receiver, 1.5 to 18.5 Mc. Tunable, with Collins PTO and calibrator (written up in '73" mag.). Complete with tubes, Like New. **\$88.50**

BC1206-C BEACON RECEIVER 195 to 420 Kc, made by Setchel-Carlson. Works on 24-28 volts DC, 135 Kc. IF. Complete with 5 tubes. Size 4" x 4" x 6". Wt. 4 lbs. NEW. **\$12.95**
USED **\$9.95**

24 V DC POWER SUPPLY (ABC) Setchel-Carlson Model 24. INPUT: 24 VDC at 8 Amp. OUTPUT: 1.5 V at 3 A, 65 V at 0.10 A, and -6 V 7"x4"x4". Wt. 4 lbs. Like New, Checked out. **\$6.95**

EE-8 FIELD PHONES

Checked out, perfect working order. Complete with all parts. Excellent Condition. LIKE NEW! Each **\$16.95**

SCR-274 COMMAND EQUIPMENT

Type	Description	TUBES	Like New	BRAND NEW
BC-453 Receiver	19-550 Kc.	\$14.95	\$18.95
BC-454 Receiver	3-6 Mc.	\$16.50	\$21.50
BC-455 Receiver	6-9 Mc.	\$14.95	\$19.50
BC946 Receiver	550-1500 Kc. Complete with all tubes, Like New, in original packing	\$48.50	\$54.50
1.5 to 3 Mc. Receiver	Brand New	\$24.50	\$24.50

110 Volt AC Power Supply for all 274 N and ARC-5 Receivers. Complete with metal case, instructions. Factory wired, tested, ready to operate. **\$12.50**
SPUNDED TUNING KNOB for 274-N and ARC-5 RECEIVERS. Fits BC-453, BC-454 and ARC-5 others. Only **49¢**

2.1 to 3 Mc. Transmitter, Brand New	\$12.95
BC-458 TRANSMITTER—5.3 to 7 Mc. Complete with all tubes & crystal	\$12.95
BRAND NEW	\$8.95
Like New	\$8.95
BC-459 TRANSMITTER—7 to 9 Mc. Complete with tubes & crystal	\$19.50
Like New	\$19.50
BC-696 TRANSMITTER 3-4 Mc Complete with all Tubes & Crystal, Brand New	\$16.95
Like New	\$12.95
BC-456 Modulator	\$2.75 NEW
ALL ACCESSORIES AVAILABLE FOR ABOVE	

SCR-625 MINE DETECTOR Complete portable outfit in original packing, with all accessories. Excellent. Used. **\$32.50**

AN/ARR-2 Receiver, 234-258 Mc. Complete with 11 tubes, Brand New. **\$11.95**
Exc. Used **\$ 7.95**

2-Volt Willard Storage Battery, 20 Amp. Hr. Model 20-2. 3"x4"x5 1/2" high. Brand New. **\$2.79**
6-Volt Willard Midget Storage Battery, 3 Amp. Hr. 3-5/8"x1-13/16"x2-3/8". Brand New **\$2.95**

Please include 25% Deposit with order—Balance C.O.D., or Remittance in Full. 50¢ Handling Charges on all orders under \$5.00. All shipments F.O.B. Our Warehouse, N.Y.C. All Merchandise subject to Prior Sale and Price Change. For NEW COMPLETE CATALOG, send 25¢, refunded with first order!

G & G RADIO SUPPLY CO.

Telephone: (212) CO 7-4605
77 Leonard St. New York, N.Y. 10013

SPECIAL SALES

SPECIAL INTRODUCTORY OFFER

15 EPOXY RECTIFIERS WITH EVERY \$5.00 PURCHASE. MANY OVER 600 PIV. NO SHORTS OR OPENS FET'S "N" CHANNEL TYPE SIMILAR TO C-610 USED AS AMP, SWITCH, CHOPPER—VERY HIGH INPUT Z \$1.25 EACH

P.O. BOX 74
SOMERVILLE, MASS. 02143

SILICON POWER RECTIFIERS			5A INSUL BASE			TOP HAT & EPOXY 750 MA		
PRV	3A	20A	PRV			PRV		
50	.05	.20	50	.10		50	.05	
100	.10	.40	100	.20		100	.07	
200	.20	.60	200	.40		200	.09	
400	.25	.80	400	.60		400	.12	
600	.35	1.20	600	1.00		600	.20	
800	.45	1.50	800	1.25		800	.25	
1000	.65					1000	.50	
						1200	.65	
						1400	.85	

6"x9" speakers 20 ohms 1.5 oz. magnet . . . \$2.50 ea
 4" speakers 3.2 ohms 1 oz. magnet . . . \$1.25 ea
 2.5" speakers 10 ohms . . . 2/\$1.00
 Dual 1 megohm potentiometers with 6 & 12 volt off-on switches . . . 4/\$1.00
 24 volt 60 cycle 6 pole (3 open, 3 closed) 2 throw 15 amp contactors . . . \$4.00 ea
 455 KC IF Transformers . . . 3/\$1.00
 262 KC IF Transformers . . . 3/\$1.00
 Dual 20MFD at 350 volts electrolytic condensers 3/\$1.00
 28-101 MMF ceramic trimmer condensers . . . 6/\$1.00
 GaAs Varactors, sim to AP-1, AP-6 etc. 70KMC min. at 150 mw . . . \$4.00

Terms: FOB Cambridge, Mass.
 Send check or Money Order
 Include Postage, Average Wt.
 per package 1/2 lb. Allow for C.O.D.
 Minimum Order \$2.00

SEND FOR FREE CATALOG (To Be Available Soon)

CIRCLE NO. 87 ON READER SERVICE CARD

DO-IT-YOURSELF

PROFESSIONAL ELECTRONIC PROJECTS—\$1.00 up. Catalog 25¢. PARKS, Box 25565, Seattle, Wash. 98125.

TAPE & RECORDERS

RENT Stereo Tapes—over 2,500 Different—all major labels—free brochure. Stereo-Parti, 1616—E. W. Terrace Way, Santa Rosa, California.

BEFORE renting Stereo Tapes, try us. Postpaid both ways—no deposit—immediate delivery. Quality—Dependability—Service—Satisfaction—prevail here. If you've been dissatisfied in the past, your initial order will prove this is no idle boast. Free Catalog. Gold Coast Tape Library, Box 2262, Palm Village Station, Hialeah, Fla. 33012.

TAPE RECORDER SALE. Brand new, latest models, \$10.00 above cost. Arkay Sales, 1028-B Commonwealth Ave., Boston, Mass 02215.

TAPE-MATES now offers ALL TAPES—ALL LABELS at TREMENDOUS SAVINGS plus FREE Tape-Mates membership. For FREE brochure write TAPE-MATES, 5727-EW W. Jefferson Blvd., Los Angeles 90016.

STEREO TAPES. Save up to 60% (no membership fees, postpaid anywhere USA). Free 60-page catalog. We discount batteries, recorders, tape accessories. Beware of slogans "not undersold," as the discount information you supply our competitor is usually reported to the factory. SAXITONE, 1776 Columbia Rd., Washington, D. C. 20009.

HI-FI components, tape recorders, sleep learn equipment, tapes. Unusual Values. Free catalog. Dressner, 1523 Jericho Turnpike, New Hyde Park 10, N.Y.

TAPES, TAPE RECORDERS—sold, exchanged. Free catalog. Tower, Lafayette Hill, Pa. 19444.

EXCHANGE STEREO TAPES. Catalog. Art's, 4431 Avocado Street, Hollywood, Calif. 90027.

HIGH FIDELITY

LOW, LOW quotes: all components and recorders. Hi-Fi, Roslyn 9, Penna.

FREE! Send for money saving stereo catalog #E11W and lowest quotations on your individual component, tape recorder or system requirements. Electronic Values Inc., 200 West 20th Street, N.Y., N.Y. 10011.

HI-FI Components, Tape Recorders at guaranteed "We Will Not Be Undersold" prices. 15-day money-back guarantee. Two-year warranty. No Catalog. Quotations Free. Hi-Fidelity Center, 239 (L) East 149th Street, New York 10451.

FREE—\$1.00 Value "Miracle" Record cleaning cloth with every quotation on HIFI EQUIPMENT. Our "ROCK BOTTOM" prices on NAME BRAND amplifiers—tuners—tape-recorders—speakers—FRANCHISED—59 YEARS IN BUSINESS. Write for this month's specials—NOW! Rabson's 57th St., Inc., Dept. 569, 119 W. 57th St., New York, New York 10019.

HIFI speaker system. Small, walnut. Magnificent. \$29.95. TANG, Box 162A, Framingham Ctr., Mass. 01701.

REPAIRS AND SERVICES

TV Tuners Rebuilt and Aligned per manufacturers' specification. Only \$9.50. Any make UHF or VHF. We ship COD Ninety Day written guarantee. Ship complete with tubes or write for free mailing kit and dealer brochure. JW Electronics, Box 51B, Bloomington, Indiana.

RECONING—COMPLETE SPEAKER RECONING SERVICE ANY MAKE. ANY SIZE. MIDWEST SPEAKER SERVICE, 715 N. SHERMAN, INDIANAPOLIS, IND. 46201.

GOVERNMENT SURPLUS

JEEPS Typically From \$53.90. . . Trucks From \$78.40. . . Boats, Typewriters, Airplanes, Electronics Equipment, Photographic Equipment, used, 100,000 Bargains Direct From Government. Complete Sales Directory and Surplus Catalog \$1.00 (Deductible First \$10.00 Order). Surplus Service, Box 820-K, Holland, Michigan 49423.

UNUSUAL BARGAINS

... MANY U.S. GOV'T SURPLUS
 "Balls of Fun" for Kids . . .
 Traffic Stoppers for Stores . . .
 Terrific for Amateur Meteorologists . . .

SURPLUS GIANT WEATHER BALLOONS



At last . . . available again in big 8-ft. diameter. Create a neighborhood sensation. Great backyard fun. Exciting beach attraction. Blow up with vacuum cleaners or auto air hose. Sturdy enough for play; all other uses with reasonable care. (can be punctured by sharp objects.) Filled with helium (available locally) use balloons high in the sky to attract crowds, advertise store sales, announce fair openings, etc. Amateur meteorologists use balloons to measure cloud heights, wind speeds, temperature, pressure, humidity at various heights. Photographers can utilize for low-cost aerial photos. Recent Gov't. surplus of heavy, black, neoprene rubber. . . \$2.00 Ppd. Stock No. 60,568-AK

BATTERIES GUARANTEED RECHARGEABLE FOR 5 YRS.



Use these remarkable space-age Nickel-Cadmium batteries in flashlight, portable radios, toy or flash guns. Obsolete all others! Low-cost kit include compact, highly efficient battery charger and 2 "D" size Ni-Cd batteries guaranteed rechargeable to full power for 5 yrs. Power output remains constant—as with lead-acid cells. Durable, black plastic charger 3 1/2" x 3 1/2" x 1 3/4" dp. plugs into standard wall outlet. Completely charges 1 or 2 "D" or "C" size batteries in 16 hrs. Light shows when unit is charging—will not overcharge.

Stock No. 60,591-AK . . . \$9.95 Ppd.
 Stock No. 60,592-AK (Charger only) . . . \$5.99 Ppd.
 Stock No. 60,593-AK (Two "D" Cells only) . . . \$5.90 Ppd.

Order by Stock No. —
 Check or Money Order—Money-Back Guarantee
 EDMUND SCIENTIFIC CO., BARRINGTON, N.J. 08007

SEND FOR FREE CATALOG "AK"

Completely new 1987 edition. New items, categories, illustrations. 148 easy-to-read pages packed with nearly 4000 unusual items. Enormous selection of Astronomical Telescopes, Microscopes, Binoculars, Magnifiers, Magnets, Lenses, Prisms. Many war surplus items: for hobbyists, experimenters, workshop, factory. Write for catalog "AK". Please include your Zip Code.



Please include your Zip Code.

EDMUND SCIENTIFIC CO., BARRINGTON, NEW JERSEY 08007

CIRCLE NO. 119 ON READER SERVICE CARD

BIG CATALOG

World's "BEST BUYS" in GOV'T. SURPLUS Electronic Equipment

COMMUNICATION RECEIVER—6 BANDS

BC-348 Receiver AM—Six bands 200 to 500 KC. and 1.5 to 18 MC. With crystal phasing, antenna align., CW oscillator, beat. freq. AVC/MVC, audio gain, and dimmer pilot light controls. Also slow and fast tuning with large fan dial. Phone and speaker jacks. With tubes: 1/6J7, 3/6K7, 1/6C5, 1/6K6, 1/6B8, & 1/6F7. Voltage required: 24 volts for filament & pilot light and 220 VDC @ 70 MA. for high voltage. Size: 18 x 10 1/2 x 9 1/2". Wt.: 40 lbs.

PRICES:

Used, less Dynamotor . . . \$69.50
 Used, less Dynamotor—Checked for Operation . . . 79.50
 DM-28 Dynamotor—28 VDC . . . Used: 4.95
 FT-154 Shock Mounting Base . . . 2.75
 PLQ-103 Plug for rear of Receiver . . . 2.50
 AC POWER SUPPLY, With Speaker, for BC-348: 115 Volt 60 cycle supply with speaker housed in black crackle case with connecting cable and plug, ready to operate. Size: 10 x 10 x 6". Wt.: 15 lbs. No. PS-348 . . . \$18.95

TG-34A KEYS



Automatic unit for reproducing audible code practice signals previously recorded in ink on paper tapes. Complete with speaker and phone jack for plugging into head-set. Variable speed motor control to 25 WPM. Keying oscillator for use with hand key. Complete portable unit with Tubes and operating Manual.

New: \$24.95—Used: \$19.95

FOR BIG CATALOG—SEND 25¢ (stamps or coin) and receive 50¢ CREDIT on your order!

ADDRESS DEPT. EW

FAIR RADIO SALES
 1016 E. EUREKA • Box 1105 • LIMA, OHIO 45802

RECORDS

REPLACE worn LP Jackets—White 20¢, Colors 25¢. Min Shipment 20, Samples 50¢, Records, Hillburn P.O., New York.

DORIC COMBO ORGAN RECORD. Hear the swinging sounds for 25¢, Doric Organs, Box 1, Convent, N.J. 07961.

MUSIC

POEMS wanted for songs. Send poems. Crown Music, 49-EL West 32, New York 1.

PRINTING

BUSINESS CARDS \$3.95 thousand postpaid. Letterheads, envelopes, all raised printing. Samples. Hill & Hill Co., 1254-ZD Gardenia, Houston, Texas 77018.

EMBOSSED business cards \$2.99—1000. Free samples. Gables, 405N Clifton, Glenshaw, Pa. 15116.

STAMPS

STAMPS FREE! New issues—New countries—Triangles—ROCKETS—OLYMPICS — SCOUTS—BIRDS—FLOWERS—ANIMALS—ALSO Old Canadian and U. S. Stamps. Plus complete illustrated Canadian Stamp Catalog. Send 10¢ for mailing. GRAY STAMP COMPANY, Dept. Z2, Toronto, Canada.

BOOKS

CANADIANS—Fabulous Electronic Book Catalog—Listing over 500 Titles—Free—Books, Box 796A, Montreal.

REPARACIÓN De Motores Eléctricos (Dos Volúmenes) \$16.00. INSTALACIONES ELECTRICAS \$9.00, catalog 25¢. Books in Spanish. Burke Associates, Manchester, Mass.

AUTHORS' SERVICES

AUTHORS! Learn how to have your book published, promoted, distributed. FREE booklet "ZD," Vantage, 120 West 31 St., New York 1.

SONGWRITERS WANTED. Send songs for recordings—royalty contract. Tin Pan Alley, 1650-H Broadway, New York 10019.

WANTED WRITERS! Short stories, articles, books, plays, poetry. Will help place, sell your work. Write today, free particulars! Literary Agent Mead, Dept. C-45, 915 Broadway, New York 10, N.Y.

PHOTOGRAPHY—FILM, EQUIPMENT, SERVICES

MEDICAL FILM—Adults only—"Childbirth" one reel, 8mm \$7.50; 16mm \$14.95. International W, Greenvale, Long Island, New York.

SCIENCE Bargains—Request Free Giant Catalog "CJ"—148 pages—Astronomical Telescopes, Microscopes, Lenses, Binoculars, Kits, Parts, War Surplus bargains. Edmund Scientific Co., Barrington, New Jersey.

EDUCATIONAL OPPORTUNITIES

LEARN While Asleep, hypnotize with your recorder, phonograph. Astonishing details, sensational catalog free! Sleep-Learning Association, Box 24-ZD, Olympia, Washington.

LEARN while asleep. Remarkable, scientific, 92% effective. Details free. ASR Foundation, Box 721, Dept. e.g., Lexington, Kentucky.

USED Correspondence Courses and Books sold and rented. Money back guarantee. Catalog free. (Courses Bought). Lee Mountain, Pisgah, Alabama.

INVENTIONS WANTED

INVENTIONS—IDEAS developed: Cash/Royalty Sales. Member: United States Chamber Commerce. Raymond Lee, 130-G West 42nd, New York City 10036.

FREE

\$25 FREE WORTH OF

- Transistors
- Rectifiers
- Condensers
- Diodes
- Knobs
- Coils, etc.

Radio, TV Parts. Add 25¢ for handling

PLUS

CHOOSE **\$1** ITEM

Check Here **ANY 1 FREE**

BOTH "GIFTS" FREE WITH \$10.00 ORDERS

WORLD'S MOST POPULAR \$1 PARTS PAKS

- 3 INFRA-RED DETECTORS, with leads\$1
- \$25 SURPRISE PAK: transistors, rect, diodes, etc. \$1
- 40 PRECISION RESISTORS, 1/2, 1, 2W; 1% values \$1
- 30 CORNING "LOW NOISE" resistors, 5% too! \$1
- 60 TUBULAR CONDENSERS, to .5mf, to 1KV, asst \$1
- 40 DISC CONDENSERS, 27 mmf to .05 mf to 1KV \$1
- 60 TUBE SOCKETS, receptacles, plugs, audio, etc. \$1
- 30 POWER RESISTORS, 5 to 50W, to 24K ohms\$1
- 50 MICA CONDENSERS, to .1mf, silvers too!\$1
- 10 VOLUME CONTROLS, to 1 meg, switch too!\$1
- 10 ELECTROLYTICS, to 500mf, asst FP & tubulars \$1
- 50 RADIO & TV KNOBS, asst. colors & styles\$1
- 10 TRANSISTOR ELECTROLYTICS: 10 mf to 500 mf \$1
- 50 COILS & CHOKES, if, rf, ant, osc, & more\$1
- 35 TWO WATTERS, asst incl: A.B., 5% too!\$1
- 75 HALF WATTERS, asst incl: A.B., 5% too!\$1
- 60 HI-Q RESISTORS, 1/2, 1, 2W, 1% & 5% values \$1
- 10 PHONO PLUG & JACK SETS, tuners, amps\$1
- 10 TUBULAR ELECTROLYTICS, to 500 mf\$1
- INFRA-RED PHOTO DETECTOR TRANSDUCER\$1
- INFRA-RED PARABOLIC REFLECTOR & FILTER\$1
- 40 WORLD'S SMALLEST COND., to .05mf\$1
- 4 TRANSISTOR TRANSFORMERS, asst. worth \$25 \$1
- 2 CLAIREX PHOTO ELECTRIC CELL, CL607\$1
- 60 CERAMIC CONDENSERS, discs, npo's, to .05\$1
- 40 "TINY" RESISTORS, 1/10W, 5% too!\$1
- 10 TRANSISTOR SOCKETS for pnp-npn transistors \$1
- 30 MOLDED COND'S, mylar, porc, black beauty \$1

FIELD-EFFECT TRANSISTOR

80MC • **DICKSON** • 4 1/2 Vacuum Tube Equivalent

LOW NOISE FETS

- VFO's, N-channel
- oscillators, WORTH \$24
- amplifier
- infrared, \$195 with spec sheet.

TO18 similar to 2N3085 2N3087 2N3089

FACTORY TESTED SEMI-KON-DUCTORS

- 3 2N706 500MW, 300MC NPN PLANAR, TO-18\$1
- 4 2N35 TRANSISTORS, npn, by Sylvania, TO22\$1
- 4 2N255 POWER TRANSISTOR EQUALS, TO3 case \$1
- 2—500 MC, 2N708 NPN Silicon planar TO46\$1
- 15 NPN TRANSISTORS, 2N35, 170, 440, no test\$1
- 85 WATT 2N424 PLANAR, silicon, TO-53 npn, . . . \$1
- 10 NPN SWITCHING TRANSISTORS, 2N338, 440\$1
- 25 ZENERS GLASS SILICON DIODES, no test\$1
- 2 "TINY" 2N1613 2W, 100MC, TO46 case, npn \$1
- 15 PNP TRANSISTORS, CK722, 2N35, 107, no test \$1
- 4 BIDIRECTIONAL TRANSISTORS, 2N1641 types ..\$1
- 3 2N711 300MW, 300 MC, PNP MESA, TO18\$1

FIRST TIME IN U.S.A.!

"ONE PRICE" SCRS!

check the proper amp and PRV blocks.

	<input type="checkbox"/> 7-amp	<input type="checkbox"/> 16-amp	<input type="checkbox"/> 25-amp
PRV	Sale	PRV	Sale
50	55¢	600	3.35
100	75¢	800	4.50
200	1.35	1000	5.59
400	2.25	1200	5.95

NEW FACTORY TESTED

SILICON POWER STUD RECTIFIERS

AMPS	25 PIV	50 PIV	100 PIV	200 PIV
3	5¢	7¢	12¢	19¢
15	15¢	22¢	40¢	65¢
35	39¢	50¢	75¢	1.19
AMPS	400 PIV	600 PIV	800 PIV	1000 PIV
3	25¢	35¢	45¢	69¢
15	90¢	1.35	1.59	1.79
35	1.90	2.50	2.75	2.95

750 MIL TOP HAT AND EPOXIES

PIV	Sale	PIV	Sale	PIV	Sale
50	5¢	600	19¢	1400	95¢
100	7¢	800	29¢	1600	1.10
200	9¢	1000	51¢	1800	1.35
400	13¢	1200	69¢	2000	1.50

- 30 TRANSISTORS, rf, lf, audio osc-ifs, TO5 no test \$1
- 3 2-WATT PLANAR TRANS'RS, 2N697, 100mcnpn \$1
- 4 2N33 6 NPN SILICON transistors, Transistron \$1
- 10 ZENERS REFERENCES stud, asst types\$1
- 25 GERMANIUM & SILICON DIODES, no test\$1
- 25 TOP HAT RECTIFIERS, silicon, 750ma, no test \$1
- 10 FAMOUS CK722 TRANSISTORS, npn no test\$1
- 10 30-MC TRANSISTORS, silicon, TO18, no test \$1
- 3—2N705 MESA, 300 mc, 300 mw, npn, TO18.....\$1
- 10 2-6amp RECT's, studs, silicon, 50 to 400 V\$1
- 10 PNP SWITCHING TRANSISTORS, 2N404, no test ..\$1

CIRCLE NO. 95 ON READER SERVICE CARD

MOTOROLA TRANSISTOR 2N1100 \$195

15-AMP BVcBO 100 Volts

1. AMP 800 PRV

RECTIFIERS \$1

10¢ FOR OUR "XMAS" BARGAIN CATALOG ON: Semiconductors Poly Paks Parts

POLY PAKS

TERMS: send check, money order, include postage—avg. wt. per pak 1 lb. Rated, net 30 days. COD'S 25¢

P.O. BOX 942 R. SO. LYNNFIELD, MASS. "PAK-KING" OF THE WORLD

INVENTORS. We will develop, help sell your idea or invention, patented or unpatented. Our national manufacturer clients are urgently seeking new items for outright cash sale or royalties. Financial assistance available. 10 years proven performance. For free information, write Dept. 42, Wall Street Invention Brokerage, 79 Wall Street, New York 5, N.Y.

INVENTORS! Promotion, protection, search service. Free forms, information; New York Invention Service, Dept. 13, 160 Broadway, New York 10038.

INVENTIONS WANTED. Financial Assistance. Free protection forms, information: Contact: International Invention Institute, Dept. 31; 160 Broadway, New York, N.Y. 10038.

BUSINESS OPPORTUNITIES

I MADE \$40,000.00 YEAR by mailorder! Helped others make money! Start with \$10.00—Free proof. Torrey, Box 63566-N, Oklahoma City, Oklahoma; 73106.

FREE BOOK "990 Successful, Little-Known Businesses." Work home! Plymouth-945K, Brooklyn, New York 11218.

INVESTIGATE Accidents—Earn \$750 to \$1,400 monthly. Men urgently needed. Car furnished. Business expenses paid. No selling. No college education necessary. Pick own job location. Investigate full time. Or earn \$6.44 hour spare time. Write for Free Literature. No obligation. Universal, CZ-11, 6801 Hillcrest, Dallas, Texas 75205.

CITIZENS BAND Radio Dealerships Available. Sell Full or Part Time. Knox Electronic, Dept. 274, Galesburg, Ill. 61401.

FREE CATALOGS. Repair air conditioning, refrigeration. Tools, supplies, full instructions. Doolco, 2016 Canton, Dallas, Texas 75201.

YOUR OPINIONS \$10 HOUR. No Skill. Details from Research, ZD2, Box 669, Mineola, N.Y. 11501.

EMPLOYMENT INFORMATION

FOREIGN and USA job opportunities available now. Construction, all trades. Earnings to \$2,000.00 monthly. Paid overtime, travel, bonuses. Write: Universal Employment, Woodbridge, Connecticut 06525.

GET IT from GOODHEART!

EVERYTHING UNCONDITIONALLY GUARANTEED!

ALL-BAND SSB RCVR BARGAIN: Hallcrafters R-45/ARR-7 550 kc to 43 mc continuous. Voice, CW, MCW, aligned, grtd, w/book; 2-RF, 2-IF's, S-meter; noise Intr: 3 xtl, 3 non-xtl 149.50 selectivity choices, Less pwr sply. 60 cy pwr sply: \$30. SSB product detector: \$20

TIME PAY PLAN: Any purchase totaling \$160.00 or more, down payment only... **10%**

DZ-1 Superhet rcvr 15-70 & 100-1500 kc. 89.50
 R-23/ARC-5 Command rcvr 190-550 kc. 14.95
 A.R.C. 12 #22 Command rcvr 540-1600 kc. 17.95
 ARR-5 rcvr, 60 cy, am/fm, 27-140 mc. 149.50
 APR-4Y AM/FM Rcvr mod. to 115 v 50/60 cy, with pwr plug, book, tuners 38-1000 mc. 250.00
 CV-253/ALR Tuner brand new 38-1000 mc. 250.00
 P.U.R. for tuners 975-2200 and 2175-4000 mc.
 URR-13 Rcvr 222.75-404 mc AM, w/book 249.50
 Handbook for AN/URIL Rcvr 10.00
 Handbooks for AN/ARC-3 or for ART-13 10.00
 Other Handbooks, or Schematics, ask for them!
 RA-62-B is AC pwr sply for SCR-522, only 17.95
 TDQ xmtr 45 W Po A2, A3, 115-150 mc. 295.00
 TDZ xmtr 30 W Po A2, A3, 225-400 mc. 495.00
 LM-14 freq. meter, .01% 15 kc-20 mc 57.50
 TS-323/UR freq. meter 20-430 mc., .001% 169.50
 Gertsch FM-3 w/AC pwr, 1-1000 mc. 0.001% 395.00

Hewl-Pack #150A 5" scope, DC to 10 mc certified w/ #153A differential ampl. plug-in 535.00
 With #151B hi-gain plug-in 5 mv/cm 545.00
 With #152A dual-trace plug-in 565.00
 DuMont #33 dual-beam scope, DC-150 kc. 199.50
 Tekt. 511AD, 5 cy to 10 mc, 30 mv/cm 225.00
 Tekt. #512, DC to 2 mc, 5 mv/cm 195.00
 Tekt. #514AD, DC to 10 mc, 30 mv/cm 350.00
 Tekt. #531; w/53B & 2-trace 53C, w/certif 795.00

STANDARD SIGNAL GENERATORS

LP: 912 kc to 50 mc, w/pwr sply 199.50
 TS-413/U: 75 kc to 4 mc, xtl calib 279.50
 Gen. Radio 805-C: 16 kc to 50 mc 750.00
 TS-606: .085-40 mc, up to 10W out 995.00
 Meas. Corp Model 80: 2 to 400 mc 375.00
 URM-26: Compact MIL generator 4-408 mc 295.00
 Hewl-Pack 608B: 10 to 400 mc 395.00
 Hewl-Pack 608C: 10 to 430 mc 169.50
 Borg-Warner G201: Same specs as 608D 750.00
 TS-510A: Exact imitation H.P. 608D 950.00
 TS-608: 42-400 mc, up to 10W out 1295.00
 AN/USM-16: AM/FM, xtl calib 10-440 mc 995.00

SEND FOR more info on anything above. SEND FOR list of regulated power supplies at ridiculously low prices. **ASK IF WE HAVE** what you need that you don't find above; this ad lists only 5% of our stock. **WE ALSO BUY! SO TELL US WHAT YOU HAVE.**

R. E. GOODHEART CO. INC.

Box 1220-A, Beverly Hills, Calif. 90213

Phones: Area 213, office 272-5707, messages 275-5342

CIRCLE NO. 114 ON READER SERVICE CARD

HYPNOTISM

FREE Hypnotism, Self-Hypnosis, Sleep Learning. Catalog! Drawer H400, Ruidoso, N.M. 88345.

FREE TRIAL!! Sensational self-hypnosis record kit. Forum, 333-AA11 Michigan, Chicago 60601.

HYPNOTIZE FEMALES!—Unnoticed! Instantly! Nerves! Send \$2.25. Research Enterprises, 29-SN21 Samoset, Woburn, Mass.

REAL ESTATE

FREE Fall-Holidays CATALOG! Big 180 pages! Selected Best thruout the U.S. Thousands of properties described, pictured—Land, Farms, Homes, Businesses—Waterfront, Recreation, Retirement. 66 Years' service, 490 Offices, 36 states Coast to Coast. Mailed **FREE** from the World's Largest! **STROUT REALTY**, 50-ZD, East 42nd St., N.Y. N.Y. 10017.

RUBBER STAMPS

RUBBER ADDRESS STAMP \$1.00. Signature \$2.88. Free catalog, Jackson Products, 1433 Winnemac, Chicago, Ill. 60640.

MISCELLANEOUS

WINEMAKERS: Free illustrated catalog of yeasts, equipment. Semplex, Box 7208, Minneapolis, Minn. 55412.

LEMURIAN VIEWPOINT—Thought-provoking discussions of Universal Truth, man's purpose on earth, reincarnation, and subjects from Lemurian Philosophy. Send for **FREE** copy. Lemurian Fellowship, Dept. 624, Ramona, Calif. 92065.

LEBANON Holy Land Koweit—REMAILING—\$1.00 airmail. Box 5569, Beirut.

BEERS, PEACH BRANDY, WINES—Strongest Formulas, \$2.25. (complete brew supplies hydrometers catalog 10¢)—Research Enterprises, 29-D Samoset, Woburn, Mass.

ELECTRONICS WORLD NOVEMBER 1966

ADVERTISERS INDEX

READER SERVICE NO.	ADVERTISER	PAGE NO.	READER SERVICE NO.	ADVERTISER	PAGE NO.
125	Allied Radio	83, 84	103	Mallory & Co., Inc., P.R.	98
	American Institute of Engineering & Technology	104	102	Milwaukee School of Engineering	16
200	Belden Manufacturing Company	15	101	Motorola Training Institute	98
124	Burstein-Applebee Co.	101	99	Music Associated	60
	Capitol Radio Engineering Institute, The	18, 19, 20, 21	100	Multicore Sales Corp.	85
	Castle TV Tuner Service	104		National Radio Institute	8, 9, 10, 11
123	Cleveland Institute of Electronics	17	98	Olson Electronics, Inc.	105
	Cleveland Institute of Electronics	62, 63, 64, 65	96	PF Reporter	78
	Conar	81	95	Poly Paks	109
78	Crown International	105	81	Precise Electronics	105
121	Delta Products, Inc.	6		RCA Electronic Components and Devices	FOURTH COVER
120	EICO Electronic Instrument Co., Inc.	59	94	RCA Electronic Components and Devices	22
119	Edmund Scientific Co.	108	93	RCA Electronic Components and Devices	79
108	Electro-Voice, Inc.	SECOND COVER		RCA Institutes, Inc.	72, 73, 74, 75
118	Electronic Chemical Corp.	95	92	Radar Devices Manufacturing Corp.	1
117	Electronic Components Co.	106	91	Sams & Co., Howard W.	69
	Fair Radio Sales	108	90	Schober Organ Corporation, The	71
116	Finney Company, The	7	89	Scott, Inc., H.H.	82
	G & G Radio Supply Co.	107	88	Shure Brothers, Inc.	95
114	Goodheart Co. Inc., R.E.	110	87	Solid State Sales	108
113	Grantham School of Electronics	85	86	Sony Corp. of America	61
112	Gregory Electronics Corporation	106	85	Sprague Products Co.	99
	Heath Company	51, 52, 53, 54, 55	79	Surplus Center	107
	Henshaw TV Supply	104		Surplus Saving Center	107
	IBM	77	84	Texas Crystals	81
110	Intercontinental Seaway Products Company	85	97	Triplett Electric Instrument Company	THIRD COVER
109	Jerrold Electronics Corporation	2	83	Tuner Service Corporation	70
107	Johnson Company, E.F.	13		UNIVAC	12
106	Knight-Kit Div., Allied Radio	67	80	University Sound	4
105	Lafayette Radio Electronics	93, 94		Valparaiso Technical Institute	70
	Lampkin Laboratories, Inc.	104	82	Xcelite, Inc.	66
104	Mallory & Co. Inc., P.R.	5			

CLASSIFIED ADVERTISING 106, 107, 108, 109, 110

200,000 OHMS PER VOLT

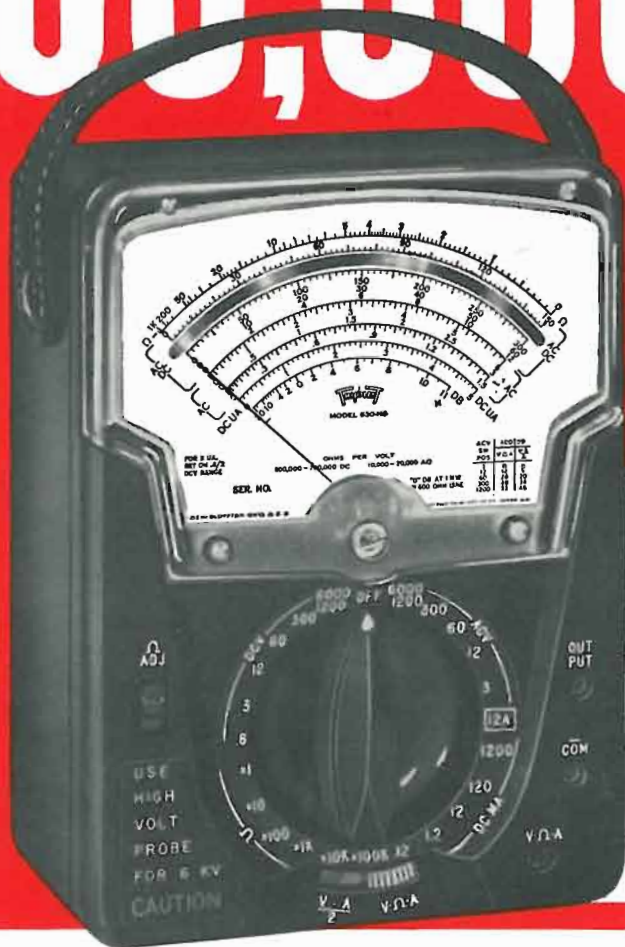

Model 630-NS
VOLT-OHM-MICROAMMETER

TRIPLET SUSPENSION MOVEMENT

*no pivots . . . no jewels . . .
no hair springs . . . thus NO FRICTION.*

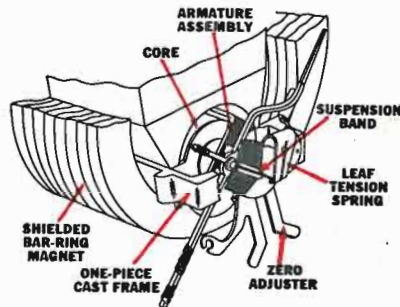

\$100.00
SUGGESTED
U.S.A. USER NET

FACTS MAKE FEATURES

- 1** 200,000 OHMS PER VOLT D.C. for greater accuracy on high resistance circuits. 20,000 OHMS PER VOLT A.C.
- 2** 5 μ A SUSPENSION METER MOVEMENT. No pivots, bearings, hair-springs, or rolling friction. Extremely RUGGED. Greater sensitivity and repeatability.
- 3** 62 Ranges, usable with frequencies through 100 Kc. Temperature compensated. 1½% D.C. ACCURACY, 3% A.C.

Low voltage ranges and high input impedance make the 630-NS especially useful in transistor circuit measurement and testing. Input impedance, at 55 volts D.C. and above, is *higher than most vacuum tube voltmeters.*

The unit is designed to withstand overloads and offers greater reading accuracy. Reads from 0.1 μ A on 5 μ A range. Special resistors are rigidly mounted and directly connected to the switch to form a simplified unit. Carrying cases with stands are priced from \$11.00.

TRIPLET ELECTRICAL INSTRUMENT COMPANY, BLUFFTON, OHIO

CIRCLE NO. 97 ON READER SERVICE CARD

62 RANGES

D.C. VOLTS	0-0.6-3-12-60-300-1200 at 100,000 Ohms/Volt. 0-0.3-1.5-6-30-150-600 at 200,000 Ohms/Volt. 0-0.150 at 60 μ A
A.C. VOLTS	0-3-12-60-300-1200 at 10,000 Ohms/Volt. 0-1.5-6-30-150-600 at 20,000 Ohms/Volt.
DB	-20 to 77 in 10 ranges.
D.C. MICRO-AMPERES	0-5 at 300 MV. 0-60-600 at 150 MV. 0-120 at 300 MV.
D.C. MILLI-AMPERES	0-6-60-600 at 150 MV. 0-1.2-12-120-1200 at 300 MV.
D.C. AMPERES	0-6 at 150 MV. 0-12 at 300 MV.
OHMS	0-1K-10K-100K (4.4-44-440 at center scale)
MEG OHMS	0-1-10-100 (4400-44,000-440,000 Ohms center scale)

OUTPUT: Condenser in series with A.C. Volt ranges.



THE WORLD'S MOST COMPLETE LINE OF V-O-M'S. AVAILABLE FROM YOUR TRIPLET DISTRIBUTOR'S STOCK.

Now in one handbook...the service information you need for 12 makes of color TV sets



TABLE OF CONTENTS

- INTRODUCTION
 HOW TO USE THIS HANDBOOK
 ABBREVIATIONS USED IN THIS HANDBOOK
- Section 1. CHASSIS INDEX
 - CHASSIS LAYOUTS
 - Section 2. PURITY ADJUSTMENTS
 - Section 3. CONVERGENCE ADJUSTMENTS
 - STATIC CONVERGENCE (general)
 - DYNAMIC CONVERGENCE (specific)
 - Section 4. BLACK-AND-WHITE SETUP ADJUSTMENTS
 - Section 5. PHASE AND MATRIX ADJUSTMENTS
 - Section 6. COLOR AFPC FIELD ADJUSTMENTS
 - Section 7. MISCELLANEOUS ADJUSTMENTS
 - Section 8. FUSES AND CIRCUIT BREAKERS
 - Section 9. TEST EQUIPMENT FOR COLOR TV SERVICING
 - Section 10. RECEIVING TUBES FOR COLOR TV

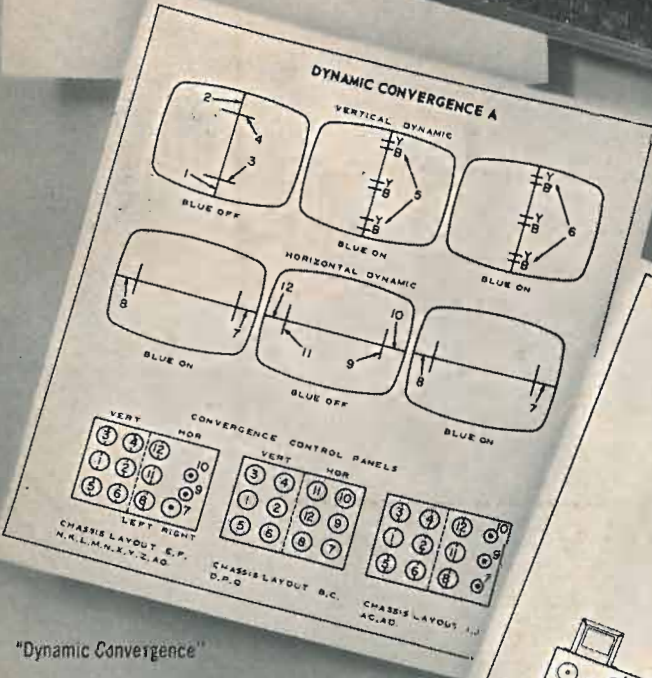

"Dynamic Convergence"

Just look up the chassis number of the set you are working on in the CHASSIS INDEX and you will be guided to the proper sections of the 140-page RCA Color TV Service Handbook. All the information is based on the manufacturer's own service notes. You'll want to carry a copy in your tube caddy on every color TV service call.

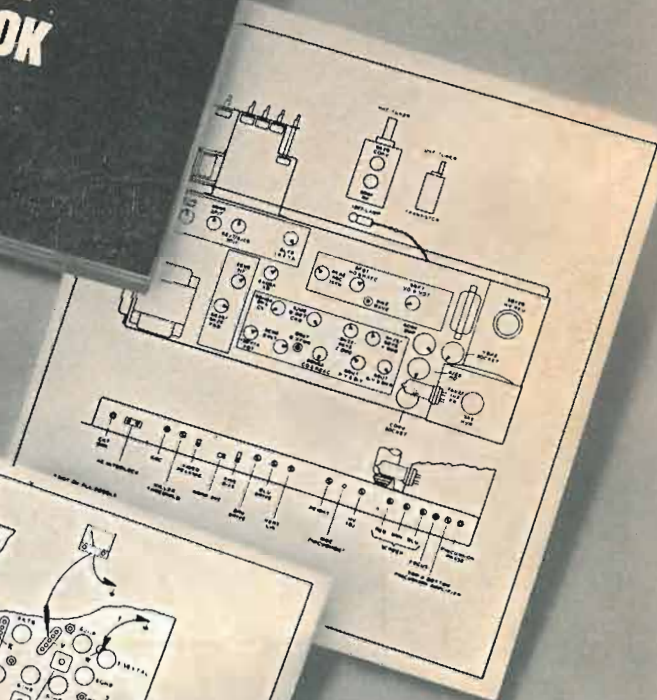

"Chassis Layouts"

"Color AFPC Field Adjustments"

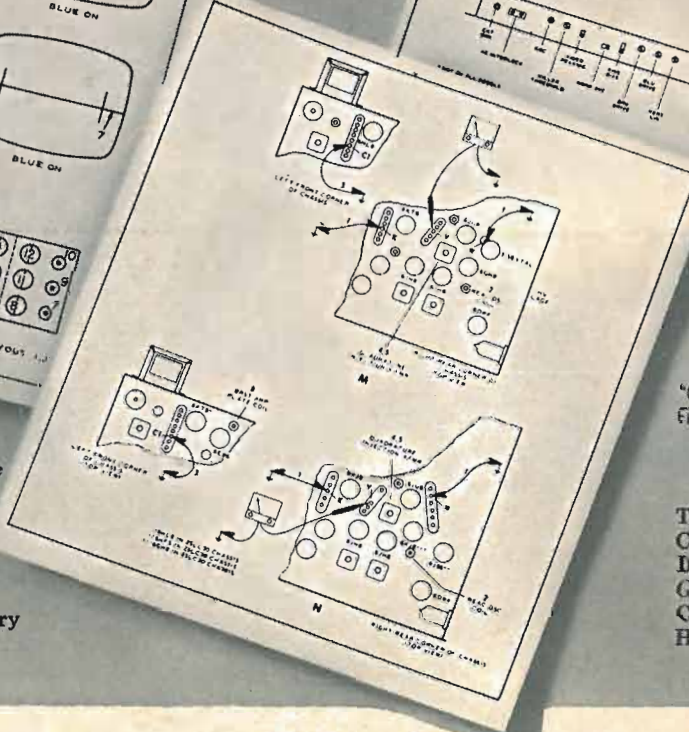

TO KEEP UP WITH COLOR, SEE YOUR RCA DISTRIBUTOR ABOUT GETTING THE RCA COLOR TV SERVICE HANDBOOK (1A1553).

RCA ELECTRONIC COMPONENTS AND DEVICES, HARRISON, N. J.



The Most Trusted Name in Electronics

RCA's personal quality performance program aims for missile-type reliability in commercial receiving tubes. Under this program thousands of RCA people have pledged to strive for error-free performance so that when you replace with RCA receiving tubes you're sure of a satisfied customer.